

REV	ECN NO.	APPD
A	HC-19-0220	ZO

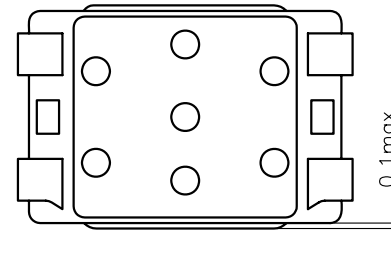

规格 Specifications

额定负荷 Rating	DC 12V/50mA
接触电阻 Contact Resistance	500mΩ max.
绝缘电阻 Insulation resistance	DC100V 60S 100MΩ min.
抗电强度 Dielectric strength	AC250V(50~60HZ) 60S min.
操作力 Operation force	≥100±30gf    ≤190±30gf
寿命试验 Operating Life	100,000 cycles
行程 Travels	0.13±0.05mm

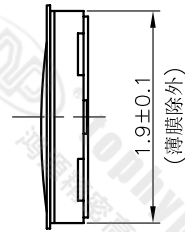
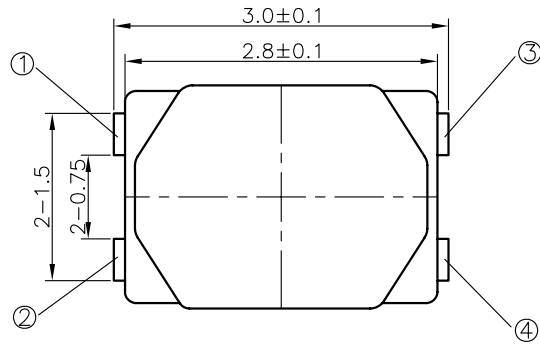
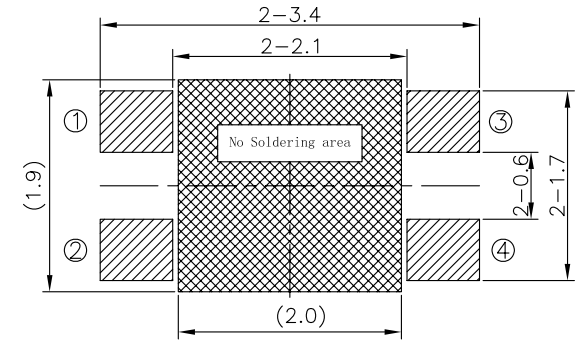
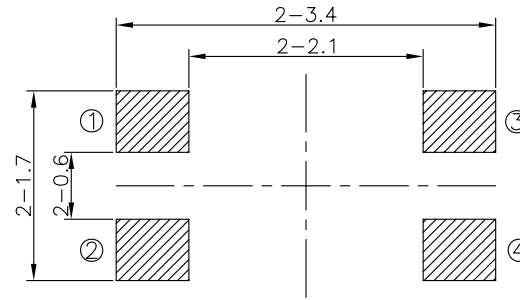
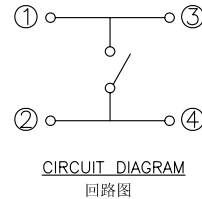
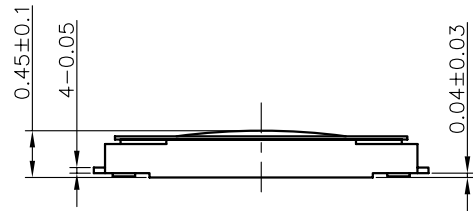

PRODUCT NO. : 1TS028B\*\*\*-\*\*\*-045\* - \*\*

- 轻触开关
- 2. 8X1.9系列
- 外形:
  - A=四脚
  - B=四脚无按柄
- 按点颜色:
- 底座颜色:
- 贴膜颜色:
- 操作力度:
  - 100=100gf
  - 160=160gf
  - 225=225gf
- 初始颜色 则不启用
- 手感:
  - 0=常规(弹片)
  - 1=大手感(弹片)
  - 2=小手感(弹片)
  - 3=特殊手感(弹片)
- 材质:
  - 0=初始材质
  - 1=新增材质
  - 3=3个弹片 依次增加
- 其它:
  - CT=编带(非编带, 不启用)

4	FILM	1	POLYAMIDE	WHITE
3	DOMES	2	SUS301	Ag-PLATED
2	HOUSING	1	POLYAMIDE	BLACK
1	TERMINAL	1	PHOSPHOR BRONZE	Ag-PLATED
ITEM	PART NAME	QUANTITY	MATERIAL	FINISH

X. ± 0.2	X.* ± 0.2*	UNITS	MM	NAME(INTENDED USE) 2.8X1.9 SERIES TACT SWITCHES	HON YUAN HON YUAN PRECISION IND. CO.,LTD. SHENZHEN, CHINA.	
.X ± 0.1	.X* ± 0.1*	MAT'L				
.XX ± 0.01	.XX* ± 0.01*	FINISH		PART NO.(INTENDED USE) 1TS028B***-***-0	TITLE: PRODUCT DRAWNG	
.XXX ± 0.002	.XXX* ± 0.005*		Q'TY		APPD: ZO 12/06'2019	DWG NO.: 1TS028B
THESE DRAWINGS AND SPECIFICATIONS ARE THE PROPERTY OF HON YUAN PRECISION IND. CO., LTD. AND SHALL NOT BE REPRODUCED, COPIED OR USED IN ANY MANNER WITHOUT THE PRIOR WRITTEN CONSENT OF HON YUAN PRECISION IND. CO., LTD.				CHKD: M.H.Li 12/06'2019	DR: Y.Y.Chen 12/06'2019	
				SCALE	SHEET	REV.
				25/1	1/2	A