

規格承認書

PECIFICATION FOR APPROVAL

客戶
CUSTOMER : 立創
項目
ITEM : 贴片式压电无源蜂鸣器 (外部驱动)
型號
TYPE : GSC1325YB-3V4000
描述
DESCRIPTION : L13 x W13 x 2.5 MM 4000Hz 3V ≥75DB 正发音 LCP 材质
客戶料號
CUSTOMER NO. :
規格書號
SPECIFICATION NO. :
版本
EDITION NO. : V1.0
日期
DATE : 2019-12-26

客戶承認

CUSTOMER CONFIRM AND SIGN

檢查 TESTED BY	審核 CHECKED BY	承認 APPROVED BY

東莞市贏海電子有限公司

DONGUAN INGHAI ELECTRONICS CO.,LTD

製作 ISSUED BY	審查 CHECKED BY	確認 APPROVED BY
周明	李林	

地址：廣東省東莞市長安鎮廈邊元灶頭工業區 16-6 號
電話 / TEL: 0769-83060958 傳真 / FAX: 0769-81608993
網址: HTTP://WWW.INGHAI.COM

A. SCOPE

This specification applies SMD piezoelectric buzzer, GSC1325YB-3V4000

B. SPECIFICATION

1	Model No.	GSC1325YB
2	Rated Voltage (Vp-p)	3
3	Operating Voltage (Vp-p)	1~30
4	Resonant Frequency (Hz)	4000
5	Static Capacitance at 100Hz 1V (PF)	16000±30%
6	*Sound Output at 10cm / Rated Voltage / 4000 Hz (dB)	≥75
7	*Current Consumption (mA) at Rated Voltage	≤3
8	Operating Temperature (°C)	-30~+85
9	Storage Temperature (°C)	-40~+85
10	Weight (g)	0.5
11	Housing Material	LCP(Black)
12	RoHS	Yes

Measuring condition

Part shall be measured under a condition (Temperature: 5~35°C, Humidity: 45%~85%R.H., Atmospheric pressure: 860 ~ 1060hPa) unless the standard condition (Temperature: 25±3°C, Humidity: 60±10%R.H. Atmospheric pressure: 860 ~ 1060hPa) is regulated to measure.

C. APPEARANCE DRAWING

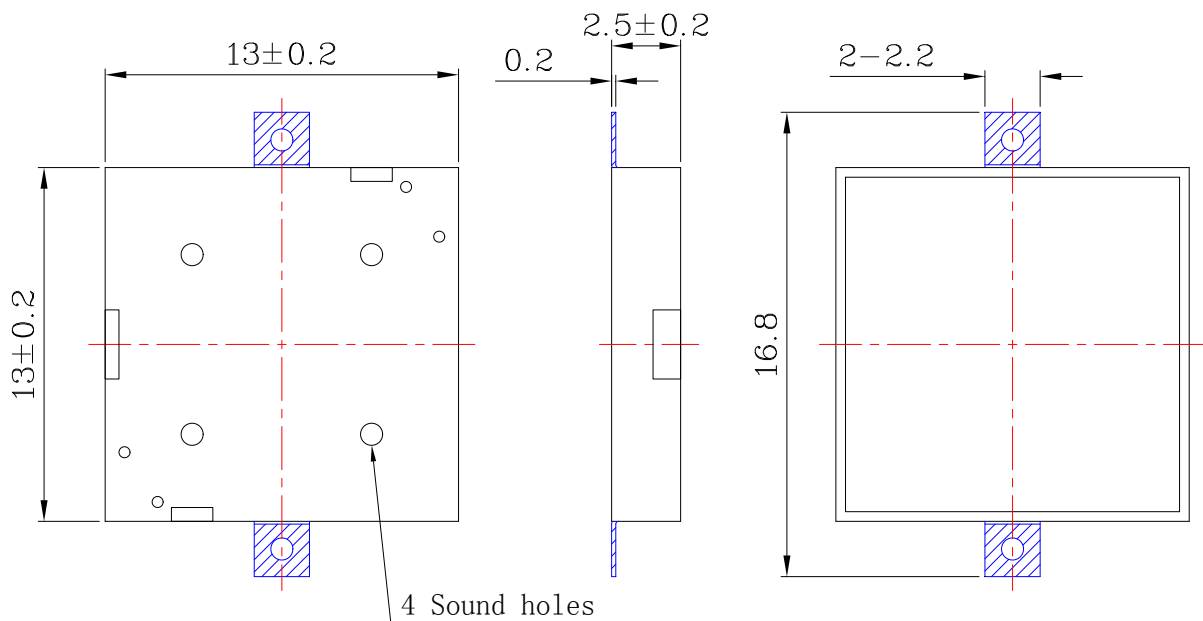

D: TEST METHOD:

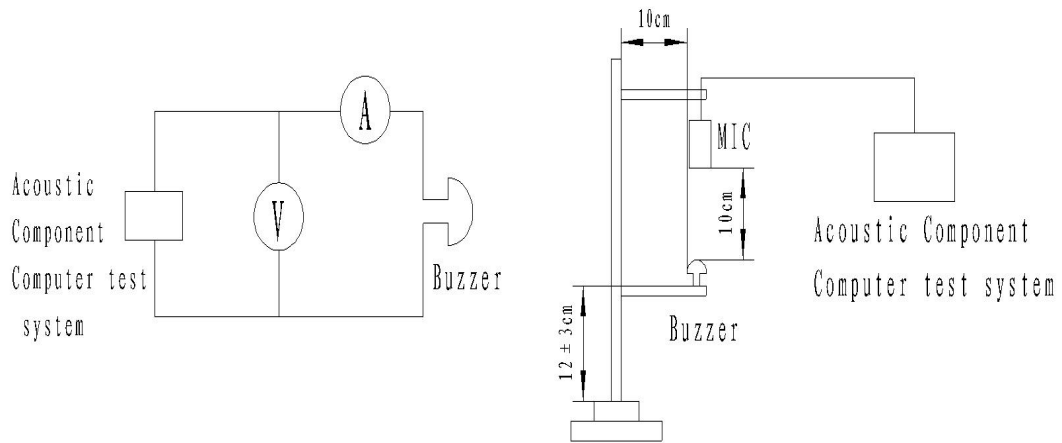

In the measuring test, buzzer is placed as follows:

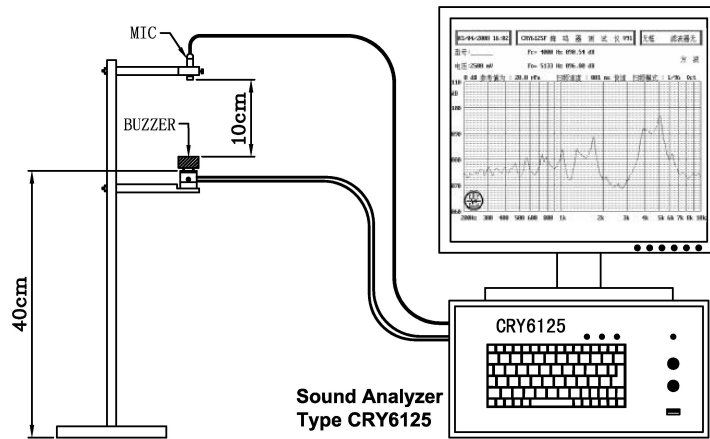

E: FREQUENCY RESPONSE:

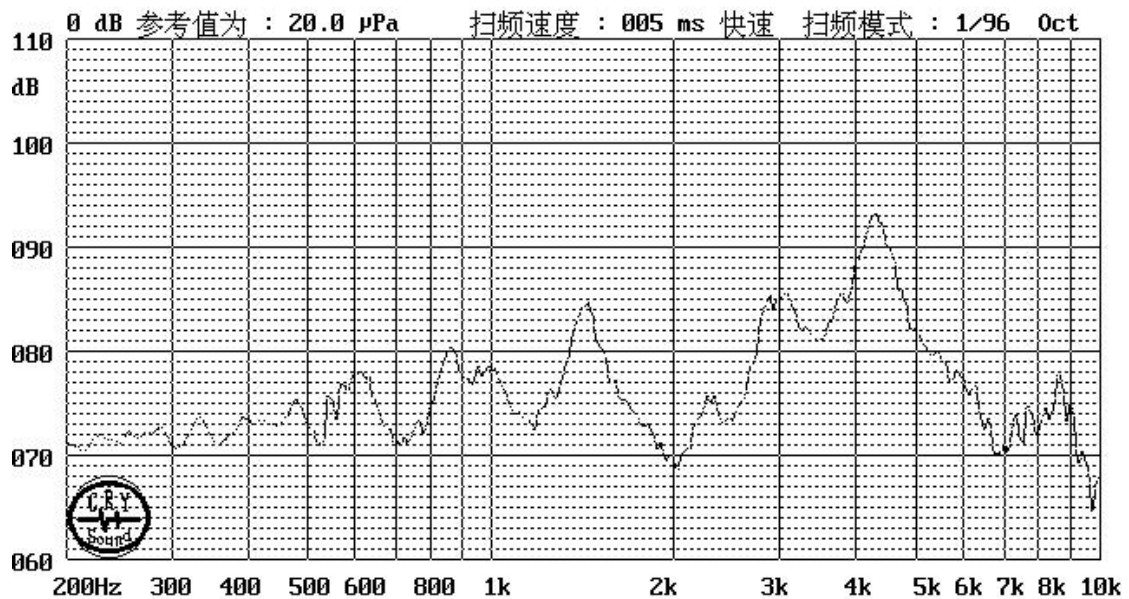

F: Reliability Test

After any following tests the part shall meet specifications without any degradation in appearance and performance except SPL. SPL shall not deviate more than -10 dB from the initial value

1. Ordinary Temperature Life Test

The part shall be subjected to 96 hours at $25 \pm 10^\circ\text{C}$. Input rated voltage Resonant frequency, 1/2 duty Square wave.

2. High Temperature Test

The part shall be capable of with standing a storage temperature of $+85^\circ\text{C}$ for 96 hours.

3. Low Temperature Test

The part shall be capable of with standing a storage temperature of -40°C for 96 hours.

4. Humidity Test

Temperature: $+40^\circ\text{C} \pm 3^\circ\text{C}$ Relative Humidity: 90% ~ 95% Duration: 48 hours and expose to room temperature for 6 hours

5. Temperature Shock Test

Temperature: 85°C /1hour → 25°C /3hours → -30°C /1hour → 25°C /3hours (1cycle)
Total cycle: 10 cycles

6. Drop Test

Standard Packaging From 120mm (Drop on hard wood or board of 5cm thick, three sides, six plain.)

7. Vibration Test

Vibration: 1000cycles /min. Amplitude: 1.5mm, Duration: 1 hour in each 3 axes

Note:

As this product is not protected from foreign material entering, please make sure that any foreign materials (e.g. magnetic powder, washing solvent, flux, corrosive gas) do not enter this product in your production processes. The functional degradation (e.g. SPL down) may occur if foreign material enter it.

G: Reliability Test

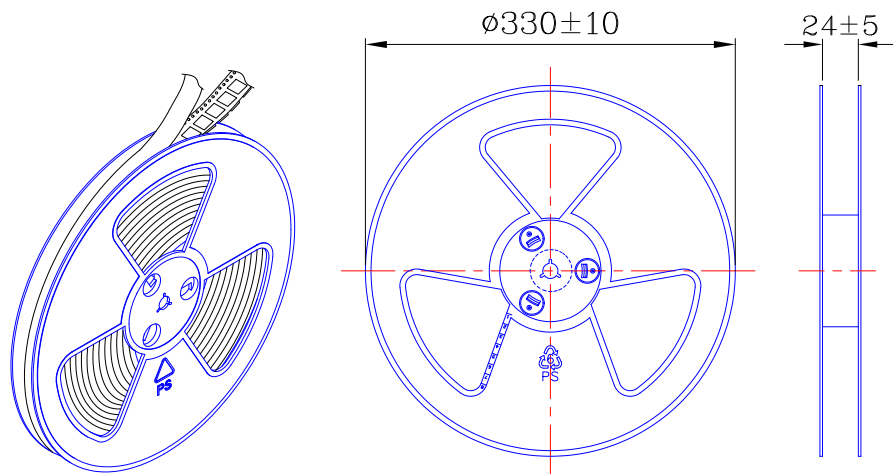

1 Reel : 1000PCS

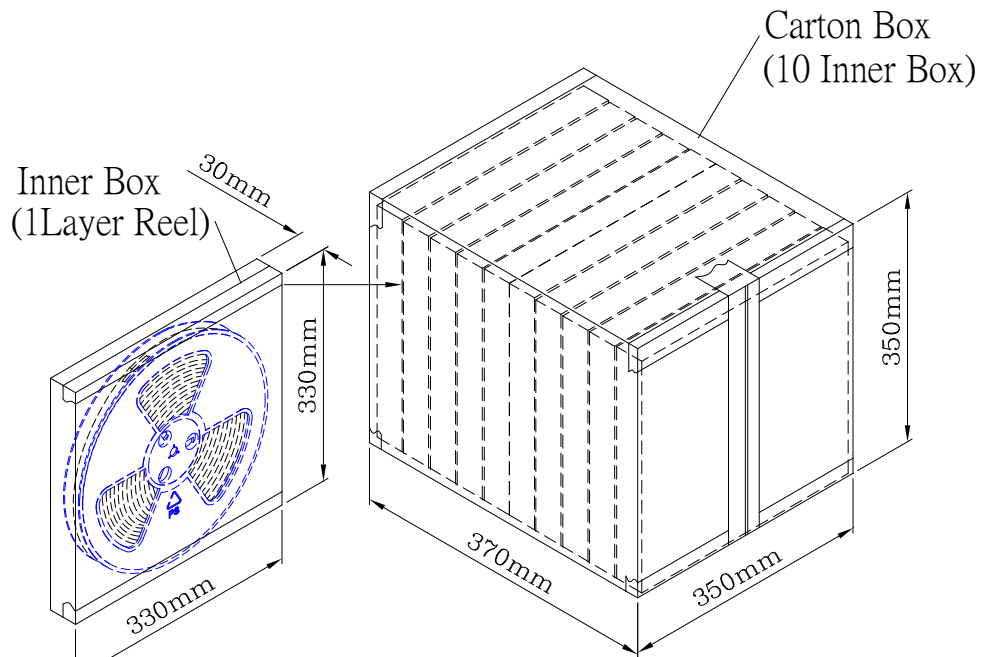
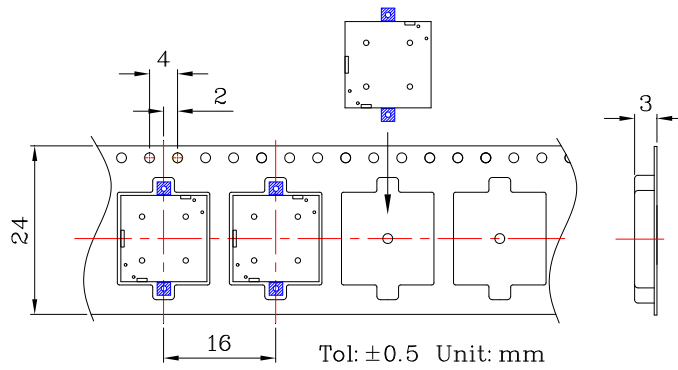

Inner Box	330mmx330mmx30mm	1x1000PCS=1000PCS
Carton Box	350mmx350mmx370mm	10x1000PCS=10,000PCS