



规格书

Aluminum Solid Electrolytic Capacitors

Specification For Approval

客户：天河星	日期：2019.06.27
Customer :	Date:

品名	Item	:	Aluminum Solid Electrolytic Capacitors
型号	Series	:	VPX
版本	Version	:	
物料号	Customer P/N	:	

客户 Customer		
批准 Approved by	研发部 R&D	品保部 QC

供应商 Supplier		
批准 Approved by	审核 Checked by	拟制 Prepared by
孙建	郭静	李碧容

承认书请寄回一份

Please Return One Copy with Your Approval

上海永铭电子股份有限公司

Shanghai Yongming Electronic Co., Ltd.

Tel: 021-33617848 Fax: 021-33617128

Http://www.sh-ymin.com

客户名 Customer	天河星	系列 SERIES	VPX
--------------	-----	--------------	-----

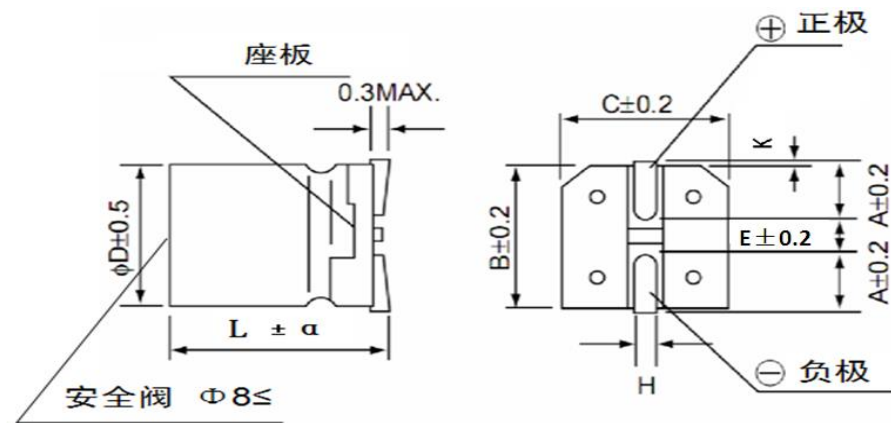

FIG-1

TABLE-1

No	客户物料 编码 Customer Part No	永铭物 料编码 Ymin Part No	额定 电压 Rated Voltage (V.DC)	容量 Capacitance (μ F)	浪涌 电压 Surge Voltage (V.DC)	使用温度 范围 Operating Temp.Range ($^{\circ}$ C)	容量范围 Capacitance Tolerance (%)	损耗 Tan δ (120Hz) (Max) (%)	等效串联电阻 ESR(Ω) at 20 \pm 2 $^{\circ}$ C 100KHz	最大纹波电流 (105 $^{\circ}$ C 100KHz) Max Ripple Current(mA) at 105 $^{\circ}$ C 100KHz	漏电流 Leakage Current (μ A)(2mins reading)	寿命 Life At 105 $^{\circ}$ C (Hours)	尺寸 Dimensions(mm)			外观 Appearance Drawing No.
													ϕD	L	a	
1		VPXC0581E101MVTM	25	100	28.8	-55~+105	-20~+20%	8	0.040	1900	500.0	2000	6.3	5.8	± 0.5	FIG-1
2																
3																
4																
5																
6																
7																
8																

上海永铭电子股份有限公司 Shanghai Yongming Electronic Co.,Ltd.	铝电解电容器承认书 Aluminum Electrolytic Capacitors Specification	商标 
---	--	--

1 概述 SCOPE

本承认书规定了固态铝电解电容器的技术规范。

This admitted that book regulations, the technical specification of solid aluminum electrolytic capacitor.

2 参考标准 APPLICABLE SPECIFICATION

本承认书参考 JISC-5141 和 JISC-5102 制定。

This approval sheet consulted the institute of JISC-5141 and JISC-5102.

3 工作温度范围 OPERATING TEMPERATURE RANGE

工作温度范围是电容器在施加额定工作电压和额定纹波电流的条件下，可以长期可靠工作的环境温度范围。

-55~+105 °C (6.3~100V.DC)

Operating temperature range is the range of ambient temperature at which the capacitors can be operated continuously at rated voltage.

-55~+105 °C (6.3~100V.DC)

4 测试环境 CHARACTERISTICS

如果没有其他规定，标准的测试、检验环境条件如下所示：

环境温度：20°C ±2°C

相对湿度：60±15%

大气压力：86kpa~106kpa

Unless otherwise specified, the standard range of atmospheric conditions for making measurements and tests are as follows.

Ambient temperature : 20°C ±2°C

Relative humidity : 60±15%

Air pressure : 86kpa to 106kpa

5. 产品特性 PRODUCT CHARACTERISTICS

5.1 电气特性 ELECTRICAL CHARACTERISTICS

序号 NO	项目 Item	测试方法 Test method	性能 Performance
5.1.1	额定工作电压 Rated voltage		6.3~100 V.DC
5.1.2	电容量 Capacitance	测试频率：120Hz±10% 测试电路：串联等效电路 测试电压：0.5Vrms Measuring frequency: 120Hz±10% Measuring circuit: Series equivalent circuit Measuring voltage: 0.5Vrms	标称容量 2.2~10000uF -20%~+20% Range of Capacitance: 容量偏差：-20%~+20% Capacitance tolerance: -20%~+20%

名称 Name	03		承认书 Specification	页数 Page	3
版本 Version	03		标准指南 Standard manual		

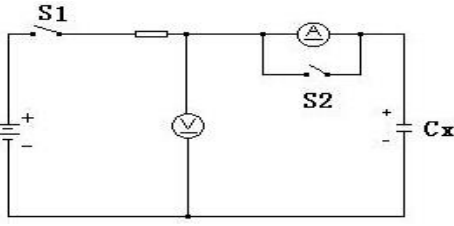
5.1.3	损失角正切值 Dissipation Factor	测试条件与 5.1.2 电容量测试相同 Testing condition are the same as 5.1.2 for capacitance	见表 1 see table 1																		
5.1.4	漏电流 Leakage current	在电容器两端施加额定工作电压，并串联 1000±100Ω 电阻，在施加电压 2 分钟后，测量漏电流。 测试电路如下图： The rated voltage shall be applied across the capacitors and its protective resistor which shall be 1000±100Ω. The leakage current shall then be measured after an electrification period of 2 min.. Measurement circuit  Rs: 保护电阻 (1000±100Ω) Protective resistor(1000±100Ω) : 直流电压表 : DC voltage meter : 直流电流表 : DC AM meter S ₁ : 开关 S ₁ :Switch S ₂ : 电流表保护开关 S ₂ :Protective switch for an ammeter 备注：漏电流测试，C.C 标准设定为 500mA.	施加额定工作电压 2 分钟后 The leakage current shall then be measured after an electrification period of 2 min. LC≤0.2CV 或 280μA 取大者 LC≤0.2CV or 280 whichever is greater LC: 漏电流(μA) C: 容量(μF) V: 额定工作电压(V) LC: Leakage current(μA) C: Capacitance(μF) V: Rated voltage(V)																		
5.1.5	温度特性 Temperature Characteristi	<table border="1" style="width:100%; border-collapse: collapse; text-align: center;"> <thead> <tr> <th>阶段</th> <th>温度</th> <th>时间</th> </tr> </thead> <tbody> <tr> <td>1</td> <td>20±2℃</td> <td>30min</td> </tr> <tr> <td>2</td> <td>-55+0/-3℃</td> <td>120min</td> </tr> <tr> <td>3</td> <td>(15℃~35℃)±2℃</td> <td>15min</td> </tr> <tr> <td>4</td> <td>105+3/-0℃</td> <td>120min</td> </tr> <tr> <td>5</td> <td>20±2℃</td> <td>120min</td> </tr> </tbody> </table> 阶段 1: 测量容量和损失角正切值 (z , 20℃, 120Hz±20%) 阶段 2: 冷却 2 小时后测试阻抗 (z , -55℃, 100kHz±10%)	阶段	温度	时间	1	20±2℃	30min	2	-55+0/-3℃	120min	3	(15℃~35℃)±2℃	15min	4	105+3/-0℃	120min	5	20±2℃	120min	阶段 2: 阻抗比率在 0.75 至 1.25 之间 阶段 5: 容量变化应在初值的±5% 范围内 损失角正切值小于或等于 1.5 倍标准值。 Step2:Impedance ratio(Zr/Zr0)within0.75to1.25 Step5:Variation of capacitance Within±5% of the value at Step 1. Dissipation Factor ≤ 150%of the specified value
阶段	温度	时间																			
1	20±2℃	30min																			
2	-55+0/-3℃	120min																			
3	(15℃~35℃)±2℃	15min																			
4	105+3/-0℃	120min																			
5	20±2℃	120min																			

		<p>阶段 3: 冷却 2 小时后测是容量和漏电流 阶段 4: 测试容量和损失角正切值 Step 1: Measure the capacitance and Dissipation Factor (z 20°C 120Hz±20%) Step 2: Measure the impedance thermal balance after 2 hours. (z , -55°C, 100kHz±10%) Step 3: Measure the capacitance and leakage current at thermal balance after 2 hours Step 4: Measure the capacitance and Dissipation Factor</p>																															
5.1.6	耐浪涌电压 Surge Test	<p>充电 30±5 秒，放电 5.5±0.5 分钟作为一个周期，共进行 1000 次。 测试温度：15°C-35°C 然后在标准大气条件下放置达到热稳定，测试各参数 1000 times of charging for 30±5 sec., with a period of 5.5±0.5 min.. Test temperature: 15°C-35°C And the capacitors shall be stored under standard atmospheric conditions to obtain thermal stability, after which measurements shall be made. 测试回路 Test circuit</p> <div style="text-align: center;"> </div> <p>instantaneous over voltage which may be applied to terminals of capacitors, therefore, not applicable to such over voltages as often applied.</p> <p>浪涌电压设定</p> <table border="1" style="margin-left: auto; margin-right: auto;"> <tr><td>RV(V)</td><td>6.3</td><td>7.5</td><td>10</td><td>12</td></tr> <tr><td>S.V(V)</td><td>7.2</td><td>8.6</td><td>11.5</td><td>13.8</td></tr> <tr><td>RV(V)</td><td>16</td><td>25</td><td>35</td><td>50</td></tr> <tr><td>S.V(V)</td><td>18.4</td><td>28.8</td><td>41</td><td>58</td></tr> <tr><td>RV(V)</td><td>63</td><td>80</td><td>100</td><td></td></tr> <tr><td>S.V(V)</td><td>73</td><td>92</td><td>115</td><td></td></tr> </table>	RV(V)	6.3	7.5	10	12	S.V(V)	7.2	8.6	11.5	13.8	RV(V)	16	25	35	50	S.V(V)	18.4	28.8	41	58	RV(V)	63	80	100		S.V(V)	73	92	115		<p>容量变化：在初始值的±20%以内 损耗角正切值：≦规定值的 150% 阻抗：≦规定值的 150% 漏电流：≦规定值</p> <p>Variation of capacitance: With ±20% of the initial value Dissipation factor: ≦ 150% of the specified value ESR: ≦ 150% of the specified value Leakage current: ≦ specified value</p>
RV(V)	6.3	7.5	10	12																													
S.V(V)	7.2	8.6	11.5	13.8																													
RV(V)	16	25	35	50																													
S.V(V)	18.4	28.8	41	58																													
RV(V)	63	80	100																														
S.V(V)	73	92	115																														

上海永铭电子股份有限公司 Shanghai Yongming Electronic Co.,Ltd.	铝电解电容器承认书 Aluminum Electrolytic Capacitors Specification	商标 
---	--	--

5.2 机械特性 MECHANICAL PERFORMANCE

序号 NO	项目 Item	测试方法 Test method	特性 Performance
5.2.1	振动试验 Resistance to Vibration	依据 JIS C 5102 8.2 和 JIS C 5025 试验。 在 3 个互相垂直的方向分别施加 2 小时振动， 共 6 小时 To comply with JIS C 5102 8.2 and JIS C 5025 Direction and duration of vibration: 3 orthogonal directions mutually each for 2 hours, total 6 hours.	测量电容器应无接触不良开路 或短路，无可见机械损伤。 When the capacitors is measured there shall be no intermittent contacts, or open or short circuiting There shall be no such mechanical damage.
5.2.2	可焊性 Solder ability	焊锡温度: 245±5℃ 浸入时间: 2.0±0.5 秒 Temperature or solder: 245±5℃ Dipping time: 2±0.5sec.	浸入焊锡的引线表面积约 95% 以上应附着新锡 At least 95% of circumferential surface of the dipping portion of termination shall be covered with new solder.

5.3 耐久性测试 ENDURANCE PERFORMANCE

序号 NO	项目 Item	测试方法 Test method	特性 Performance
5.3.1	耐焊接热 Resistance to soldering heat	焊槽法: 焊锡温度: 260±5℃ 浸入时间: 10±1 秒 电路板 : 1.0mm Solder bath method Solder temperature : 260±5℃ Immersion time : 10±1sec. Printed wiring board: 1.0mm	容量变化:在初始值的 ±5% 以内 损耗角正切值: ≤规定值的 130% 阻抗: ≤规定值的 130% 漏电流: ≤规定值 Variation of capacitance: With ±5% of the initial value Dissipation factor: ≤130% of the specified value ESR: ≤130% of the specified value Leakage current: ≤ specified value
5.3.2	稳态湿热 Resistance to damp heat (steady state)	试验温度: 60±2℃ 试验时间: 1000±8h 相对湿度: 90~95% 试验后, 电容器在标准大气条件下 1~2 小时, 然 后测试参数 Test temperature : 60±2℃ Test time : 1000±8h Relative humidity: 90~95% After completion of test, the capacitors shall be	容量变化:在初始值的 ±20% 以内 损耗角正切值: ≤规定值的 150% 阻抗: ≤规定值的 150% 漏电流: ≤规定值 Variation of capacitance: With ±20% of the initial value Dissipation factor: ≤150% of the specified value ESR: ≤150% of the specified value

名称 Name	承认书 Specification		承认书 Specification	页数 Page	6
版本 Version	03	标准指南 Standard manual	页数 Page	6	

		subjected to standard atmospheric conditions for 1 to 2 hours, after which measurements shall be made.	Leakage current: \leq specified value
5.3.3	高温负荷试验 Load life test	试验温度: $105 \pm 2^\circ\text{C}$, 施加额定电压和额定纹波电流 Application of the rated voltage and the rated ripple current, Test temperature: $105 \pm 2^\circ\text{C}$ 备注: 符荷寿命 2000H Note: load life 2000 h	容量变化: 在初始值的 $\pm 20\%$ 以内 损耗角正切值: \leq 规定值的 150% 阻抗: \leq 规定值的 150% 漏电流: \leq 规定值 Variation of capacitance: With $\pm 20\%$ of the initial value Dissipation factor: $\leq 150\%$ of the specified value ESR: $\leq 150\%$ of the specified value Leakage current: \leq specified value
5.3.4	快速变温 Rapid change of temperature	 <p style="text-align: center;"> 使用电压: 无符荷 Applied voltage: without load 循环次数: 5 次 Cycle number :5 Cycle </p>	容量变化: 在初始值的 $\pm 10\%$ 以内 损耗角正切值: \leq 规定值 漏电流: \leq 规定值 Variation of capacitance: With $\pm 20\%$ of the initial value Dissipation factor: ≤ 1 specified value Leakage current: \leq specified value

Table 2 :

阻抗 Impedance at 100kHz at $-55 \pm 3^\circ\text{C}$ or $105 \pm 2^\circ\text{C}$

阻抗比 Impedance ratio(120HZ)	
$Z(105^\circ\text{C})/Z(+20^\circ\text{C})$	≤ 1.25
$Z(-55^\circ\text{C})/Z(+20^\circ\text{C})$	≤ 1.25

6. 标记 MARKING

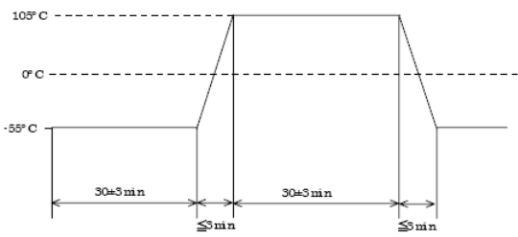
6. 1 在电容器体上注明有如下内容:

- | | |
|------------|--------------|
| 6.1.1 静电容量 | 6.1.2 额定工作电压 |
| 6.1.3 型号规格 | 6.1.4 负极标志 |
| 6.1.5 生产周期 | |

产品负极 →



6. 2 针对电容器体上信息举例说明:

上海永铭电子股份有限公司 Shanghai Yongming Electronic Co.,Ltd.	铝电解电容器承认书 Aluminum Electrolytic Capacitors Specification	商标 
---	--	--

3.2.1 180 代表静电容量;

3.2.1 180 represents electrostatic capacity

3.2.2 25V 代表产品额定工作电压;

3.2.2 25V represents the rated working voltage of the product

3.2.3 HT 代表产品系列, 其中产品系列与对应表示字母列出如下:

系列	VP1	VPX	VPT	VPL	VPH	VPM	VPG	VPS	VGY	VHT
	NP1	NPX	NPT	NPL	NPH	NPM	NPG	NPS	NGY	NHT
代表字母	P1	PX	PT	PL	PH	PM	PG	PS	GY	HT

3.2.4 G 代表产品生产年月, 其中产品生产年月与对应表示字母列出如下:

生产年份	2013	2014	2015	2016	2017	2018	201	202	2021	2022	...	2038
代表字母	A	B	C	D	E	F	G	H	J	K	...	Z

2.3.5 A 代表产品生产月份, 其中产品生产年份与对应表示字母列出如下

生产月份	1	2	3	4	5	6	7	8	9	10	11	12
代表字母	A	B	C	D	E	F	G	H	J	K	L	M

纹波电流补偿系数 Ripple Current Correction Factor

频率 (Hz) Frequency (Hz)	120	1K	10K	100K
修正因子 Correction Factor	0.1	0.45	0.5	1.0

8. 包装 PACKING







8.1 包装标签 PACKING LABEL

内标签样本 inner label sample

外箱标签样本 outer label sample

名称 Name	承认书 Specification	
版本 Version	03	页数 Page
标准指南 Standard manual		8

上海永铭电子股份有限公司 Shanghai Yongming Electronic Co.,Ltd.	铝电解电容器承认书 Aluminum Electrolytic Capacitors Specification	商标 
---	--	--

 Certification 合格证		 上海永铭电子股份有限公司 SHANGHAI YONGMING ELECTRONIC CO.,LTD	
Product name: VKM_250V_4.7μF_6.3*10_-20%+20%_透明胶管 产品名称	Product name: VKM_250V_4.7μF_6.3*10_-20%+20%_透明胶管		
LOT NO: YM170504659-4 生产批号	QTY: 4200 数量	PCS: 4200 数量	数量/QTY: 12600 PCS
Production date: 2017-06-07 生产日期	Product NO: 620849 产品编号	Lot No: SC0370060717 批号/LOT NO	Net Weight: KG 净重/NW
Customer Item Code: 客户物料描述	Production date: 2017-6-7 生产日期/Production date		Gross Weight: KG 毛重/GW
		 QC:	

包装标签内容 Packing Label Marked (the following items shall be marked on the label)

(Inside box or bag,outer box)

- 1)产品名称 Product name
- 2)生产批号 Lot No
- 3)数量 quantity
- 4)生产日期 Production date
- 5)产品编号 Part No
- 6)客户物料描述 Customer item code

8.2 批号 Lot number:

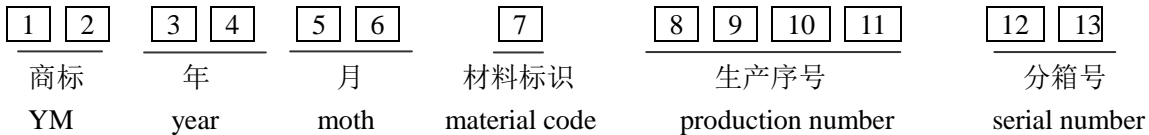

8.3 尺寸表 (单位 mm):

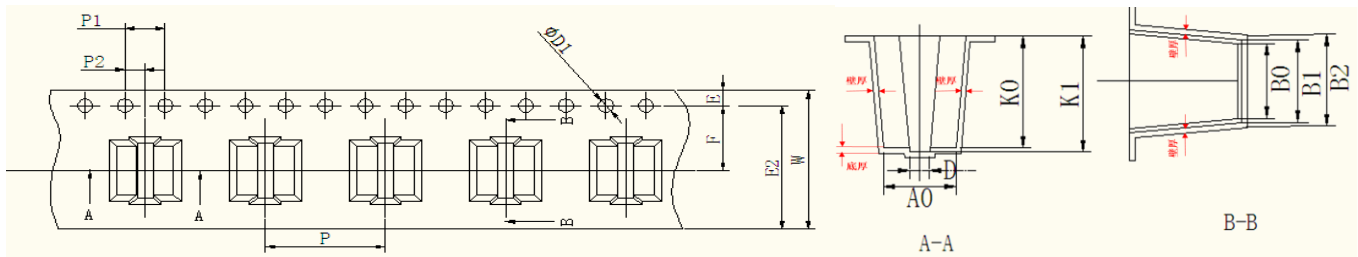

标准	W	A0	B0	B1	B2	D	D1	E	F	K0	K1	P	t
品名	+0.1 -0.3	±0.1	±0.1	±0.1	±0.2	±0.1	+0.1 -0.0	±0.1	±0.1	±0.1	±0.1	±0.1	±0.05
/	/	/	/	/	/	/	/	/	/	/	/	/	/

名称	Name	承认书		Specification
版本	Version	03	页数	Page
标准指南		Standard manual		

8.4 料盘和包装数量 Taping Reel and Packing Quantity :

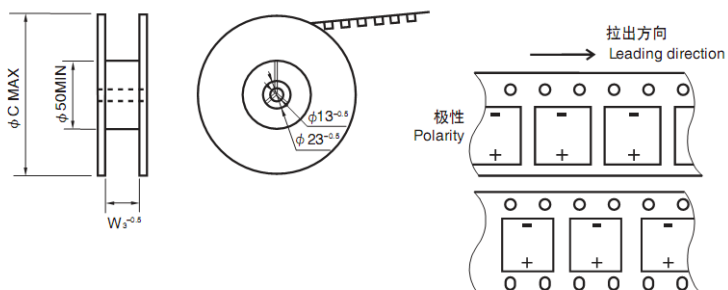

尺寸 Size	W3 (mm)	φC (mm)	每卷数量 pcs	内盒		外箱	
				料盘数 (卷)	每盒数量 pcs	内盒数量 (盒)	每箱数量 pcs
/	/	/	/	/	/	/	/

9. 产品编码规则

Product Code Rules

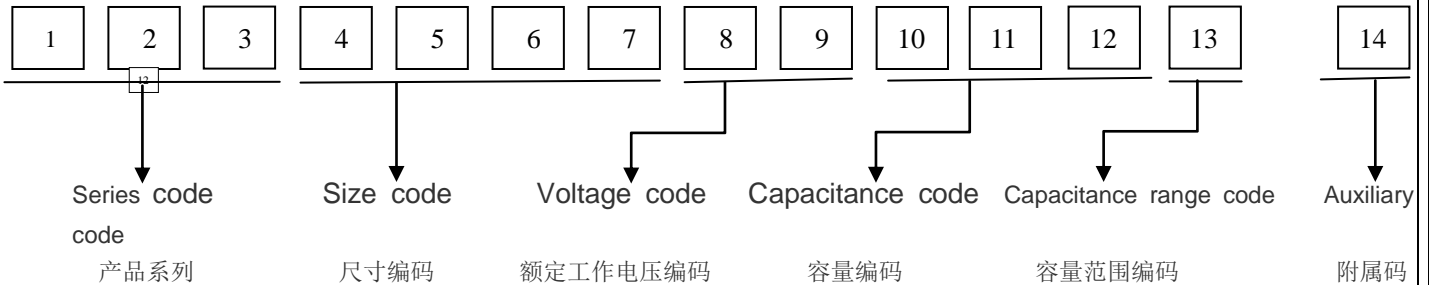

产品系列	
系列	编码
NP1	NP1
NPX	NPX
NPH	NPH
NPT	NPT
NPL	NPL
VP1	VP1
VPX	VPX
VPH	VPH
VPT	VPT
VPL	VPL

静电容量			
容量	编码	容量	编码
1.0 μF	1R0	180 μF	181
1.5 μF	1R5	220 μF	221
2.2 μF	2R2	270 μF	271
2.7 μF	2R7	330 μF	331
3.3 μF	3R3	390 μF	391
4.7 μF	4R7	470 μF	471
5.6 μF	5R6	560 μF	561
6.8 μF	6R8	680 μF	681
8.2 μF	8R2	820 μF	821
10 μF	100	1000 μF	102
12 μF	120	1200 μF	122
15 μF	150	1500 μF	152
18 μF	180	1800 μF	182
22 μF	220	2000 μF	202
27 μF	270	2200 μF	222
33 μF	330	2500 μF	252
39 μF	390	2700 μF	272
47 μF	470	3300 μF	332
56 μF	560	3900 μF	392
68 μF	680	4700 μF	472
82 μF	820	5600 μF	562
100 μF	101	6800 μF	682
120 μF	121	8200 μF	822
150 μF	151	10000 μF	103

产品直径	编码	产品高度	编码	产品高度	编码
3.5	F	3.55	035	15	150
4	A	3.95	039	16	160
4.5	G	4.5	045	16.5	165
5	B	5	050	17	170
5.5	H	5.4	054	18	180
6.3	C	5.8	058	19	190
8	D	6.5	065	20	200
10	E	7	070	21	210
12.5	L	7.7	077	22	220
16	I	8	080	23	230
18	J	8.5	085	25	250
20	N	9	090	28	280
22	K	9.5	095	30	300
25	M	10	100	31.5	315
30	P	10.5	105	32	320
35	Q	11	110	35.5	355
40	R	11.5	115	36	360
		12	120	40	400
		12.5	125	41.5	415
		13	130	45	450
		13.5	135	50	500
		14	140		
		14.5	145		

额定工作电压	
电压	编码
6.3V	0J
7.5V	0L
10V	1A
12V	1B
16V	1C
25V	1E
35V	1V
50V	1H
63V	1J
80V	1K
100V	2A
125V	2B
160V	2C
200V	2D
250V	2E

容量范围	
级别	编码
±20%	M

附属码	
V	固态 SMD

10、贴片电解使用时应满足以下条件：

Below requirement should be met when use SMD capcitors

无铅型回流焊允许条件 Lead free ty pe reflow soldering condition :

铝壳尺寸 $\phi 5 \sim \phi 10\text{mm}$ size $\phi 5 \sim \phi 10\text{mm}$

电容器表面温度在 $T^\circ\text{C}$ 以下； Temperature at surface of capacitor should below $T^\circ\text{C}$.

电容器表面温度在 200°C 以上的时间不能超过 t 秒。 $T_1^\circ\text{C}$ 以上的时间不可超过 t_1 ；

The time of the surface temperature of the capacitors above 200°C cannot exceed t second.

The time of the surface temperature of capacitors above $T_1^\circ\text{C}$ can not exceed t_1 .

预热控制在 $100^\circ\text{C} \sim 200^\circ\text{C}$ 180 秒以内。

Preheat should be made between $100^\circ\text{C} \sim 200^\circ\text{C}$ and for maximum 180 seconds.

系列名称 Series	产品尺寸 size	T ($^\circ\text{C}$) ①	T ₁ ($^\circ\text{C}$)	t (sec) ②	t ₁ (sec) ③	回流焊次数 Reflow cycle
VPX	$\Phi 10$	235	230	60	30	1

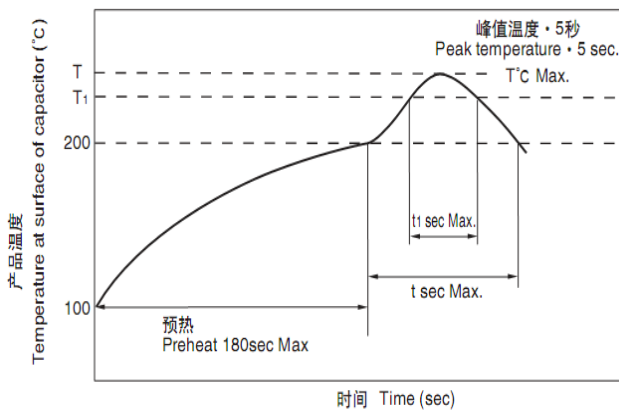

①峰值温度 peak temperature

②超过 200°C 的时间 (MAX)

Max time above 200°C

③超过 T_1 的时间为 (MAX)

Max time above T_1

出现超过允许条件的情况，请联系我们。

If other condition over maximum, please contact us.

带辅助端子的抗振结构产品

Vibration proof packages with the supporting terminal.

对于外壳尺寸在 $\phi 8$ 以上的贴切片型电容器，可带有抗振结构。

For chip Aluminum electrolytic capacitors more than can size ($\Phi 8$, vibration proof packages supports.

当出现错焊时请进行手动重焊。此时，请设定烙铁尖端温度为 $380 \pm 10^\circ\text{C}$ ，对电容器进行 3 ± 0.5 秒的焊接。

When there is mistake during soldering, please re-solder manually, the temperature of soldering iron should be set at $380 \pm 10^\circ\text{C}$, and the soldering time on capacitor is 3 ± 0.5 seconds.

上海永铭电子股份有限公司 Shanghai Yongming Electronic Co.,Ltd.	铝电解电容器承认书 Aluminum Electrolytic Capacitors Specification	商标 
---	--	--

11. 其他 The others

11.1 铝电解电容器的应用上的重要信息

Important information on the application of aluminum electrolytic capacitors

12.1.1. 电解电容是有极性的 DC electrolytic capacitors are polarized

当施加反向直流电压时，电容器将变为短路，电路中使用没有极化电容会被损坏，因为可施加到正电压的阴极端子的电路中流过异常电流。 When reverse voltage is applied on DC electrolytic capacitors, the capacitors will becomes short-circuited please use no polarized capacitors in the circuit be damage due to abnormal current flows through the capacitors since the circuit where the positive voltage may be applied to the cathode terminal.

11.1.2. 使用电容器额定电压 Use capacitors within rated voltage

当电容器用比额定电压更高的电压时，漏电流增加，特性显著恶化，并在很短的时间内发生损坏的结果。请特别小心的峰值电压不应超过额定电压。 When capacitors is used at higher voltage than the rated voltage, leakage current increases, characteristics drastically deteriorate and damage in a short period may occur as a result. Please take extra caution that the peak voltage should not exceed the rated voltage.

11.1.3. 充电和放电应用 Charge and discharge application.

当铝电解电容器用于快速充电和放电的应用，其寿命可缩短减少，热量上升，等等。

When aluminum electrolytic capacitors for general purpose are employed in rapid charge and discharge application, its life expectancy may be shortened by capacitance decrease, heat rise, etc.

11.1.4. 存储电容器 Store the capacitors.

在已经存储了长时间的铝电容器其漏电流上升是常见的。存储温度越高，漏电流增大，因此，请采取预防措施，如存储位置。有电压被施加到电容器上时其漏电流逐渐减小。漏电流增加，会造成问题，因此，使用前在电路中施加电压（老化）。 Increased leakage current is common in aluminum capacitors which have been stored for long period of time. The Higher the storage temperature, the higher the leakage current increase, therefore please take precautions concerning the storage location. The leakage current decreases gradually as voltage are applied to the capacitor. In cases where increased leakage current causes problems in the circuit, apply voltage (aging) before using.

11.1.5 适用于电容器的纹波电流不应超过额定的值

Ripple current applied to capacitors should not exceed the rated value.

名称	Name	承认书 Specification		
版本	Version	03	页数 Page	13
标准指南 Standard manual				

上海永铭电子股份有限公司 Shanghai Yongming Electronic Co.,Ltd.	铝电解电容器承认书 Aluminum Electrolytic Capacitors Specification	商标 
---	--	--

如果纹波电流超过指定值，过多的热量会减少容量和缩短电容寿命。因此纹波电压的峰值应该小于额定电压。

Excessive heat will reduce capacitance and result in shortened life of capacitor if ripple currents exceeding the specified rated value are applied. The peak value of the ripple voltage should be less than the rated voltage.

11.1.6. 引线的强度 Intensity of lead

加到引线或端子，应力的内部连接。这可能会导致短路，开路或漏电流增加。在电容器已被焊接到PC板上后，弯曲或后处理电容器是不可取的。

When a strong force is applied to the lead wires or terminals, stress is put on the internal connections. This may result in short circuit, open circuit or increased leakage current. It is not

11.1.7 在焊接过程中的耐热性 Heat resistance at the soldering process

在PC板上安装铝电解电容器的浸焊工艺中，观察到PET外套二次收缩或开裂时，焊料的温度太高或浸渍时间太长。advisable to bend or handle a capacitors after it has been soldered to the PC board.

In the dip soldering process of PC board with aluminum electrolytic capacitors mounted, secondary shrinkage or crack of PET sleeve may be observed when solder temperature is too high or dipping time is too long.

11.1.8. PC板的孔间距和位置 Hole pitch and position of PC board.

设计印刷电路板，其孔距适合指定的目录或规格的电容的引线间距（铅的间距）。当电容器强行插入一个孔间距时，把应力加在引线。这可能会导致短路或漏电流增加。

capacitor specified by the catalog or specifications. When a capacitor is forcibly inserted into an unmatched hole A PC board must be designed so its hole pitch coincides with the lead pitch (lead spacing) of the pitch, a stress is put on the leads. This could result in a short circuit or increased leakage current.

11.2 该产品是无铅和环保 This product is lead free and environmental friendly. (SHAEC1900930702, SGS)

产品按照 ROHS 的标准，六种有害物质最大不超过下列要求： This products according to the standard of ROHS, it means the max capacitance Of six harmful material not over the following request:

Cd -100PPM	Pb -1000PPM	Hg -1000PPM
Cr+-1000PPM	PBBs -1000PPM	PBDEs -1000PPM

名称	Name	承认书 Specification		
版本	Version	03	页数	Page 14
标准指南		Standard manual		