



文件名称 <b>DOCUMENT NAME:</b> PRODUCT SPECIFICATION	主 题 SUBJECT: 2.8X1.9 TACT SWITCH 1TS028A-1800-0600	文件编号 DOCUMENT NO.: EB1-AS1C-177			
		PAGE	1 OF 13	REV.	A

\*\*\*\*\* 目 录 \*\*\*\*\*

项 目 Item	内 容 Description	页 次 Page
	目录 Content	1
	修订履历 Revision History	2
1	通则 General Characteristics	3
1.1	应用范围 Application range	3
1.2	使用环境条件 Acclimatization	3
1.3	测试条件 Test Conditions	3
2	外观和安装尺寸	3
2.1	外观 Appearance	3
2.2	安装尺寸 Mounting dimensions	3
3	驱动方式 Operate Mode	3
4	回路方式 Circuit Mode	3
5	额定负荷及寿命 Rating and Operating life	3
6	电气性能 Electrical Characteristics	4
7	机械性能 Mechanical Characteristics	6
8	耐久性试验 Durability Characteristics	9
9	耐侯试验 Weather Proof Characteristics	9
10	保护结构 Protection	11
11	焊接性能 Solder-ability requirement	12

	APPROVED	CHECKED	PREPARED	ISSUED BY:
BY	ZO	M.H.Li	Y.Y.Chen	
DATE	2019.7.30	2019.7.30	2019.7.30	





文件名称 <b>DOCUMENT NAME:</b> PRODUCT SPECIFICATION	主 题 SUBJECT: 2.8X1.9 TACT SWITCH 1TS028A-1800-0600	文件编号 DOCUMENT NO.: EB1-AS1C-177	PAGE	3 OF 13	REV.	A
--------------------------------------------------------	----------------------------------------------------------	------------------------------------	------	---------	------	---

## 1. 通则 General Characteristics

### 1.1 应用范围 Application range:

此产品规格书适用于轻触开关 1TS028A-1800-0600。

This product specification is applied to the 1TS028A-1800-0600 push-on type tact switch.

### 1.2 使用环境条件 Acclimatization:

使用温度范围 Operating Temperature range: -40℃~85℃

保存温度范围 Preservative Temperature range: -40℃~85℃

### 1.3 测试条件 Test Conditions:

若没有特别说明,则试验条件如下:

Unless otherwise specified, the atmospheric conditions for making measurements and tests are as follows:

温度 Temperature: 5~35℃

相对湿度 Relative Humidity:25~85%

气压 Air pressure:86~106Kpa

如对判定产生疑义, 则试验按以下条件进行:

However, if doubt arises on the decision based on the measured values under the above mentioned conditions, the following conditions shall be employed:

温度 Temperature:20±2℃

相对湿度 Relative Humidity:65±5%

气压 Air pressure:86~106Kpa

## 2. 外观和安装尺寸 Appearance & Mounting Dimensions:

### 2.1 外观 Appearance:

产品外观良好,无破损、锈蚀、裂纹和镀层缺陷。

The switch shall have good finishing, and no rust, crack or plating defects.

### 2.2 安装尺寸 Mounting dimensions:

应符合产品外形图 1TS028A 的要求。

Refer to product appearance drawing No.:1TS028A.

## 3. 驱动方式 Operate Mode:

按钮式 Push-on types.

## 4. 回路方式 Circuit Mode:

如成品图 1TS028A 所示(as assembly drawing 1TS028A).

## 5. 额定负荷及寿命 Rating and Operating life.

额定负载 Rating: DC 1V, 10 μA (min.)

额定负载 Rating: DC 12V, 50mA (max.)

负荷寿命 Operate Life With Load: 300,000cycles.



文件名称 <b>DOCUMENT NAME:</b> PRODUCT SPECIFICATION	主 题 SUBJECT: 2.8X1.9 TACT SWITCH 1TS028A-1800-0600	文件编号 DOCUMENT NO.: EB1-AS1C-177	PAGE	4 OF 13	REV.	A
--------------------------------------------------------	----------------------------------------------------------	------------------------------------	------	---------	------	---

## 6. 电气性能 Electrical Characteristics

### 6.1 外观检查 Visual Examination

测试条件 Test Method/Condition	标准 Criteria
产品未受力的情况下进行外观检查。 By Visual Examination choke without any out Pressure & testing.	产品无明显缺陷,不影响使用 There shall be no defects that affect the serviceability of the product. Visual inspection samples shall be free from defect such as damage, deformation, blister and burrs that are detrimental to the function and appearance.

### 6.2 镀层结合力测试

测试条件 Test Method/Condition	标准 Criteria
胶带测试法: 用钢刀划出不少于 3 条平行线, 然后用粘结强度不小于 45g/mm 的 3M 胶带拉表面镀层 (内部弹片和焊脚都需要测试)。 By Visual Examination choke without any out Pressure & testing.	在40倍显微镜下镀层无起皮、起泡、裂纹、脱落现象。 There shall be no defects that affect the serviceability of the product.

### 6.3 接触电阻 Contact Resistance

测试条件 Test Method/Condition	标准 Criteria
开关在无电气负荷状态下, 动作 3 次以上后, 用接触电阻测试仪器测量各接点的接触电阻。 Switch without load, operate more than 3 times, use contact resistance testing apparatus to test the contact resistance of each point of contact.	常态 Normal 500mΩ max 气候及寿命试验后 after weather and life proof: 1000 mΩ max

### 6.4 绝缘电阻 Insulation resistance

测试条件 Test Method/Condition	标准 Criteria
在相互绝缘的端子之间加载 100VDC , 持续时间 60 ±5 S。 100VDC Voltage is applied between terminals frame for 60 ±5S.	100MΩ min.



文件名称 <b>DOCUMENT NAME:</b> PRODUCT SPECIFICATION	主 题 SUBJECT: 2.8X1.9 TACT SWITCH 1TS028A-1800-0600	文件编号 DOCUMENT NO.: EB1-AS1C-177	PAGE	5 OF 13	REV.	A
--------------------------------------------------------	----------------------------------------------------------	------------------------------------	------	---------	------	---

### 6.5 抗电强度 Dielectric strength

测试条件 Test Method/Condition	标准 Criteria
<p>在相互绝缘的所有接线端子之间加载 250VAC (泄漏电流应不超过 0.5mA )的交流电,持续时间 <math>60 \pm 5</math> S。</p> <p>250VAC (leak current 0.5mA max ) alternate current load is applied between open terminals connected with wires, for <math>60 \pm 5</math>S.</p>	<p>无击穿和飞弧现象, 无绝缘破坏。</p> <p>No dielectric breakdown shall occur, no insulation destruction.</p>

### 6.6 弹跳 Bounce

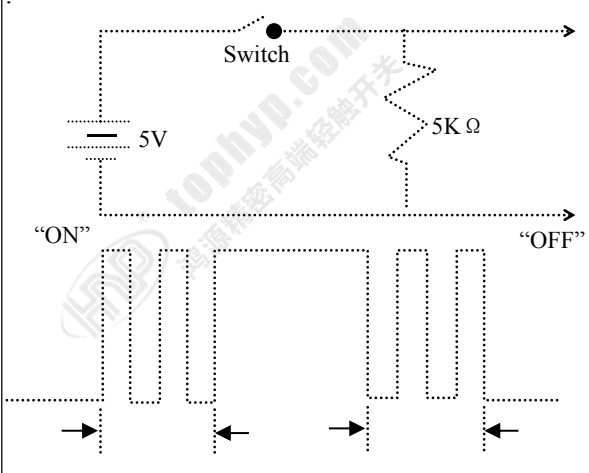
测试条件 Test Method/Condition	标准 Criteria
<p>使用规格书上2倍按压力来按压开关, 每秒按压3-4次。记录开关导通和断开过程的时间<math>t_{s1}</math>和<math>t_{s2}</math>。</p> <p>Press the center of operating part at the speed of 3-4 times per second, and measure bounce at ON and OFF.</p> 	<p>初态(initial): 10ms max.</p> <p>测试后 (包括环境和机械测试): 20ms max.</p>



文件名称 <b>DOCUMENT NAME:</b> PRODUCT SPECIFICATION	主 题 SUBJECT: 2.8X1.9 TACT SWITCH 1TS028A-1800-0600	文件编号 DOCUMENT NO.: EB1-AS1C-177	PAGE 6 OF 13	REV. A
--------------------------------------------------------	----------------------------------------------------------	------------------------------------	--------------	--------

## 7. 机械性能 Mechanical Characteristics

### 7.1 操作力、回弹力&手感 Push force 、 Return force& Click ratio

测试条件 Test Method/Condition	标准 Criteria	
两倍的作动力按压switch中心，速度12.5mm/min Double operating force by vertically pressing down the center of push button gradually until it stops. moving speed at 12.5mm/min	FP (Push force)	炉前：180±30gf 炉后：200±30gf
两倍的作动力按压switch中心，速度12.5mm/min Double operating force by vertically pressing down the center of push button gradually until it stops. moving speed at 12.5mm/min	FR (Return force)	30gf min.
参考下面曲线图。 Refer to the nether graph. Click ratio = $(F1-F2)/F1 \times 100\%$	CR (Click ratio)	炉前：40% min. 三次回流焊后：40% min.

### 7.2 行程 Travels

测试条件 Test Method/Condition	标准 Criteria
两倍的作动力按压switch中心，速度12.5mm/min Double operating force by vertically pressing down the center of push button gradually until it stops. moving speed at 12.5mm/min	0.13±0.05mm



文件名称 <b>DOCUMENT NAME:</b> PRODUCT SPECIFICATION	主 题 SUBJECT: 2.8X1.9 TACT SWITCH 1TS028A-1800-0600	文件编号 DOCUMENT NO.: EB1-AS1C-177	PAGE	7 OF 13	REV.	A
--------------------------------------------------------	----------------------------------------------------------	------------------------------------	------	---------	------	---

### 7.3 正向静压测试 Stopper strength

测试条件 Test Method/Condition	标准 Criteria
对产品施加5kgf按压力保持15秒。 Double operating force by vertically pressing down the center of push button	无机械和电气损伤。符合第 6.3 - 6.6 项和第 7.1 - 7.2 项要求。 The switch shall be free from abnormalities in electric and mechanism. According to item 6.3 - 6.6 and item 7.1-7.2 to examine.

### 7.4 振动 Vibration Proof

测试条件 Test Method/Condition	标准 Criteria
开关采用常规安装方法牢固地安装在试验设备上，按下述参数进行试验： 1) 振频:10~55HZ 2) 振幅:1.52 mm 3) 振动变化速率:10~55~10HZ 大约 1 分钟 4) 变频方法:对数或线形方式 5) 振动方向:三个互相垂直的方向，其中一个方向为操作元件运动的方向 6) 时间: 每个方向 2 小时 (共 6 小时)。 Switch shall be secured to a testing machine by a normal mounting device and method, Switch shall be measured after following test: 1)Vibration frequency range:10~5HZ 2)Total amplitude:1.5mm 3) Sweep ratio:10~55~10Hz,Approx 1 minute 4) Method of changing the sweep vibration frequency : logarithmic or linear 5) Direction of vibration : Three perpendicular directions including actuating direction. 6) Duration : 2 hours(6hours in total)	无机械和电气损伤。符合第 6.3 - 6.6 项和第 7.1 - 7.2 项要求。 The switch shall be free from abnormalities in electric and mechanism. According to item 6.3 - 6.6 and item 7.1-7.2 to examine.



文件名称 <b>DOCUMENT NAME:</b> PRODUCT SPECIFICATION	主 题 SUBJECT: 2.8X1.9 TACT SWITCH 1TS028A-1800-0600	文件编号 DOCUMENT NO.: EB1-AS1C-177	PAGE 8 OF 13	REV. A
--------------------------------------------------------	----------------------------------------------------------	------------------------------------	--------------	--------

### 7.5 冲击 Impact shock test

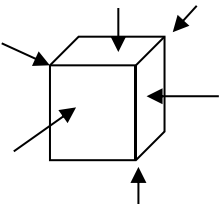
测试条件 Test Method/Condition	标准 Criteria
1) 加速度 Acceleration: 490m/S <sup>2</sup> 2) 作用时间:6ms 3) 冲击次数: 六个方向 3 次, 共 18 次  1) Acceleration: 490m/S <sup>2</sup> 2) Acting time:6ms 3) Cycle of test: 3 cycles each in 6 directions, for a total 18 cycles.  	无机械和电气损伤。符合第 6.3 – 6.6 项和第 7.1 – 7.2 项要求。  The switch shall be free from abnormalities in electric and mechanism. According to item 6.3 - 6.6 and item 7.1-7.2 to examine.

### 7.6 Top switch触点侧向推力强度测试 Side pressure strength of actuator

测试条件 Test Method/Condition	标准 Criteria
对触点x/y四个方向施加外力, 推力不小于500gf, 速度12.5mm/min。 Plunger push to side surface of actuator at horizontal direction as plunger Push force:500gf min moving speed at 12.5mm/min	Top Switch 四个方向推力不小于5N, 开关触头无脱落或变形; 开关触点和膜不偏位, 无破损开裂。 机械和电气性能满足规格要求 (符合第6.3 – 6.6 项和第7.1 – 7.2项要求) four directions(X/Y) of Actuator Push force:5N min No mechanical damage to component. Electrical and mechanical meet the specification requirements. ( item 6.3 - 6.6 and item 7.1-7.2 )





文件名称 <b>DOCUMENT NAME:</b> PRODUCT SPECIFICATION	主 题 SUBJECT: 2.8X1.9 TACT SWITCH 1TS028A-1800-0600	文件编号 DOCUMENT NO.: EB1-AS1C-177		
		PAGE	9 OF 13	REV. A

## 8 耐久性试验 Durability Characteristics

### 8.1 寿命试验 Operating Life

测试条件 Test Method/Condition	标准 Criteria
<p>在额定负荷的条件下，在寿命测试设备上连续转换 300,000 次，频率:120 次/分钟，操作力为:600±100gf。 300,000 cycles of operation shall be performed continuously with load at a rate of 120 cycles per minute, Push force: 600±100gf.</p>	<p>1) 动作力: 初始值的±30%。 Operating force : within ±30% initialization value.</p> <p>2) 无机械和电气损伤。符合第 6.3 - 6.6 项和第 7.1 - 7.2 项要求。 The switch shall be free from abnormalities in electric and mechanism. According to item 6.3 - 6.6 and item 7.1-7.2 to examine.</p>

## 9 耐候试验 Weather Proof Characteristics

### 9.1 耐低温 Resistance Low Temperature

测试条件 Test Method/Condition	标准 Criteria
<p>试件在-40±2℃的温控箱内保持 96 小时，然后在正常温度和湿度下恢复 1 小时，并在此后的 1 小时内对试件进行测量，水滴应消失。 After testing at -40±2℃ for 96 hours, the switch shall be allowed to stand under normal temperature and humidity conditions for 1 hour, and measurement shall be made with 1 hour after that, water drops shall be eliminated.</p>	<p>无机械和电气损伤。符合第 6.3 - 6.6 项和第 7.1 - 7.2 项要求。 The switch shall be free from abnormalities in electric and mechanism. According to item 6.3 - 6.6 and item 7.1-7.2 to examine.</p>



文件名称 <b>DOCUMENT NAME:</b> PRODUCT SPECIFICATION	主 题 SUBJECT: 2.8X1.9 TACT SWITCH 1TS028A-1800-0600	文件编号 DOCUMENT NO.: EB1-AS1C-177	PAGE	10 OF13	REV.	A
--------------------------------------------------------	----------------------------------------------------------	------------------------------------	------	---------	------	---

### 9.2 耐热性 Heat Resistance

测试条件 Test Method/Condition	标准 Criteria
<p>试件在 85±2℃ 的温控箱内保持 96 小时，然后在正常温度和湿度下恢复 1 小时，并在此后的 1 小时内对试件进行测量，水滴应消失。</p> <p>After testing at 85±2℃ for 96 hours the switch shall be allowed to stand under normal temperature and humidity conditions for 1 hour and measurement shall be made with 1 hour after that, water drops shall be eliminated.</p>	<p>无机械和电气损伤。符合第 6.3 - 6.6 项和第 7.1 - 7.2 项要求。</p> <p>The switch shall be free from abnormalities in electric and mechanism. According to item 6.3 - 6.6 and item 7.1-7.2 to examine.</p>

### 9.3 恒定湿热 Humidity Resistance

测试条件 Test Method/Condition	标准 Criteria
<p>试件在 60±2℃, 90~95%RH 的温控箱内保持 96 小时，然后在正常温度和湿度下恢复 1 小时，并在此后的 1 小时内对试件进行测量，水滴应消失。</p> <p>After testing at 60±2℃,90~95%RH for 96 hours ,the switch shall be allowed to stand under normal temperature and humidity conditions for 1 hour, and measurement shall be made within 1 hour after that .Water drops shall be eliminated.</p>	<p>无机械和电气损伤。符合第 6.3 - 6.6 项和第 7.1 - 7.2 项要求。</p> <p>The switch shall be free from abnormalities in electric and mechanism. According to item 6.3 - 6.6 and item 7.1-7.2 to examine.</p>

### 9.4 盐雾 Salt spray

测试条件 Test Method/Condition	标准 Criteria
<p>1) 测试时间: 48小时</p> <p>2) 测试温度湿度: 35°±2°c, 湿度 95~98%</p> <p>3) Salt NaCl mist 5%</p> <p>测试后用水冲洗连接器，然后放在室温下静置16小时</p> <p>1) Time of test: 48 hour</p> <p>2) temp:35° ±2° c R/H 90-95%</p> <p>3) Salt NaCl mist 5%</p> <p>After test wash parts and return to room ambient for 16hours.</p>	<p>无机械和电气损伤。符合第 6.3 - 6.6 项和第 7.1 - 7.2 项要求。</p> <p>The switch shall be free from abnormalities in electric and mechanism. According to item 6.3 - 6.6 and item 7.1-7.2 to examine.</p>



文件名称 <b>DOCUMENT NAME:</b> PRODUCT SPECIFICATION	主 题 SUBJECT: 2.8X1.9 TACT SWITCH 1TS028A-1800-0600	文件编号 DOCUMENT NO.: EB1-AS1C-177	PAGE	11 OF 13	REV.	A
--------------------------------------------------------	----------------------------------------------------------	------------------------------------	------	----------	------	---

## 10 保护结构 Protection

### 10.1 防尘保护 Dust Protection

IP6X相当 IP6X equivalent

测试条件 Test Method/Condition	标准 Criteria
开关按下述参数条件进行试验: 1) 滑石粉量: 2 kg/m <sup>3</sup> 2) 测试时间: 8 h 3) 试验后, 试件外部粉尘应去除。 Switch shall be checked after following test: 1) Amount of talc: 2 kg/m <sup>3</sup> 2) Time of test: 8 h 3) Dusts shall be removed.	1) 开关内不能有粉尘浸入。 No penetration of dusts shall be found inside of switch. 2) 无机械和电气损伤。符合第 6.3 - 6.6 项和第 7.1 - 7.2 项要求。 The switch shall be free from abnormalities in electric and mechanism. According to item 6.3 - 6.6 and item 7.1-7.2 to examine.

### 10.2 防水保护 Water Protection

IPX8相当 IPX8 equivalent

测试条件 Test Method/Condition	标准 Criteria
开关按下述参数条件进行试验: 1) 浸泡深度: 1.5 m 2) 浸泡时间: 30 分钟 min 3) 试验后, 试件外部水滴应去除。 Switch shall be checked after following test: 1) Depth of immersion: 1.5 m 2) Duration of immersion : 30 minute min 3) Water drops shall be removed.	1) 开关内不能有明显的水渍浸入影响产品性能。 No outstanding penetration of water which effects the functionality. 2) 无机械和电气损伤。符合第 6.3 - 6.6 项和第 7.1 - 7.2 项要求。 The switch shall be free from abnormalities in electric and mechanism. According to item 6.3 - 6.6 and item 7.1-7.2 to examine.



文件名称 <b>DOCUMENT NAME:</b> PRODUCT SPECIFICATION	主 题 SUBJECT: 2.8X1.9 TACT SWITCH 1TS028A-1800-0600	文件编号 DOCUMENT NO.: EB1-AS1C-177
		PAGE 12 OF 13 REV. A

## 11 焊接性能 Solder-ability requirement

### 11.1 沾锡测试 Surface Mount Solder-ability Test

测试条件 Test Method/Condition	标准 Criteria
<p>用锡膏将开关安装在 PCB 上，回流过程 2 次，焊接温度参考如下 IR 图表。</p> <p>Mount the switch on PCB by solder paste, reflow process 2 times, refer to the nether Soldering Temperature IR chart.</p>	<p>除了端子的裁切面外，所有样品的焊脚沾锡面积至少95%。</p> <p>At least 95% of immersed area should be adequately wetted on all samples except on cutting edge of terminal.</p>

### 11.2 过炉测试 Resistance to Reflow Soldering Heat

测试条件 Test Method/Condition	标准 Criteria
<p>测试样品需过炉三次</p> <p>参考第11.1项炉温曲线，不带锡膏，不使用氮气。</p> <p>The unmated DUT should withstand three immediately followed reflow processes meet item 11.1 IR curve.</p> <p>Nitrogen is not allowed for this test.</p> <p>Number of reflows should meet at least 3 cycles.</p>	<p>产品功能ok</p> <p>电气性能ok</p> <p>产品过炉后无任何变形，尺寸仍需满足规格要求</p> <p>The functional and electrical requirements still fulfilled.</p> <p>No deformation of component after reflow on any side of the component.</p>



文件名称 <b>DOCUMENT NAME:</b> PRODUCT SPECIFICATION	主 题 SUBJECT: 2.8X1.9 TACT SWITCH 1TS028A-1800-0600	文件编号 DOCUMENT NO.: EB1-AS1C-177	PAGE	13 OF 13	REV.	A
--------------------------------------------------------	----------------------------------------------------------	------------------------------------	------	----------	------	---

### 11.3 爬锡&锡渗透 Flux resistance / penetration

测试条件 Test Method/Condition	标准 Criteria
测试样品需过炉三次 参考第11.1项炉温曲线。 The component should withstand three immediately followed item 11.1 IR curve.	不允许助焊剂和锡膏侵入到端子接触部位。 产品功能OK 电气性能ok No flux or solder ingress into contact area. The functional and electrical requirements fulfilled.

### 11.4 焊接强度Solder peel off strength

测试条件 Test Method/Condition	标准 Criteria
柱塞推到开关侧面（开关X/Y侧面） 移动速度为5毫米/分钟 推力：15N Plunger push to side surface of switch（X/Y side surface of switch） moving speed at 5mm/min	产品无机械损伤 电气性能满足规格要求。 1.Top Switch four directions(X/Y) Push force:15N min 2.Side switch F1 direction Push force:50N min 3.Side Switch other three direction :30N min No mechanical damage to component. Electrical performance still within requirements.

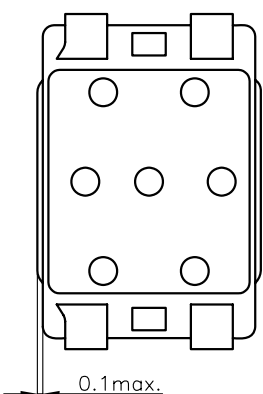
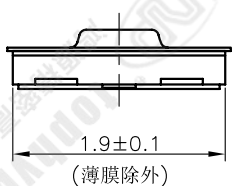
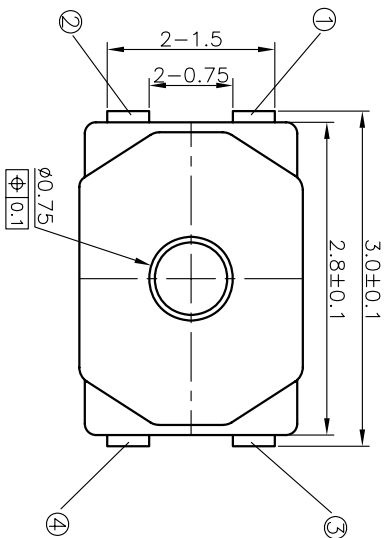

额定负荷 Rating	DC 12V/50mA
接触电阻 Contact Resistance	500mΩ max.
绝缘电阻 Insulation resistance	DC:100V 60S 100MΩ min. AC:250V(50-60HZ) 60S min.
抗电强度 Dielectric strength	AC:250V(50-60HZ) 60S min.
操作力 Operation force	≥100±30gf ≤190±30gf
寿命试验 Operating Life	300,000 cycles
行程 Travels	0.13±0.05mm

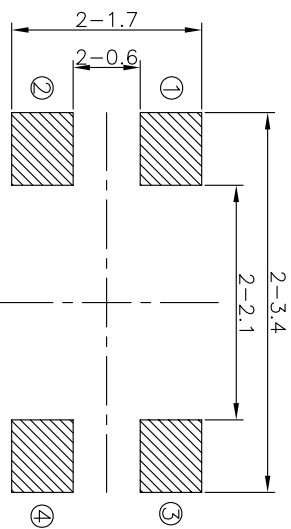
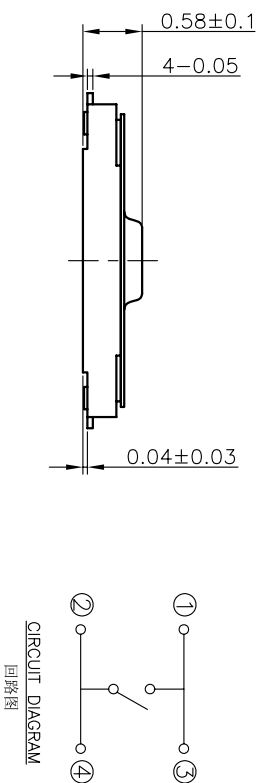

RECOMMENDED P.C.B. LAYOUT

安装尺寸图

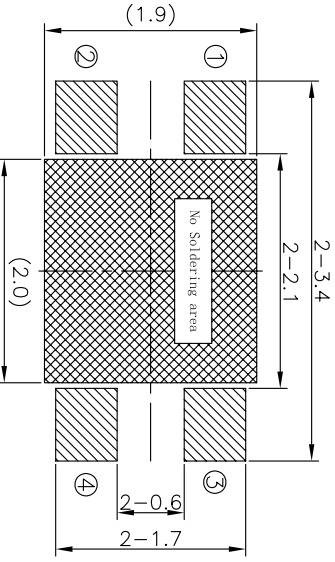

PRODUCT NO.: 1TS028A\*\*\*-060\*\*

- 轻触开关
- 2.8X1.9系列
- 外形: A=四脚 B=四脚无按柄
- 按点颜色: 底座颜色: 贴膜颜色:
- 操作力度: 100=100gf, 160=160gf, 225=225gf
- 手感: 0=常握(弹片), 1=大手感(弹片), 2=小手感(弹片), 3=特殊手感(弹片)
- 材质: 0=初始材质, 1=新增材质, 3=3个弹片依次增加
- 其它: CT=编带(非编带,不启用)

ITEM	PART NAME	QUANTITY	MATERIAL	FINISH
5	KNOB	1	POLYAMIDE	BLACK
4	FILM	1	POLYAMIDE	WHITE
3	DOME	2	SUS301	Ag-PLATED
2	HOUSING	1	POLYAMIDE	BLACK
1	TERMINAL	1	PHOSPHOR BRONZE	Ag-PLATED

X. ± 0.2	X' ± 0.2'	UNITS	MM
.X ± 0.1	X' ± 0.1'	MAT'L	
.XX ± 0.01	.XX' ± 0.01'	FINISH	
.XXX ± 0.002	.XXX' ± 0.002'		

NAME(INTENDED USE)	HON YUAN
2.8X1.9 SERIES	HON YUAN PRECISION IND. CO.,LTD.
TACT SWITCHES	SHENZHEN, CHINA.
PART NO.(INTENDED USE)	PRODUCT DRAWING
1TS028A***-060**	
APPD: ZO 1/9/2019	DWG NO.: 1TS028A
CHKD: M.H.LI 1/9/2019	
DR: WP.LU 1/9/2019	

THESE DRAWINGS AND SPECIFICATIONS ARE THE PROPERTY OF HON YUAN PRECISION IND. CO., LTD. AND SHALL NOT BE REPRODUCED, COPIED OR USED IN ANY MANNER WITHOUT THE PRIOR WRITTEN CONSENT OF HON YUAN PRECISION IND. CO., LTD.

SCALE SHEET	25/1
REV.	A