



## Data Sheet

## $\pi$ 160U/ $\pi$ 161U/ $\pi$ 162U/ $\pi$ 163U

### FEATURES

Ultra low power consumption (150Kbps):

0.55mA/Channel

High data rate:  $\pi$ 16xAxx: 600Mbps  
 $\pi$ 16xExx: 200Mbps  
 $\pi$ 16xMxx: 10Mbps  
 $\pi$ 16xUxx: 150kbps

High common-mode transient immunity: 150 kV/ $\mu$ s typical

High robustness to radiated and conducted noise

Isolation voltages:

$\pi$ 16xx3x: AC 3000Vrms

$\pi$ 16xx6x: AC 6000Vrms

High ESD rating:

ESDA/JEDEC JS-001-2017

Human body model (HBM)  $\pm$ 8kV, all pins

Safety and regulatory approvals (Pending):

UL certificate number: E494497

3000Vrms/6000Vrms for 1 minute per UL 1577

CSA Component Acceptance Notice 5A

VDE certificate number: 40047929

DIN V VDE V 0884-10 (VDE V 0884-10):2006-12

$V_{IORM} = 707V$  peak/1200V peak

CQC certification per GB4943.1-2011

3 V to 5.5 V level translation

AEC-Q100 qualification

Wide temperature range:  $-40^{\circ}C$  to  $125^{\circ}C$

16-lead, RoHS-compliant, (W)SOIC package

### APPLICATIONS

General-purpose multichannel isolation

Industrial field bus isolation

### GENERAL DESCRIPTION

The  $\pi$ 1xxxx is a 2PaiSemi digital isolators product family that includes over hundreds of digital isolator products. By using matured standard semiconductor CMOS technology and 2PaiSEMI *iDivider* technology, these isolation components provide outstanding performance characteristics and reliability superior to alternatives such as optocoupler devices and other integrated isolators.

Intelligent voltage divider technology (*iDivider* technology) is a new generation digital isolator technology invented by 2PaiSEMI. It uses the principle of capacitor voltage divider to transmit voltage signal directly cross the isolator capacitor without signal modulation and demodulation.

The  $\pi$ 1xxxx isolator data channels are independent and are available in a variety of configurations with a withstand voltage

rating of 1.5 kV rms to 6.0 kV rms and the data rate from DC up to 600Mbps (see the Ordering Guide). The devices operate with the supply voltage on either side ranging from 3.0 V to 5.5 V, providing compatibility with lower voltage systems as well as enabling voltage translation functionality across the isolation barrier. The fail-safe state is available in which the outputs transition to a preset state when the input power supply is not applied.

### FUNCTIONAL BLOCK DIAGRAMS

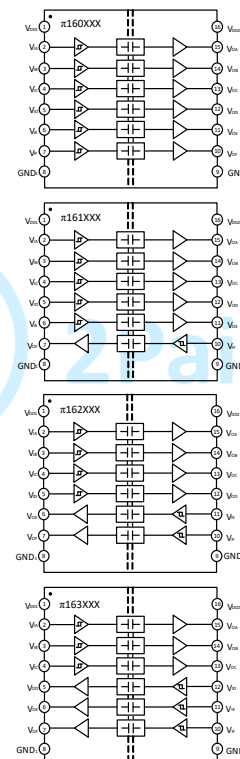

Figure1.  $\pi$ 160xxx/ $\pi$ 161xxx/ $\pi$ 162xxx/ $\pi$ 163xxx functional Block Diagram

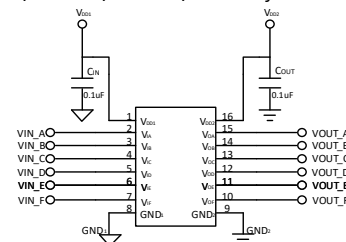

Figure2.  $\pi$ 160xxx Typical Application Circuit

## PIN CONFIGURATIONS AND FUNCTIONS

### $\pi$ 160Uxx Pin Function Descriptions

Pin No.	Name	Description
1	V <sub>DD1</sub>	Supply Voltage for Isolator Side 1.
2	V <sub>IA</sub>	Logic Input A.
3	V <sub>IB</sub>	Logic Input B.
4	V <sub>IC</sub>	Logic Input C.
5	V <sub>ID</sub>	Logic Input D.
6	V <sub>IE</sub>	Logic Input E.
7	V <sub>IF</sub>	Logic Input F.
8	GND <sub>1</sub>	Ground 1. This pin is the ground reference for Isolator Side 1.
9	GND <sub>2</sub>	Ground 2. This pin is the ground reference for Isolator Side 2.
10	V <sub>OF</sub>	Logic Output F.
11	V <sub>OE</sub>	Logic Output E.
12	V <sub>OD</sub>	Logic Output D.
13	V <sub>OC</sub>	Logic Output C.
14	V <sub>OB</sub>	Logic Output B.
15	V <sub>OA</sub>	Logic Output A.
16	V <sub>DD2</sub>	Supply Voltage for Isolator Side 2.

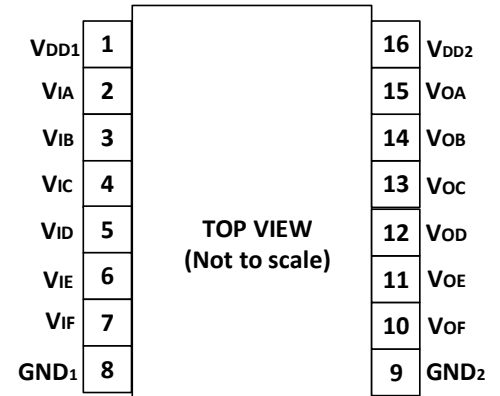

Figure3.  $\pi$ 160Uxx Pin Configuration

### $\pi$ 161Uxx Pin Function Descriptions

Pin No.	Name	Description
1	V <sub>DD1</sub>	Supply Voltage for Isolator Side 1.
2	V <sub>IA</sub>	Logic Input A.
3	V <sub>IB</sub>	Logic Input B.
4	V <sub>IC</sub>	Logic Input C.
5	V <sub>ID</sub>	Logic Input D.
6	V <sub>IE</sub>	Logic Input E.
7	V <sub>OF</sub>	Logic Output F.
8	GND <sub>1</sub>	Ground 1. This pin is the ground reference for Isolator Side 1.
9	GND <sub>2</sub>	Ground 2. This pin is the ground reference for Isolator Side 2.
10	V <sub>IF</sub>	Logic Input F.
11	V <sub>OE</sub>	Logic Output E.
12	V <sub>OD</sub>	Logic Output D.
13	V <sub>OC</sub>	Logic Output C.
14	V <sub>OB</sub>	Logic Output B.
15	V <sub>OA</sub>	Logic Output A.
16	V <sub>DD2</sub>	Supply Voltage for Isolator Side 2.

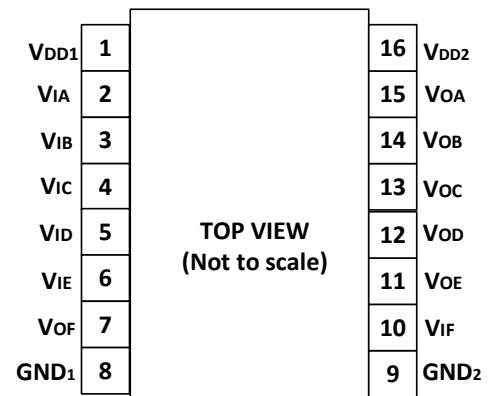

Figure4.  $\pi$ 161Uxx Pin Configuration

$\pi$ 162Uxx Pin Function Descriptions

Pin No.	Name	Description
1	V <sub>DD1</sub>	Supply Voltage for Isolator Side 1.
2	V <sub>IA</sub>	Logic Input A.
3	V <sub>IB</sub>	Logic Input B.
4	V <sub>IC</sub>	Logic Input C.
5	V <sub>ID</sub>	Logic Input D.
6	V <sub>OE</sub>	Logic Output E.
7	V <sub>OF</sub>	Logic Output F.
8	GND <sub>1</sub>	Ground 1. This pin is the ground reference for Isolator Side 1.
9	GND <sub>2</sub>	Ground 2. This pin is the ground reference for Isolator Side 2.
10	V <sub>IF</sub>	Logic Input F.
11	V <sub>IE</sub>	Logic Input E.
12	V <sub>OD</sub>	Logic Output D.
13	V <sub>OC</sub>	Logic Output C.
14	V <sub>OB</sub>	Logic Output B.
15	V <sub>OA</sub>	Logic Output A.
16	V <sub>DD2</sub>	Supply Voltage for Isolator Side 2.

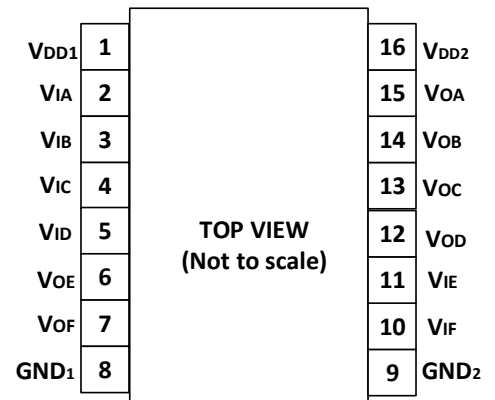

Figure5.  $\pi$ 162Uxx Pin Configuration

$\pi$ 163Uxx Pin Function Descriptions

Pin No.	Name	Description
1	V <sub>DD1</sub>	Supply Voltage for Isolator Side 1.
2	V <sub>IA</sub>	Logic Input A.
3	V <sub>IB</sub>	Logic Input B.
4	V <sub>IC</sub>	Logic Input C.
5	V <sub>OD</sub>	Logic Output D.
6	V <sub>OE</sub>	Logic Output E.
7	V <sub>OF</sub>	Logic Output F.
8	GND <sub>1</sub>	Ground 1. This pin is the ground reference for Isolator Side 1.
9	GND <sub>2</sub>	Ground 2. This pin is the ground reference for Isolator Side 2.
10	V <sub>IF</sub>	Logic Input F.
11	V <sub>IE</sub>	Logic Input E.
12	V <sub>ID</sub>	Logic Input D.
13	V <sub>OC</sub>	Logic Output C.
14	V <sub>OB</sub>	Logic Output B.
15	V <sub>OA</sub>	Logic Output A.
16	V <sub>DD2</sub>	Supply Voltage for Isolator Side 2.

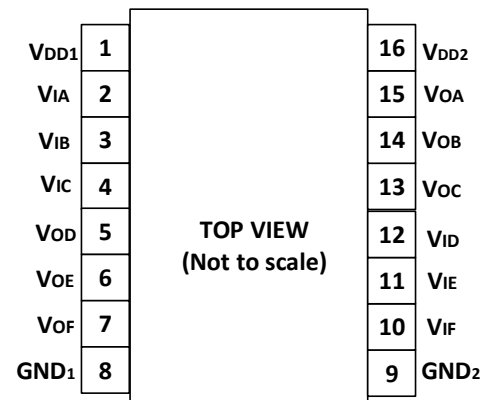

Figure6.  $\pi$ 163Uxx Pin Configuration

## ABSOLUTE MAXIMUM RATINGS

$T_A = 25^\circ\text{C}$ , unless otherwise noted.

**Table 1. Absolute Maximum Ratings<sup>4</sup>**

Parameter	Rating
Supply Voltages ( $V_{DD1-GND1}$ , $V_{DD2-GND2}$ )	-0.5 V to +7.0 V
Input Voltages ( $V_{IA}$ , $V_{IB}$ ) <sup>1</sup>	-0.5 V to $V_{DDx} + 0.5$ V
Output Voltages ( $V_{OA}$ , $V_{OB}$ ) <sup>1</sup>	-0.5 V to $V_{DDx} + 0.5$ V
Average Output Current per Pin <sup>2</sup> Side 1 Output Current ( $I_{O1}$ )	-10 mA to +10 mA
Average Output Current per Pin <sup>2</sup> Side 2 Output Current ( $I_{O2}$ )	-10 mA to +10 mA
Common-Mode Transients Immunity <sup>3</sup>	-150 kV/ $\mu\text{s}$ to +150 kV/ $\mu\text{s}$
Storage Temperature ( $T_{ST}$ ) Range	-65°C to +150°C
Ambient Operating Temperature ( $T_A$ ) Range	-40°C to +125°C

Notes:

<sup>1</sup>  $V_{DDx}$  is the side voltage power supply  $V_{DD}$ , where  $x = 1$  or  $2$ .

<sup>2</sup> See Figure7 for the maximum rated current values for various temperatures.

<sup>3</sup> See Figure21 for Common-mode transient immunity (CMTI) measurement.

<sup>4</sup> Stresses at or above those listed under Absolute Maximum Ratings may cause permanent damage to the device. These are stress rating only; functional operation of the device at these or any other conditions above those indicated in the operational section of this specification is not implied. Operation beyond the maximum operating conditions for extended periods may affect product reliability.

## RECOMMENDED OPERATING CONDITIONS

**Table 2. Recommended Operating Conditions**

Parameter	Symbol	Min	Typ	Max	Unit
Supply Voltage	$V_{DDx}$ <sup>1</sup>	3		5.5	V
High Level Input Signal Voltage	$V_{IH}$	$0.7 \cdot V_{DDx}$ <sup>1</sup>		$V_{DDx}$ <sup>1</sup>	V
Low Level Input Signal Voltage	$V_{IL}$	0		$0.3 \cdot V_{DDx}$ <sup>1</sup>	V
High Level Output Current	$I_{OH}$	-6			mA
Low Level Output Current	$I_{OL}$			6	mA
Maximum Data Rate		0		150	Kbps
Junction Temperature	$T_J$	-40		150	°C
Ambient Operating Temperature	$T_A$	-40		125	°C

Notes:

<sup>1</sup>  $V_{DDx}$  is the side voltage power supply  $V_{DD}$ , where  $x = 1$  or  $2$ .

## Truth Tables

**Table 3.  $\pi 160xxx/\pi 161xxx/\pi 162xxx/\pi 163xxx$  Truth Table**

$V_{ix}$ Input <sup>1</sup>	$V_{DD1}$ State <sup>1</sup>	$V_{DD0}$ State <sup>1</sup>	Default Low $V_{ox}$ Output <sup>1</sup>	Default High $V_{ox}$ Output <sup>1</sup>	Test Conditions /Comments
Low	Powered <sup>2</sup>	Powered <sup>2</sup>	Low	Low	Normal operation
High	Powered <sup>2</sup>	Powered <sup>2</sup>	High	High	Normal operation
Open	Powered <sup>2</sup>	Powered <sup>2</sup>	Low	High	Default output
Don't Care <sup>4</sup>	Unpowered <sup>3</sup>	Powered <sup>2</sup>	Low	High	Default output <sup>5</sup>
Don't Care <sup>4</sup>	Powered <sup>2</sup>	Unpowered <sup>3</sup>	High Impedance	High Impedance	

Notes:

<sup>1</sup>  $V_{ix}/V_{ox}$  are the input/output signals of a given channel (A or B).  $V_{DD1}/V_{DD0}$  are the supply voltages on the input/output signal sides of this given channel.

<sup>2</sup> Powered means  $V_{DDx} \geq 2.9V$

<sup>3</sup> Unpowered means  $V_{DDx} < 2.3V$

<sup>4</sup> Input signal ( $V_{ix}$ ) must be in a low state to avoid powering the given  $V_{DD1}$  through its ESD protection circuitry.

<sup>5</sup> If the  $V_{DD1}$  goes into unpowered status, the channel outputs the default logic signal after around 1 $\mu s$ . If the  $V_{DD1}$  goes into powered status, the channel outputs the input status logic signal after around 3 $\mu s$ .

## SPECIFICATIONS

### ELECTRICAL CHARACTERISTICS

**Table 4. Switching Specifications**

$V_{DD1} - V_{GND1} = V_{DD2} - V_{GND2} = 3.3V_{DC} \pm 10\%$  or  $5V_{DC} \pm 10\%$ ,  $T_A = 25^\circ C$ , unless otherwise noted.

Parameter	Symbol	Min	Typ	Max	Unit	Test Conditions/Comments
Minimum Pulse Width	PW			6.5	us	Within pulse width distortion (PWD) limit
Maximum Data Rate		150			Kbps	Within PWD limit
Propagation Delay Time <sup>1,4</sup>	$t_{pHL}, t_{pLH}$		3.0	4.5	us	The different time between 50% input signal to 50% output signal 50% @ 5V <sub>DC</sub> supply
			3.2	4.8	us	@ 3.3V <sub>DC</sub> supply
Pulse Width Distortion <sup>4</sup>	PWD	0	0.02	0.2	us	The max different time between $t_{pHL}$ and $t_{pLH}$ @ 5V <sub>DC</sub> supply. And The value is $ t_{pHL} - t_{pLH} $
		0	0.02	0.2	us	@ 3.3V <sub>DC</sub> supply
Part to Part Propagation Delay Skew <sup>4</sup>	$t_{PSK}$			0.3	us	The max different propagation delay time between any two devices at the same temperature, load and voltage @ 5V <sub>DC</sub> supply
				0.3	us	@ 3.3V <sub>DC</sub> supply
Channel to Channel Propagation Delay Skew <sup>4</sup>	$t_{CSK}$		0	0.2	us	The max amount propagation delay time differs between any two output channels in the single device @ 5V <sub>DC</sub> supply.
			0	0.2	us	@ 3.3V <sub>DC</sub> supply
Output Signal Rise/Fall Time <sup>4</sup>	$t_r/t_f$		1.5		ns	10% to 90% signal terminated 50 $\Omega$ , See figure17.
Common-Mode Transient Immunity <sup>3</sup>	CMTI	100	150		kV/ $\mu s$	$V_{IN} = V_{DDx}^2$ or 0V, $V_{CM} = 1000V$
ESD (HBM - Human body model)	ESD		$\pm 8$		kV	All pins

Notes:

<sup>1</sup>  $t_{pLH}$  = low-to-high propagation delay time,  $t_{pHL}$  = high-to-low propagation delay time. See figure 18.

<sup>2</sup>  $V_{DDx}$  is the side voltage power supply  $V_{DD}$ , where  $x = 1$  or 2.

<sup>3</sup> See Figure21 for Common-mode transient immunity (CMTI) measurement.

<sup>4</sup> Output Signal Terminated 50 $\Omega$ .

**Table 5. DC Specifications**

$V_{DD1} - V_{GND1} = V_{DD2} - V_{GND2} = 3.3V_{DC} \pm 10\%$  or  $5V_{DC} \pm 10\%$ ,  $T_A = 25^\circ C$ , unless otherwise noted.

	Symbol	Min	Typ	Max	Unit	Test Conditions/Comments
Rising Input Signal Voltage Threshold	$V_{IT+}$		$0.6 * V_{DDx}^1$	$0.7 * V_{DDx}^1$	V	
Falling Input Signal Voltage Threshold	$V_{IT-}$	$0.3 * V_{DDx}^1$	$0.4 * V_{DDx}^1$		V	
High Level Output Voltage	$V_{OH}^1$	$V_{DDx} - 0.1$	$V_{DDx}$		V	-20 $\mu A$ output current
		$V_{DDx} - 0.2$	$V_{DDx} - 0.1$		V	-2 mA output current
Low Level Output Voltage	$V_{OL}$		0	0.1	V	20 $\mu A$ output current

Input Current per Signal Channel	$I_{IN}$	-10	0.1	0.2	V	2 mA output current
$V_{DDx}^1$ Undervoltage Rising Threshold	$V_{DDxUV+}$	2.45	0.5	10	$\mu A$	$0V \leq \text{Signal voltage} \leq V_{DDx}^1$
$V_{DDx}^1$ Undervoltage Falling Threshold	$V_{DDxUV-}$	2.3	2.65	2.9	V	
$V_{DDx}^1$ Hysteresis	$V_{DDxUVH}$		2.5	2.75	V	
			0.15		V	

Notes:

<sup>1</sup>  $V_{DDx}$  is the side voltage power supply  $V_{DD}$ , where  $x = 1$  or  $2$ .**Table 6. Quiescent Supply Current** $V_{DD1} - V_{GND1} = V_{DD2} - V_{GND2} = 3.3V_{DC} \pm 10\%$  or  $5V_{DC} \pm 10\%$ ,  $T_A = 25^\circ C$ ,  $C_L = 0$  pF, unless otherwise noted.

Parameter	Symbol	Min	Typ	Max	Unit	Test Conditions	
$\pi 160U_{xx}$ Quiescent Supply Current @ $5V_{DC}$ Supply	$I_{DD1}(Q)$	461	576	749	$\mu A$	0V Input signal	
	$I_{DD2}(Q)$	2124	2655	3452	$\mu A$	0V Input signal	
	$I_{DD1}(Q)$	182	228	296	$\mu A$	5V Input signal	
	$I_{DD2}(Q)$	2302	2877	3740	$\mu A$	5V Input signal	
	@ $3.3V_{DC}$ Supply	$I_{DD1}(Q)$	338	423	550	$\mu A$	0V Input signal
		$I_{DD2}(Q)$	2088	2610	3393	$\mu A$	0V Input signal
		$I_{DD1}(Q)$	180	225	293	$\mu A$	3.3V Input signal
		$I_{DD2}(Q)$	2275	2844	3697	$\mu A$	3.3V Input signal
$\pi 161U_{xx}$ Quiescent Supply Current @ $5V_{DC}$ Supply	$I_{DD1}(Q)$	738	923	1199	$\mu A$	0V Input signal	
	$I_{DD2}(Q)$	1847	2309	3002	$\mu A$	0V Input signal	
	$I_{DD1}(Q)$	536	670	870	$\mu A$	5V Input signal	
	$I_{DD2}(Q)$	1949	2436	3167	$\mu A$	5V Input signal	
	@ $3.3V_{DC}$ Supply	$I_{DD1}(Q)$	630	788	1024	$\mu A$	0V Input signal
		$I_{DD2}(Q)$	1797	2246	2920	$\mu A$	0V Input signal
		$I_{DD1}(Q)$	529	662	860	$\mu A$	3.3V Input signal
		$I_{DD2}(Q)$	1926	2408	3130	$\mu A$	3.3V Input signal
$\pi 162U_{xx}$ Quiescent Supply Current @ $5V_{DC}$ Supply	$I_{DD1}(Q)$	1015	1269	1650	$\mu A$	0V Input signal	
	$I_{DD2}(Q)$	1570	1963	2552	$\mu A$	0V Input signal	
	$I_{DD1}(Q)$	889	1111	1444	$\mu A$	5V Input signal	
	$I_{DD2}(Q)$	1596	1995	2594	$\mu A$	5V Input signal	
	@ $3.3V_{DC}$ Supply	$I_{DD1}(Q)$	922	1152	1498	$\mu A$	0V Input signal
		$I_{DD2}(Q)$	1506	1882	2447	$\mu A$	0V Input signal
		$I_{DD1}(Q)$	878	1098	1427	$\mu A$	3.3V Input signal
		$I_{DD2}(Q)$	1578	1972	2564	$\mu A$	3.3V Input signal
$\pi 163U_{xx}$ Quiescent Supply Current @ $5V_{DC}$ Supply	$I_{DD1}(Q)$	1294	1617	2102	$\mu A$	0V Input signal	
	$I_{DD2}(Q)$	1294	1617	2102	$\mu A$	0V Input signal	
	$I_{DD1}(Q)$	1243	1554	2020	$\mu A$	5V Input signal	
	$I_{DD2}(Q)$	1243	1554	2020	$\mu A$	5V Input signal	
	@ $3.3V_{DC}$ Supply	$I_{DD1}(Q)$	1214	1518	1973	$\mu A$	0V Input signal
		$I_{DD2}(Q)$	1214	1518	1973	$\mu A$	0V Input signal
		$I_{DD1}(Q)$	1229	1536	1997	$\mu A$	3.3V Input signal
		$I_{DD2}(Q)$	1229	1536	1997	$\mu A$	3.3V Input signal

**Table 7. Total Supply Current vs. Data Throughput ( $C_L = 0$  pF)** $V_{DD1} - V_{GND1} = V_{DD2} - V_{GND2} = 3.3V_{DC} \pm 10\%$  or  $5V_{DC} \pm 10\%$ ,  $T_A = 25^\circ\text{C}$ ,  $C_L = 0$  pF, unless otherwise noted.

Parameter	Symbol	2 Kbps			50Kbps			150Kbps			Unit
		Min	Typ	Max	Min	Typ	Max	Min	Typ	Max	
$\pi 160\text{Uxx}$ Supply Current @ $5V_{DC}$	$I_{DD1}$		0.39	0.59		0.39	0.59		0.39	0.59	mA
	$I_{DD2}$		2.76	4.14		2.79	4.19		2.82	4.23	mA
@ $3.3V_{DC}$	$I_{DD1}$		0.30	0.45		0.30	0.45		0.30	0.45	mA
	$I_{DD2}$		2.73	4.10		2.73	4.10		2.76	4.14	mA
$\pi 161\text{Uxx}$ Supply Current @ $5V_{DC}$	$I_{DD1}$		0.79	1.18		0.79	1.19		0.80	1.19	mA
	$I_{DD2}$		2.37	3.56		2.39	3.59		2.42	3.63	mA
@ $3.3V_{DC}$	$I_{DD1}$		0.71	1.06		0.71	1.07		0.71	1.07	mA
	$I_{DD2}$		2.33	3.50		2.33	3.50		2.35	3.53	mA
$\pi 162\text{Uxx}$ Supply Current @ $5V_{DC}$	$I_{DD1}$		1.18	1.77		1.19	1.79		1.21	1.82	mA
	$I_{DD2}$		1.97	2.96		1.99	2.99		2.02	3.03	mA
@ $3.3V_{DC}$	$I_{DD1}$		1.11	1.67		1.12	1.68		1.12	1.68	mA
	$I_{DD2}$		1.92	2.88		1.93	2.90		1.94	2.91	mA
$\pi 163\text{Uxx}$ Supply Current @ $5V_{DC}$	$I_{DD1}$		1.59	2.39		1.59	2.39		1.62	2.43	mA
	$I_{DD2}$		1.59	2.39		1.59	2.39		1.62	2.43	mA
@ $3.3V_{DC}$	$I_{DD1}$		1.53	2.30		1.53	2.30		1.53	2.30	mA
	$I_{DD2}$		1.53	2.30		1.53	2.30		1.53	2.30	mA

**INSULATION AND SAFETY RELATED SPECIFICATIONS****Table 8. Insulation Specifications**

Parameter	Symbol	Value		Unit	Test Conditions/Comments
		$\pi 16xU3x$	$\pi 16xU6x$		
Rated Dielectric Insulation Voltage		3000	6000	V rms	1-minute duration
Minimum External Air Gap (Clearance)	L (CLR)	4	8	mm min	Measured from input terminals to output terminals, shortest distance through air
Minimum External Tracking (Creepage)	L (CRP)	4	8	mm min	Measured from input terminals to output terminals, shortest distance path along body
Minimum Internal Gap (Internal Clearance)		11	21	$\mu\text{m}$ min	Insulation distance through insulation
Tracking Resistance (Comparative Tracking Index)	CTI	>400	>400	V	DIN IEC 112/VDE 0303 Part 1
Material Group		II	II		Material Group (DIN VDE 0110, 1/89, Table 1)

**PACKAGE CHARACTERISTICS****Table 9. Package Characteristics**

Parameter	Symbol	Typical Value		Unit	Test Conditions/Comments
		$\pi 16xU3x$	$\pi 16xU6x$		
Resistance (Input to Output) <sup>1</sup>	$R_{I-O}$	$10^{11}$	$10^{11}$	$\Omega$	
Capacitance (Input to Output) <sup>1</sup>	$C_{I-O}$	0.6	0.6	pF	@1MHz
Input Capacitance <sup>2</sup>	$C_i$	3	3	pF	@1MHz
IC Junction to Ambient Thermal Resistance	$\theta_{JA}$	76	45	$^\circ\text{C}/\text{W}$	Thermocouple located at center of package underside

Notes:

<sup>1</sup>The device is considered a 2-terminal device; SOIC-16 Pin 1 - Pin 8(WSOIC-16 Pin 1-Pin8) are shorted together as the one terminal, and SOIC-16 Pin 9 - Pin 16(WSOIC-16 Pin 9-Pin16) are shorted together as the other terminal.

<sup>2</sup>Testing from the input signal pin to ground.

## REGULATORY INFORMATION

See Table 10 and the Insulation Lifetime section for details regarding recommended maximum working voltages for specific cross isolation waveforms and insulation levels.

**Table 10. Regulatory**

Regulatory	$\pi 16xU3x$	$\pi 16xU6x$
<b>UL</b>	Recognized under UL 1577 Component Recognition Program <sup>1</sup> Single Protection, 3000 V rms Isolation Voltage File (E494497)	Recognized under UL 1577 Component Recognition Program <sup>1</sup> Single Protection, 6000 V rms Isolation Voltage File (pending)
<b>CSA</b>	Approved under CSA Component Acceptance Notice 5A CSA 60950-1-07+A1+A2 and IEC 60950-1, second edition, +A1+A2: Basic insulation at 500 V rms (707 V peak) Reinforced insulation at 250 V rms (353 V peak) File (pending)	Approved under CSA Component Acceptance Notice 5A CSA 60950-1-07+A1+A2 and IEC 60950-1, second edition, +A1+A2: Basic insulation at 845 V rms (1200 V peak) Reinforced insulation at 422 V rms (600 V peak) File (pending)
<b>VDE</b>	DIN V VDE V 0884-10 (VDE V 0884-10):2006-12 <sup>2</sup> Basic insulation, $V_{IORM} = 707$ V peak, $V_{IOSM} = 4615$ V peak File (40047929)	DIN V VDE V 0884-10 (VDE V 0884-10):2006-12 <sup>2</sup> Basic insulation, $V_{IORM} = 1200$ V peak, $V_{IOSM} = 7000$ V peak File (pending)
<b>CQC</b>	Certified under CQC11-471543-2012 GB4943.1-2011  Basic insulation at 500 V rms (707 V peak) working voltage  Reinforced insulation at 250 V rms (353 V peak) File (pending)	Certified under CQC11-471543-2012 GB4943.1-2011  Basic insulation at 845 V rms (1200 V peak) working voltage  Reinforced insulation at 422 V rms (600 V peak) File (pending)

Notes:

<sup>1</sup>In accordance with UL 1577, each  $\pi 160U3x/\pi 161U3x/\pi 162U3x/\pi 163U3x$  is proof tested by applying an insulation test voltage  $\geq 3600$  V rms for 1 sec; each  $\pi 160U6x/\pi 161U6x/\pi 162U6x/\pi 163U6x$  is proof tested by applying an insulation test voltage  $\geq 7200$  V rms for 1 sec

<sup>2</sup>In accordance with DIN V VDE V 0884-10, each  $\pi 160U3x/\pi 161U3x/\pi 162U3x/\pi 163U3x$  is proof tested by applying an insulation test voltage  $\geq 1326$  V peak for 1 sec (partial discharge detection limit = 5 pC); each  $\pi 160U6x/\pi 161U6x/\pi 162U6x/\pi 163U6x$  is proof tested by  $\geq 2250$  V peak for 1 sec. The \* marking branded on the component designates DIN V VDE V 0884-10 approval.

## DIN V VDE V 0884-10 (VDE V 0884-10) INSULATION CHARACTERISTICS

These isolators are suitable for reinforced electrical isolation only within the safety limit data. Protective circuits ensure the maintenance of the safety data. The \* marking on packages denotes DIN V VDE V 0884-10 approval.

**Table 11. VDE Insulation Characteristics**

Description	Test Conditions/Comments	Symbol	Characteristic		Unit
			$\pi 16xx3x$	$\pi 16xx6x$	
Installation Classification per DIN VDE 0110  For Rated Mains Voltage $\leq 150$ V rms			I to IV	I to IV	



For Rated Mains Voltage $\leq 300$ V rms			I to III	I to III	
For Rated Mains Voltage $\leq 400$ V rms			I to III	I to III	
Climatic Classification			40/105/21	40/105/21	
Pollution Degree per DIN VDE 0110, Table 1			2	2	
Maximum Working Insulation Voltage		$V_{IORM}$	707	1200	V peak
Input to Output Test Voltage, Method B1	$V_{IORM} \times 1.875 = V_{pd(m)}$ , 100% production test, $t_{ini} = t_m = 1$ sec, partial discharge $< 5$ pC	$V_{pd(m)}$	1326	2250	V peak
Input to Output Test Voltage, Method A					
After Environmental Tests Subgroup 1	$V_{IORM} \times 1.5 = V_{pd(m)}$ , $t_{ini} = 60$ sec, $t_m = 10$ sec, partial discharge $< 5$ pC	$V_{pd(m)}$	1061	1800	V peak
After Input and/or Safety Test Subgroup 2 and Subgroup 3	$V_{IORM} \times 1.2 = V_{pd(m)}$ , $t_{ini} = 60$ sec, $t_m = 10$ sec, partial discharge $< 5$ pC		849	1440	V peak
Highest Allowable Overvoltage		$V_{IOTM}$	4200	8500	V peak
Surge Isolation Voltage Basic	Basic insulation, 1.2 $\mu$ s rise time, 50 $\mu$ s, 50% fall time	$V_{IOSM}$	4615	7000	V peak
Surge Isolation Voltage Reinforced	Reinforced insulation, 1.2 $\mu$ s rise time, 50 $\mu$ s, 50% fall time	$V_{IOSM}$			V peak
Safety Limiting Values	Maximum value allowed in the event of a failure (see Figure 7)				
Maximum Junction Temperature		$T_S$	150	150	$^{\circ}$ C
Total Power Dissipation at 25 $^{\circ}$ C		$P_S$	1.56	2.78	W
Insulation Resistance at $T_S$	$V_{IO} = 800$ V	$R_S$	$>10^9$	$>10^9$	$\Omega$

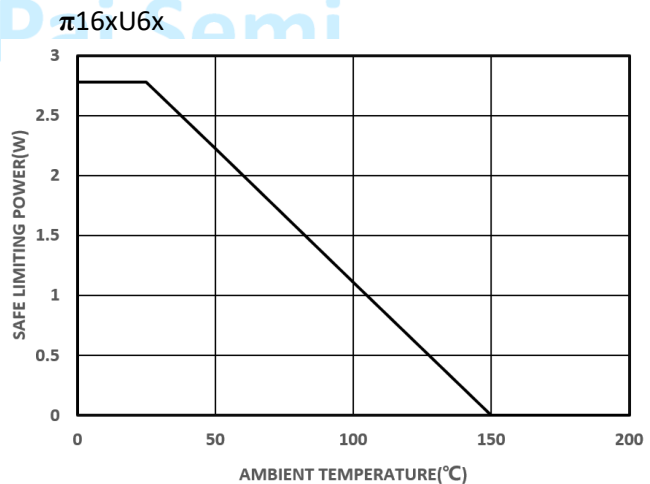
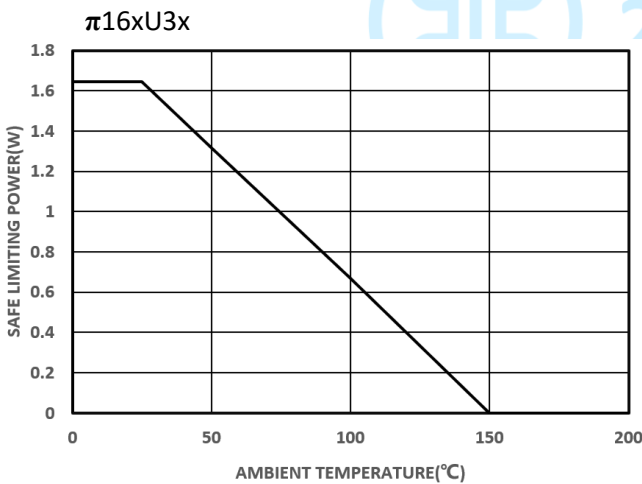

Figure7. Thermal Derating Curve, Dependence of Safety Limiting Values with Ambient Temperature per VDE

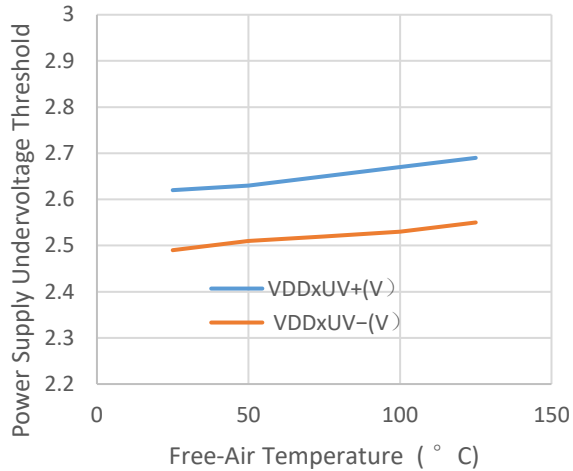

Figure 8. UVLO vs. Free-Air Temperature

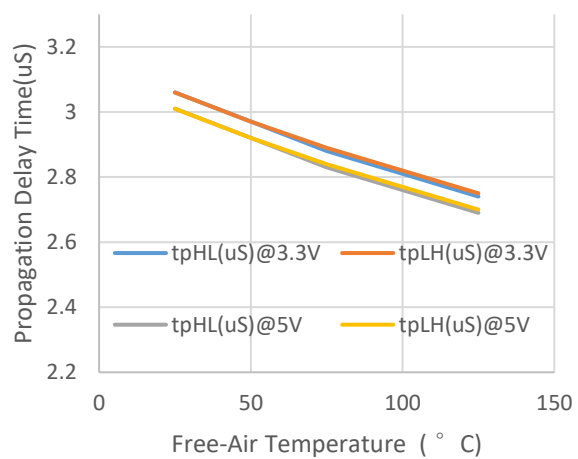

Figure 9. Propagation Delay Time vs. Free-Air Temperature

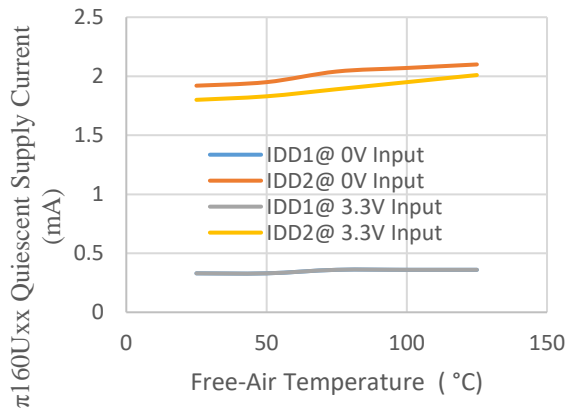

Figure 10.  $\pi$ 160Uxx Quiescent Supply Current with 3.3V Supply vs. Free-Air Temperature

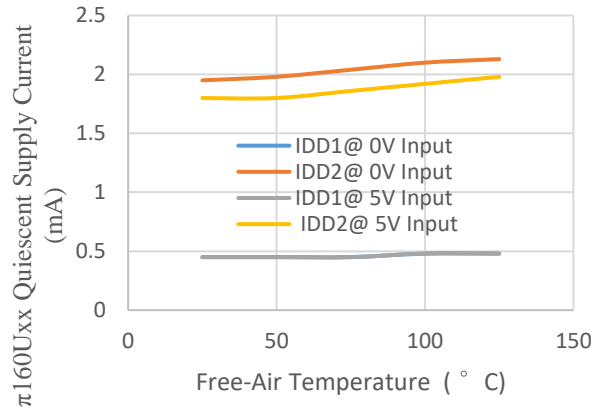

Figure 11.  $\pi$ 160Uxx Quiescent Supply Current with 5.0V Supply vs. Free-Air Temperature

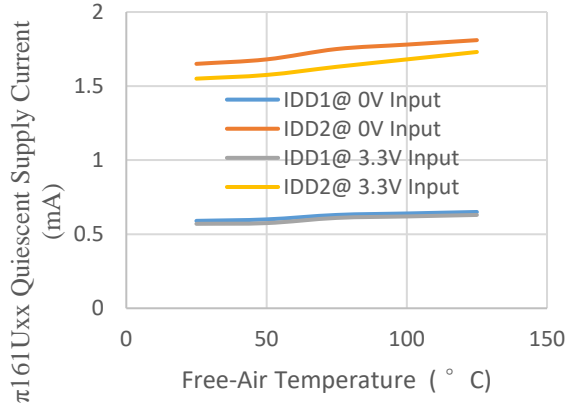

Figure 12.  $\pi$ 161Uxx Quiescent Supply Current with 3.3V Supply vs. Free-Air Temperature

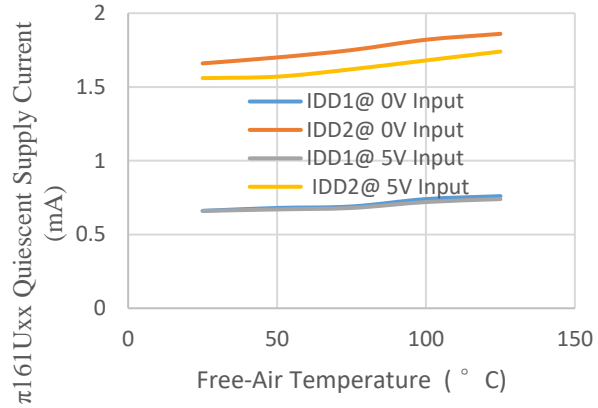
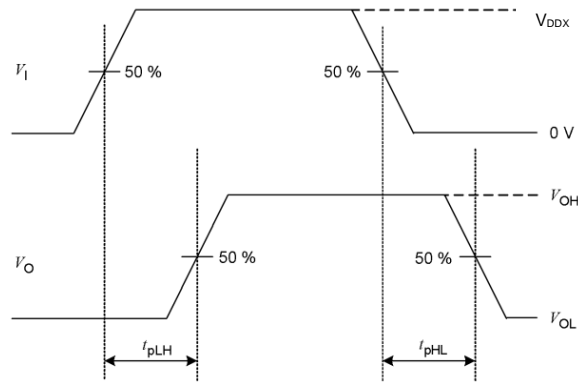
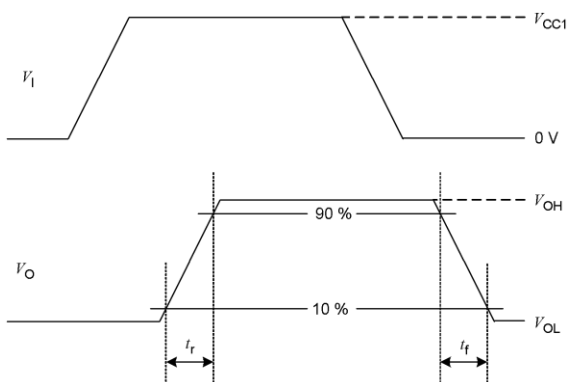
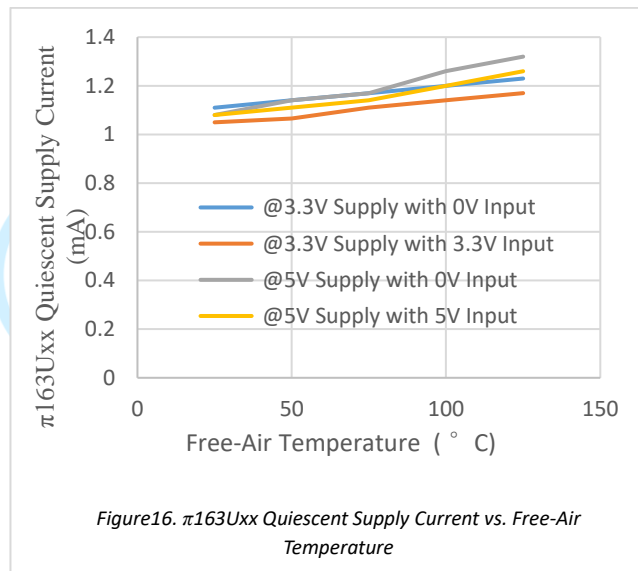
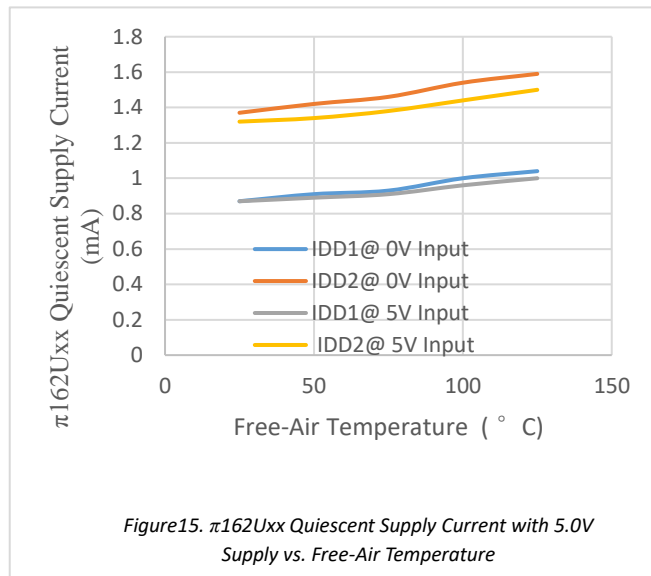
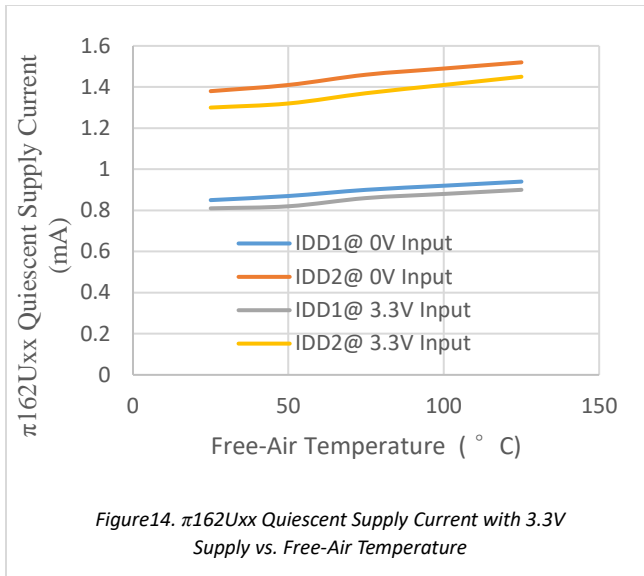

Figure 13.  $\pi$ 161Uxx Quiescent Supply Current with 5.0V Supply vs. Free-Air Temperature



## APPLICATIONS INFORMATION

### OVERVIEW

The  $\pi 1xxxx$  are 2PaiSemi digital isolators product family based on 2PaiSEMI unique **iDivider** technology. Intelligent voltage **Divider** technology (**iDivider** technology) is a new generation digital isolator technology invented by 2PaiSEMI. It uses the principle of capacitor voltage divider to transmit signal directly cross the isolator capacitor without signal modulation and demodulation. Compare to the traditional Opto-couple technology, icoupler technology, OOK technology, **iDivider** is a more essential and concise isolation signal transmit technology which leads to greatly simplification on circuit design and therefore significantly improves device performance, such as lower power consumption, faster speed, enhanced anti-interference ability, lower noise.

By using matured standard semiconductor CMOS technology and the innovative **iDivider** design, these isolation components provide outstanding performance characteristics and reliability superior to alternatives such as optocoupler devices and other integrated isolators. The  $\pi 1xxxx$  isolator data channels are independent and are available in a variety of configurations with a withstand voltage rating of 1.5 kV rms to 6.0 kV rms and the data rate from DC up to 600Mbps (see the Ordering Guide).

The  $\pi 160Uxx/\pi 161Uxx/\pi 162Uxx/\pi 163Uxx$  are the outstanding 150Kbps hexa-channel digital isolators with the enhanced ESD capability. the devices transmit data across an isolation barrier by layers of silicon dioxide isolation.

The devices operate with the supply voltage on either side ranging from 3.0 V to 5.5 V, offering voltage translation of 3.3 V and 5 V logic.

The  $\pi 160Uxx/\pi 161Uxx/\pi 162Uxx/\pi 163Uxx$  have very low propagation delay and high speed. The input/output design techniques allow logic and supply voltages over a wide range from 3.0 V to 5.5 V, offering voltage translation of 3.3 V and 5 V logic. The architecture is designed for high common-mode transient immunity and high immunity to electrical noise and magnetic interference.

See the Ordering Guide for the model numbers that have the fail-safe output state of low or high.

### PCB LAYOUT

The low-ESR ceramic bypass capacitors must be connected between  $V_{DD1}$  and  $GND_1$  and between  $V_{DD2}$  and  $GND_2$ . The bypass capacitors are placed on the PCB as close to the isolator device as possible. The recommended bypass capacitor value is between 0.1  $\mu F$  and 10  $\mu F$ . To enhance the robustness of a design,

the user may also include resistors (50–300  $\Omega$ ) in series with the inputs and outputs if the system is excessively noisy.

Avoid reducing the isolation capability, Keep the space underneath the isolator device free from metal such as planes, pads, traces and vias.

To minimize the impedance of the signal return loop, keep the solid ground plane directly underneath the high-speed signal path, the closer the better. The return path will couple between the nearest ground plane to the signal path. Keep suitable trace width for controlled impedance transmission lines interconnect.

To reduce the rise time degradation, keep the length of input/output signal traces as short as possible, and route low inductance loop for the signal path and It's return path.

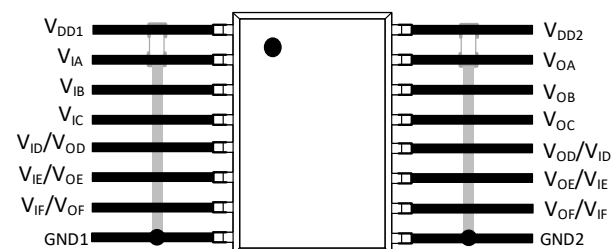

Figure19. Recommended Printed Circuit Board Layout

### CMTI MEASUREMENT

To measure the Common-Mode Transient Immunity (CMTI) of  $\pi 1xxxx$  isolator under specified common-mode pulse magnitude ( $V_{CM}$ ) and specified slew rate of the common-mode pulse ( $dV_{CM}/dt$ ) and other specified test or ambient conditions, The common-mode pulse generator ( $G_1$ ) will be capable of providing fast rising and falling pulses of specified magnitude and duration of the common-mode pulse ( $V_{CM}$ ) and the maximum common-mode slew rates ( $dV_{CM}/dt$ ) can be applied to  $\pi 1xxxx$  isolator coupler under measurement. The common-mode pulse is applied between one side ground  $GND_1$  and the other side ground  $GND_2$  of  $\pi 1xxxx$  isolator and shall be capable of providing positive transients as well as negative transients.

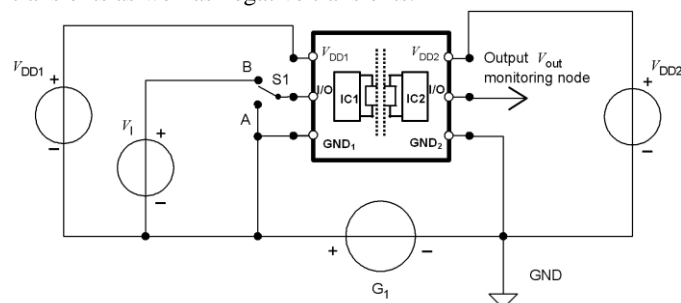

Figure20. Common-mode transient immunity (CMTI) measurement

OUTLINE DIMENSIONS

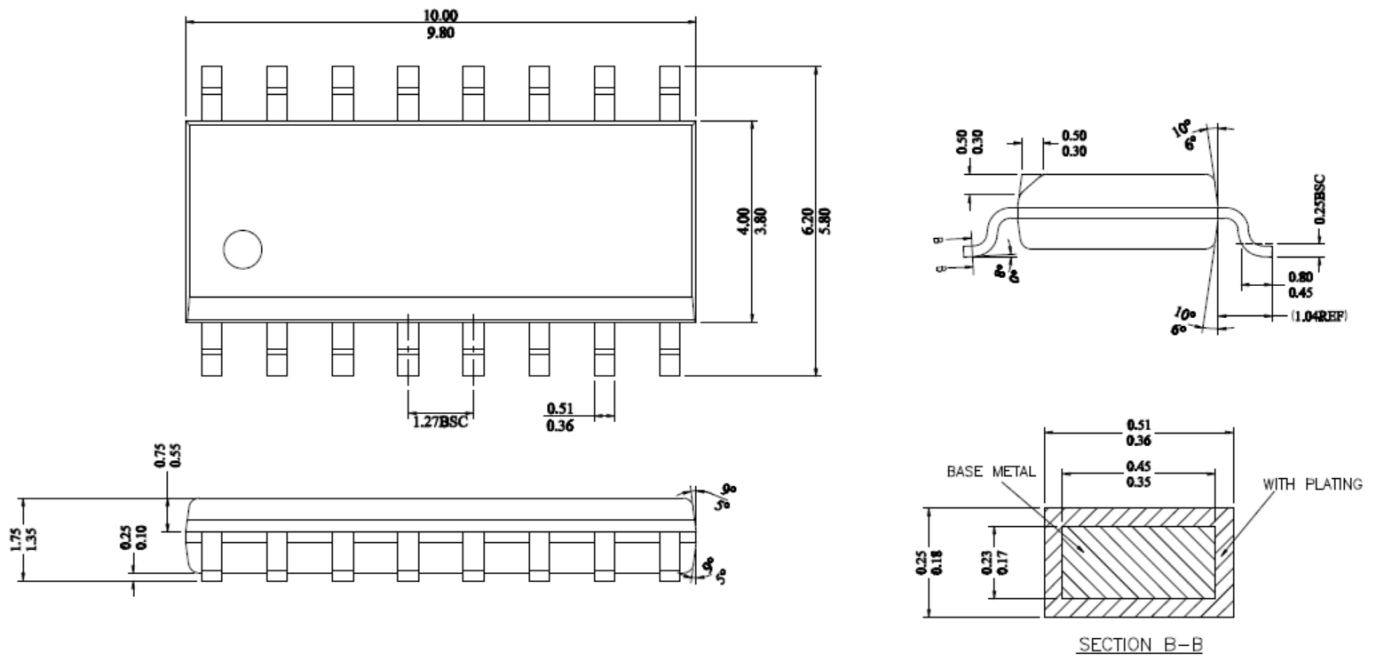

Figure 21. 16-Lead Standard Small Outline Package [16-Lead SOIC\_N]

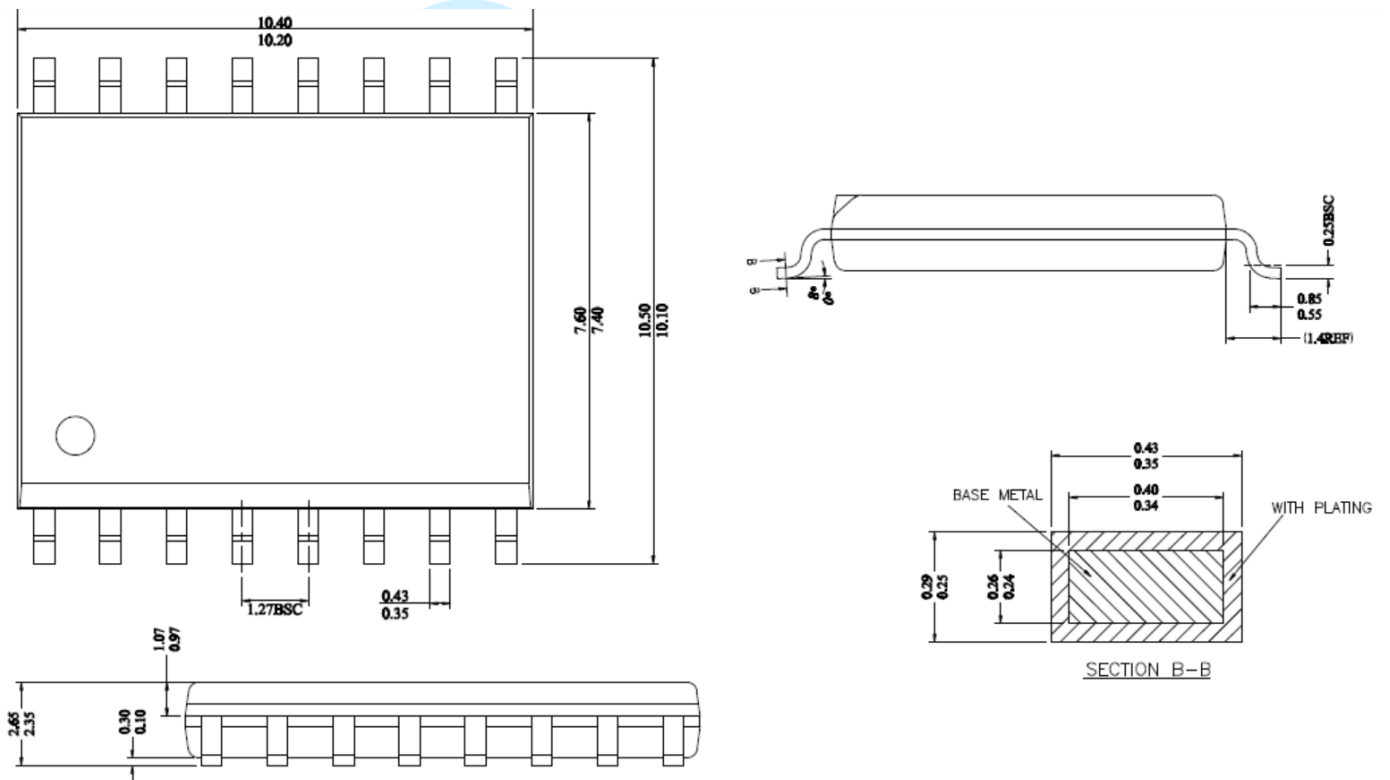
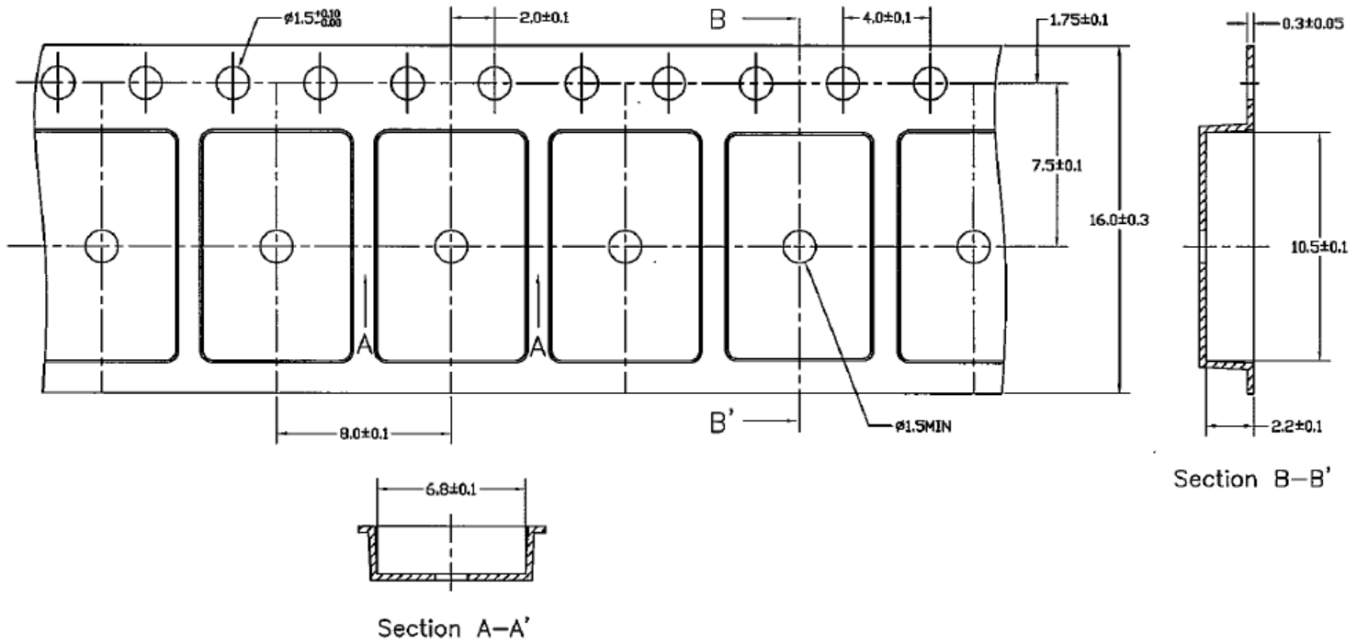

Figure 22. 16-Lead Wide Body Outline Package [16-Lead SOIC\_W]

REEL INFORMATION

16-Lead SOIC\_N



16-Lead SOIC\_W

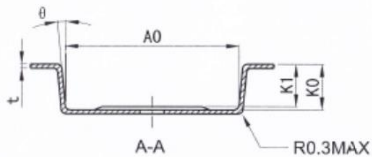
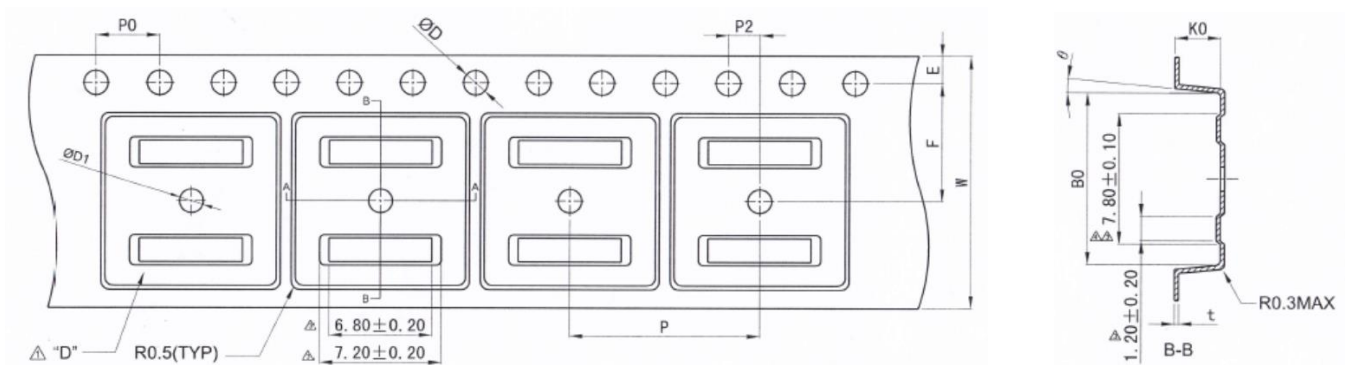

Items	Size(mm)
E	$1.75 \pm 0.10$
F	$7.50 \pm 0.05$
P2	$2.00 \pm 0.05$
D	$1.55 \pm 0.05$
D1	$1.5 \pm 0.10$
P0	$4.00 \pm 0.10$
10P0	$40.00 \pm 0.20$

Items	Size(mm)
W	$16.00 \pm 0.30$
P	$12.00 \pm 0.10$
A0	$10.90 \pm 0.10$
B0	$10.80 \pm 0.10$
K0	$3.00 \pm 0.10$
t	$0.30 \pm 0.05$
K1	$2.70 \pm 0.10$
$\theta$	$5^\circ \text{ TYP}$

**ORDERING GUIDE**

Model Name		Temperature Range	No. of Inputs, V <sub>DD1</sub> Side	No. of Inputs, V <sub>DD2</sub> Side	Withstand Voltage Rating (kV rms)	Fail-Safe Output State	Package Description	Package Option	Quantity
$\pi$ 160U31	Pai160U31	-40°C to +125°C	6	0	3	High	16-Lead SOIC_N	S-16-N	2500 per reel
$\pi$ 160U30	Pai160U30	-40°C to +125°C	6	0	3	Low	16-Lead SOIC_N	S-16-N	2500 per reel
$\pi$ 161U31	Pai161U31	-40°C to +125°C	5	1	3	High	16-Lead SOIC_N	S-16-N	2500 per reel
$\pi$ 161U30	Pai161U30	-40°C to +125°C	5	1	3	Low	16-Lead SOIC_N	S-16-N	2500 per reel
$\pi$ 162U31	Pai162U31	-40°C to +125°C	4	2	3	High	16-Lead SOIC_N	S-16-N	2500 per reel
$\pi$ 162U30	Pai162U30	-40°C to +125°C	4	2	3	Low	16-Lead SOIC_N	S-16-N	2500 per reel
$\pi$ 163U31	Pai163U31	-40°C to +125°C	3	3	3	High	16-Lead SOIC_N	S-16-N	2500 per reel
$\pi$ 163U30	Pai163U30	-40°C to +125°C	3	3	3	Low	16-Lead SOIC_N	S-16-N	2500 per reel
$\pi$ 160U61	Pai160U61	-40°C to +125°C	6	0	6	High	16-Lead SOIC_W	S-16-W	1500 per reel
$\pi$ 160U60	Pai160U60	-40°C to +125°C	6	0	6	Low	16-Lead SOIC_W	S-16-W	1500 per reel
$\pi$ 161U61	Pai161U61	-40°C to +125°C	5	1	6	High	16-Lead SOIC_W	S-16-W	1500 per reel
$\pi$ 161U60	Pai161U60	-40°C to +125°C	5	1	6	Low	16-Lead SOIC_W	S-16-W	1500 per reel
$\pi$ 162U61	Pai162U61	-40°C to +125°C	4	2	6	High	16-Lead SOIC_W	S-16-W	1500 per reel
$\pi$ 162U60	Pai162U60	-40°C to +125°C	4	2	6	Low	16-Lead SOIC_W	S-16-W	1500 per reel
$\pi$ 163U61	Pai163U61	-40°C to +125°C	3	3	6	High	16-Lead SOIC_W	S-16-W	1500 per reel
$\pi$ 163U60	Pai163U60	-40°C to +125°C	3	3	6	Low	16-Lead SOIC_W	S-16-W	1500 per reel

Notes:

<sup>1</sup>  $\pi$ 16xxxxQ special for Auto, qualified for AEC-Q100

**PART NUMBER NAMED RULE**

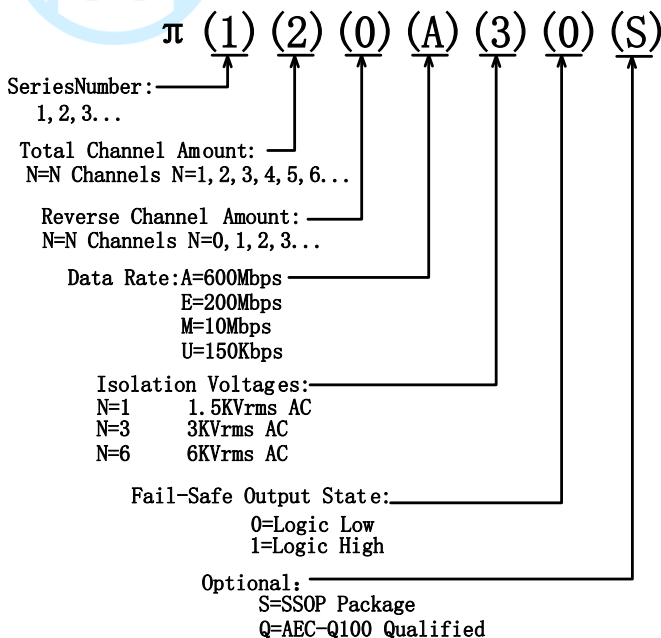

Notes: Pai16xxxx is equals to  $\pi$ 16xxxx in the customer BOM

## REVISION HISTORY

Revision	Updated	Date	Page	Change Record
1	Devin	2018/09/19	All	Initial version
2	Devin	2018/11/28	P1,P12	Changed C <sub>IN</sub> , C <sub>OUT</sub> in Figure2 from 0.1uF to 1uF. Changed the recommended bypass capacitor value from between 0.1 $\mu$ F and 1 $\mu$ F to between 0.1 $\mu$ F and 10 $\mu$ F.
3	Devin	2019/09/08	P1,P13, P15,P16	P1: Changed the address from 'Room 19307, Building 8, No.498, GuoShouJing Road' to 'Room 308-309, No.22, Boxia Road'; Add <b>iDivider</b> technology description in General Description. Changed C <sub>IN</sub> , C <sub>OUT</sub> in Figure2 from 1uF to 0.1uF. P13: Add <b>iDivider</b> technology description in overview. P15: Updated 16-Lead SOIC_W reel drawing. P16: Add character 'S' and 'Q' in part number named rule; Changed the SOIC_W quantity from '1000 per reel' to '1500 per reel'.

