

P-Channel Enhancement Mode MOSFET

Feature

- 20V/-3A $R_{DS(ON)} = 120\text{m}\Omega(\text{MAX}) @V_{GS} = -4.5\text{V}$.
 $R_{DS(ON)} = 150\text{m}\Omega(\text{MAX}) @V_{GS} = -2.5\text{V}$.
- Super High dense cell design for extremely low $R_{DS(ON)}$
- Reliable and Rugged
- SC-59 for Surface Mount Package

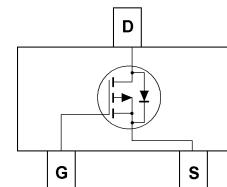

SC-59

Applications

- Power Management
- Portable Equipment and Battery Powered Systems.

Absolute Maximum Ratings TA=25°C Unless Otherwise noted

Parameter	Symbol	Limit	Units
Drain-Source Voltage	V_{DS}	-20	V
Gate-Source Voltage	V_{GS}	±10	V
Drain Current-Continuous	I_D	-3	A

Electrical Characteristics TA=25°C Unless Otherwise noted

Parameter	Symbol	Test Conditions	Min	Typ.	Max	Units
Off Characteristics						
Drain to Source Breakdown Voltage	BVDSS	$V_{GS}=0\text{V}, I_D=-250\mu\text{A}$	-20	-	-	V
Zero-Gate Voltage Drain Current	I_{DSS}	$V_{DS}=-20\text{V}, V_{GS}=0\text{V}$	-	-	-1	μA
Gate Body Leakage Current, Forward	I_{GSSF}	$V_{GS}=10\text{V}, V_{DS}=0\text{V}$	-	-	100	nA
Gate Body Leakage Current, Reverse	I_{GSSR}	$V_{GS}=-10\text{V}, V_{DS}=0\text{V}$	-	-	-100	nA
On Characteristics						
Gate Threshold Voltage	$V_{GS(th)}$	$V_{GS}=V_{DS}, I_D=-250\mu\text{A}$	-0.4	-	-1.0	V
Static Drain-source On-Resistance	$R_{DS(ON)}$	$V_{GS}=-4.5\text{V}, I_D=-3.0\text{A}$	-	--	120	$\text{m}\Omega$
		$V_{GS}=-2.5\text{V}, I_D=-2.0\text{A}$	-	--	150	$\text{m}\Omega$
Drain-Source Diode Characteristics and Maximum Ratings						
Drain-Source Diode Forward Voltage	VSD	$V_{GS}=0\text{V}, I_S=-1.25\text{A}$			-1.2	V

Typical Characteristics

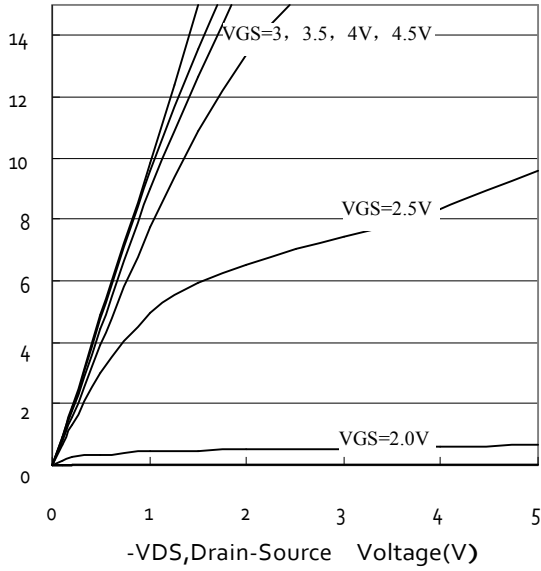

Figure 1. Output Characteristics

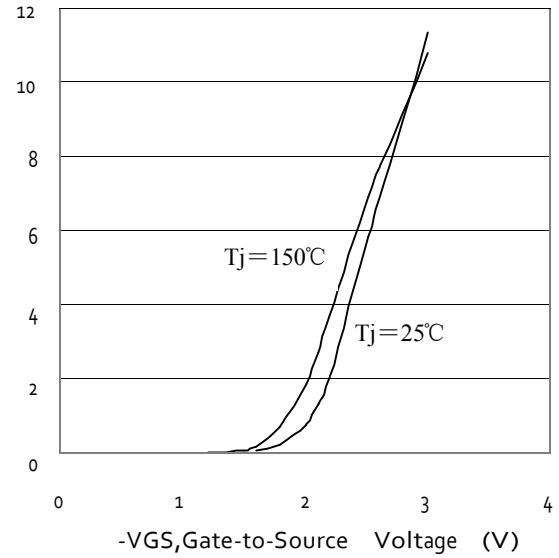

Figure 2. Transfer Characteristics

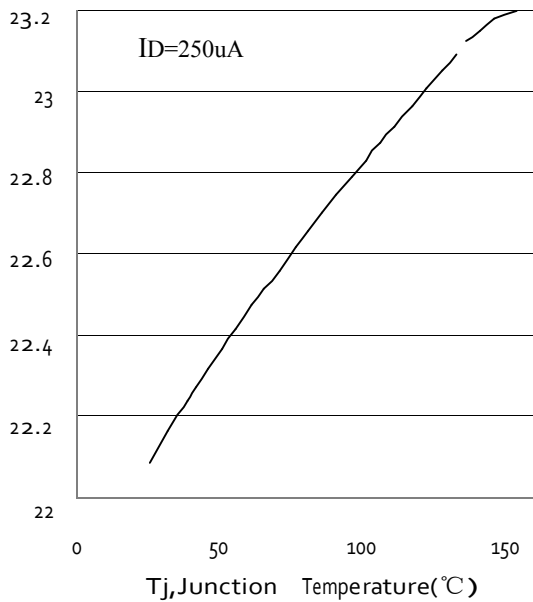

Figure 3. Breakdown Voltage Variation with Temperature

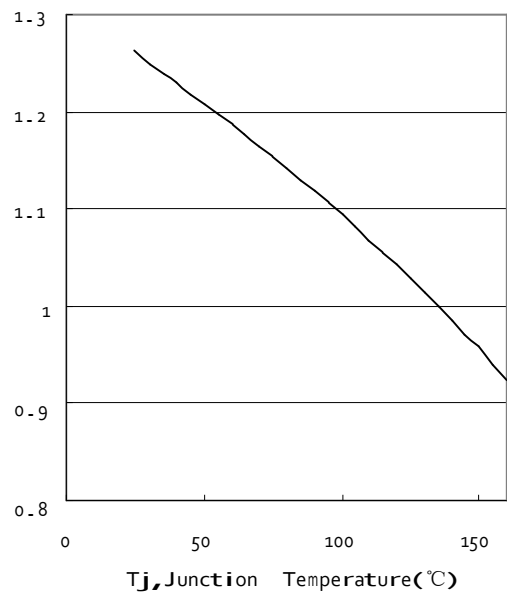

Figure 4. Gate Threshold Variation with Temperature

Typical Characteristics

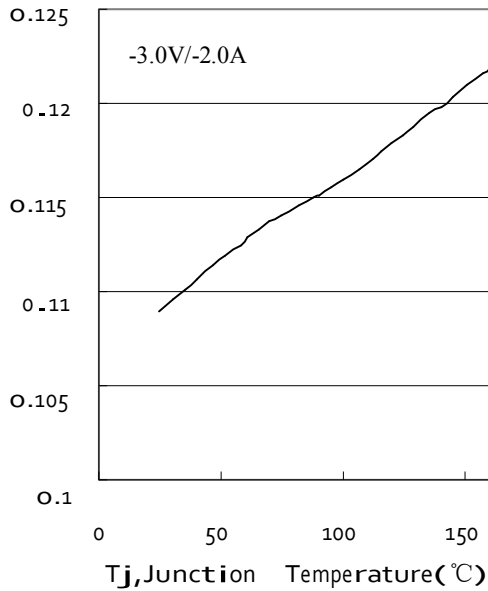

Figure 5. On-Resistance Variation with Temperature

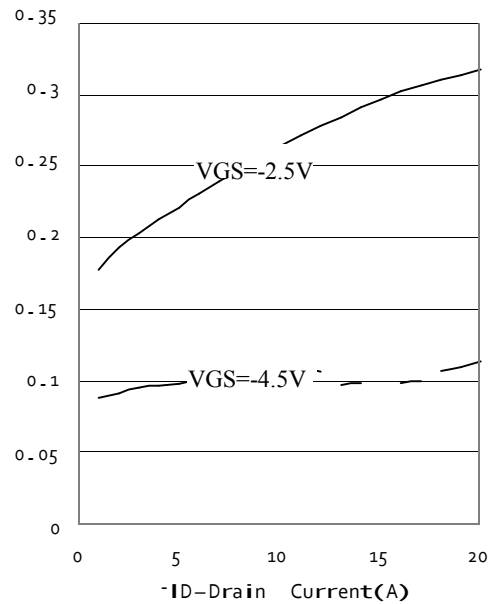

Figure 6. On-Resistance vs. Drain Current

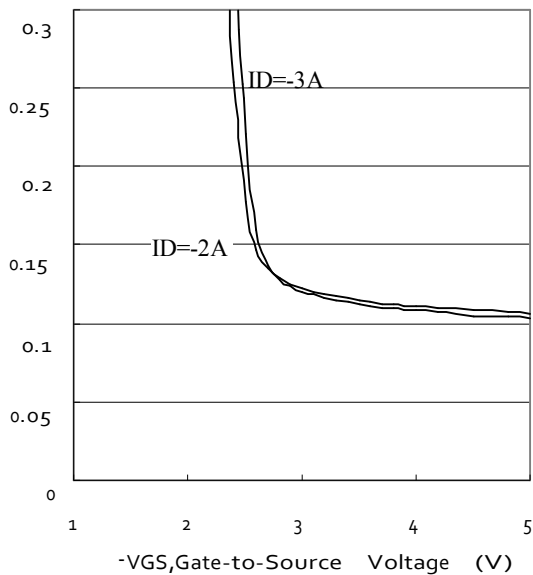

Figure 7. On-Resistance vs. Gate-to-Source Voltage

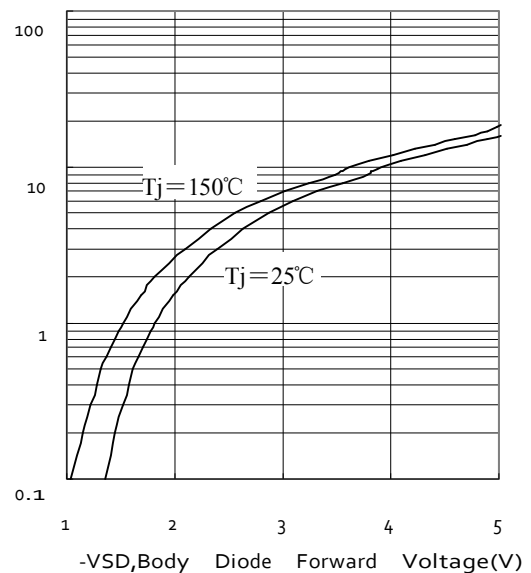
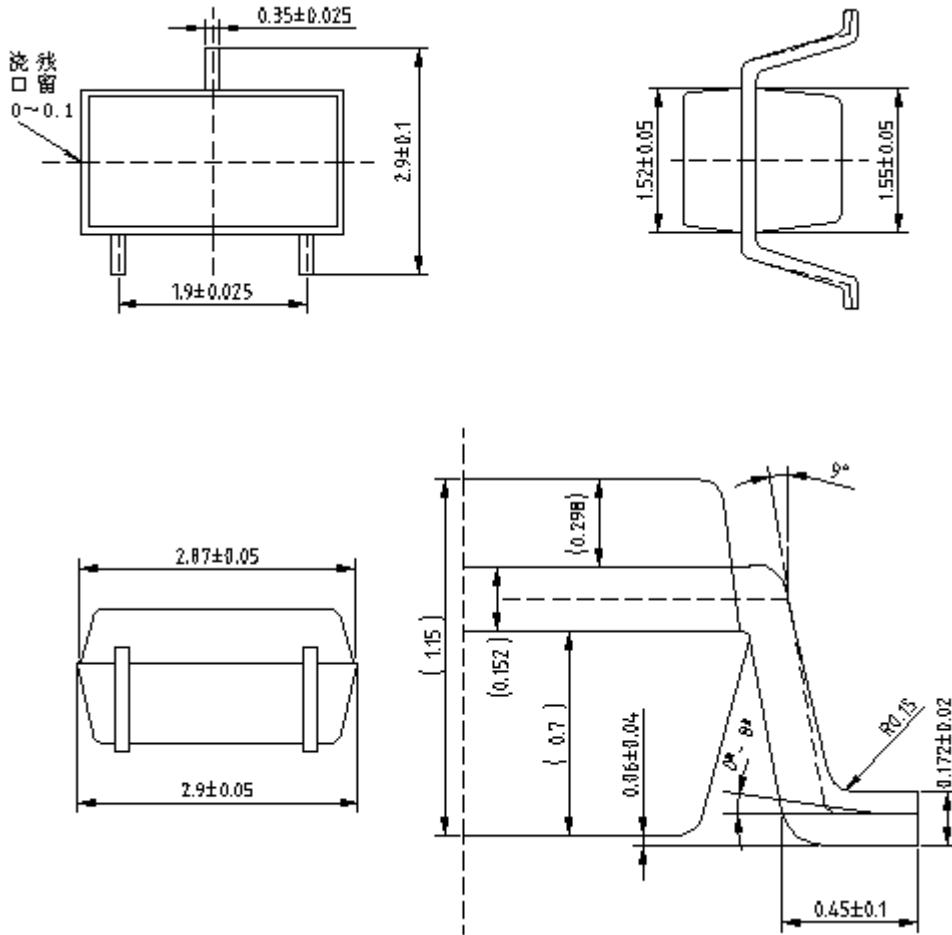

Figure 8. Source-Drain Diode Forward Voltage



SC-59 Carrier Tape

