

Surge arrester

2-Electrode arrester

Series/Type: DG2R350L

Customer:

Version/Date: Issue 03/2015-07-19

Surge arrester

2-Electrode arrester

DG2R350L

Features	Applications
<ul style="list-style-type: none"> ● Extremely small size ● Extremely fast response time ● Excellent SMD handling ● Stable performance over life ● Very low capacitance ● High insulation resistance ● RoHS-compatible ● UL-identification, No:E311500 	<ul style="list-style-type: none"> ● Splitter ● PCI Cards ● Morden ● Line cards

Electrical specifications

DC breakdown voltage ^{2) 3)} ——Circuit current less than 2mA	350 ±20	V %
Impulse breakdown voltage ¹⁾ at 1kv/us -Typical values of distribution	≤ 800	V
Insulation resistance at DC 100V	≥ 1	GΩ
Capacitance at 1MHz ²⁾	≤ 1	Pf
Service life ²⁾		
10 operations 8/20us	5	KA
10 operations 50Hz,1S	5	A
1 operation 50Hz,9 cycles	100	A
500 operations 10/1000us	100	A
Weight	~0.7	g
Storage and operations temperature	-40...+90	°C
Climatic category (GB/T 9043, IEC61643-1)	40/90/21	
Marking,Blue positive	DG2R350L	



Tel: +86-510-81707285

Fax: +86-510-81707277

www.jsdgme.com

DC breakdown voltage

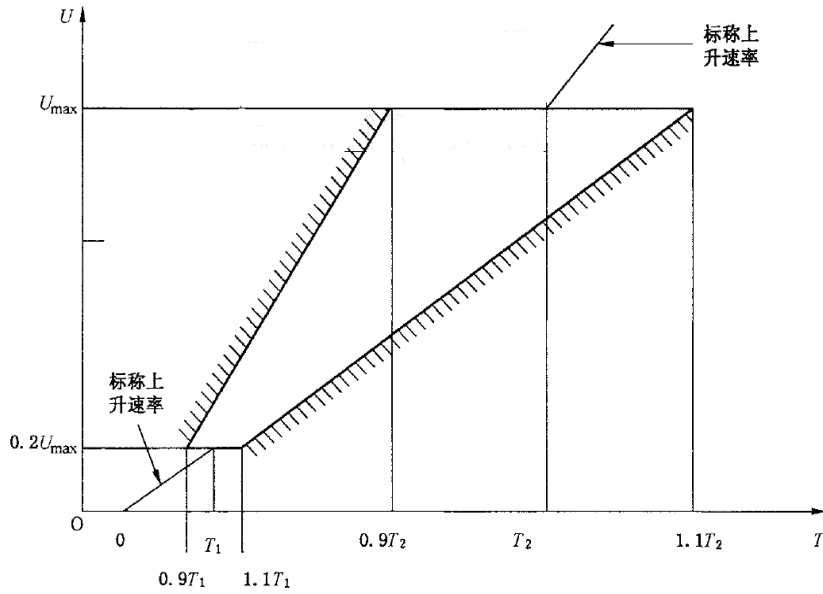

8/20us, Test wave

$T_1 = 1.25T = 8\mu s \pm 20\%$

$T_2 = 20\mu s \pm 20\%$

10/700us, Test Wave

$T_1 = 1.67T = 10\mu s \pm 20\%$

$T_2 = 700\mu s \pm 20\%$

10/1000us, Test Wave

$T_1 = 1.67T = 10\mu s \pm 20\%$

$T_2 = 1000\mu s \pm 20\%$

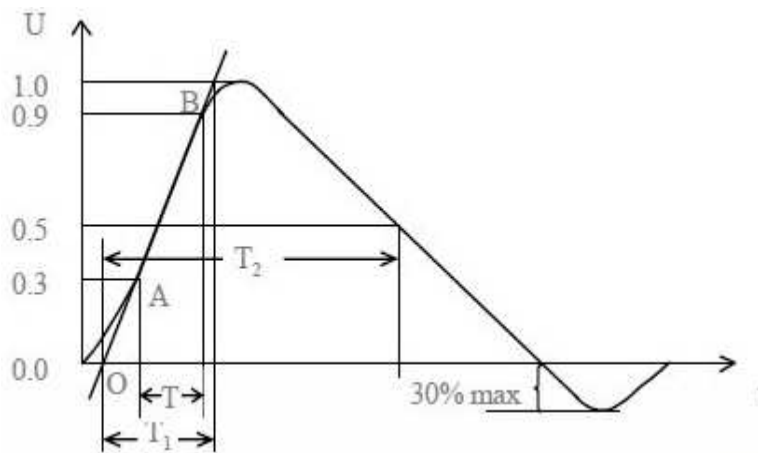

Recommended wave soldering profile

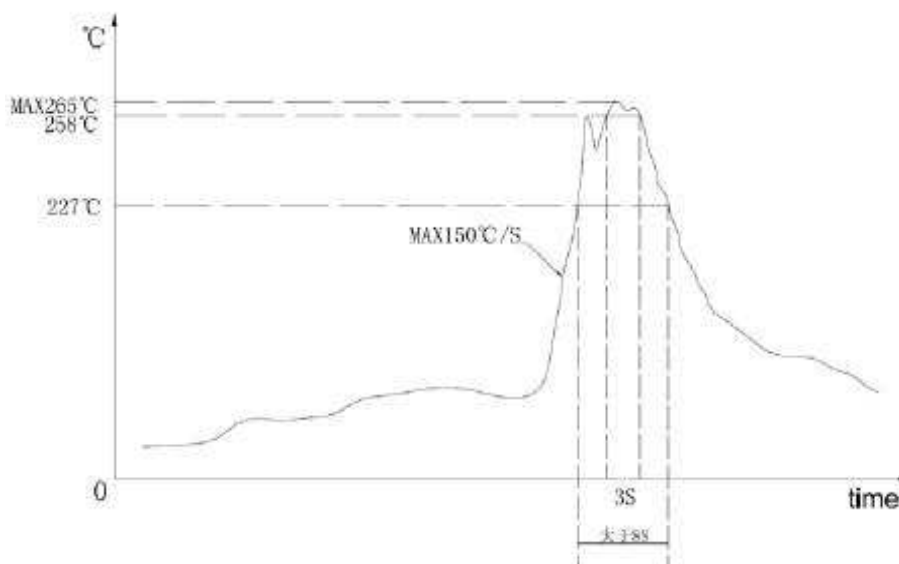

Surge arrester

2-Electrode arrester

DG2R350L

- 1) Sampling size in accordance to AQL(C=0)
- 2) DC spark-over voltage $\pm 30\%$ after load
- 3) Tests according to ITU-T Rec. K. 12 and IEC61643-1

Dimensions

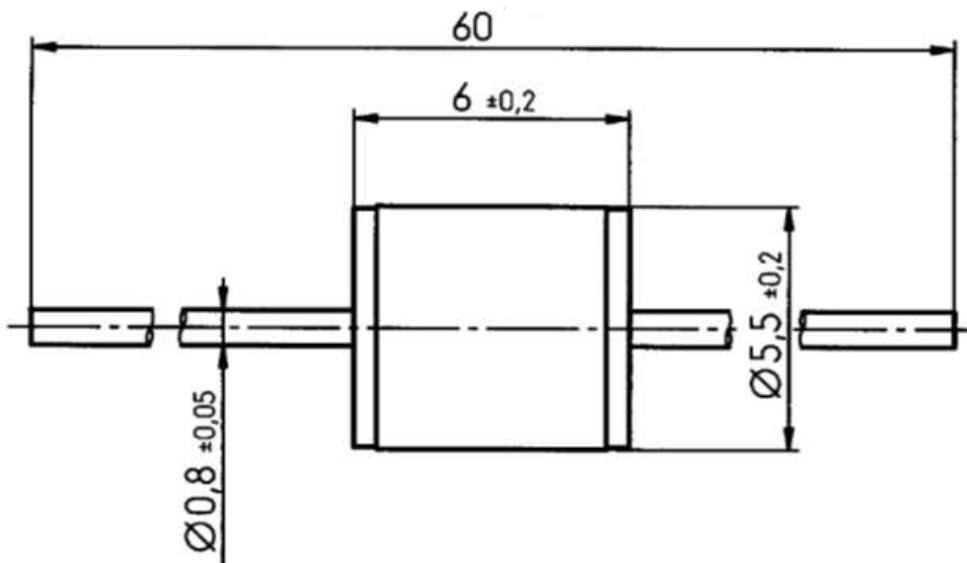

Wire Tin-plated

Packaging

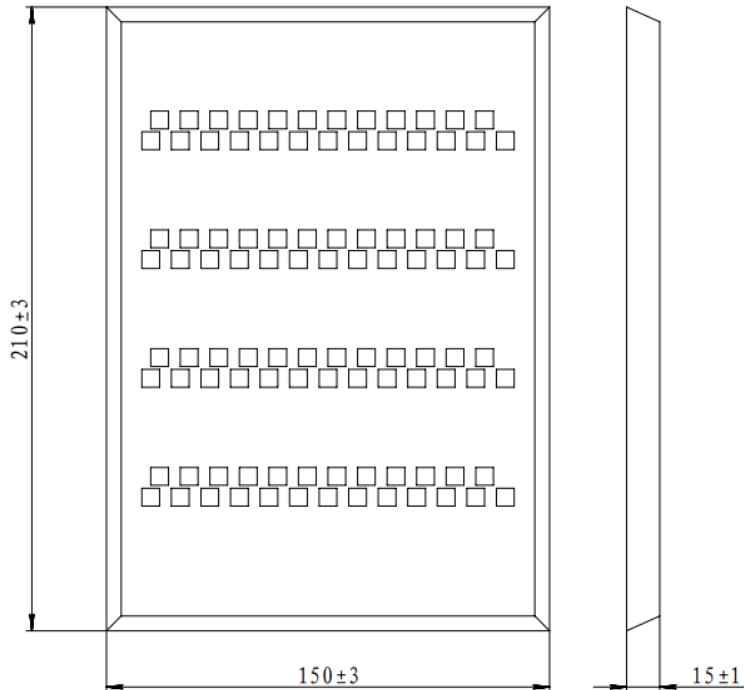

100pcs/box

Cautions and warnings

- Surge arresters must not be operated directly in power supply networks
- Surge arresters may become hot in case of longer periods of current stress (danger of burning).
- If the contacts of the surge arrester are defective, current stress can lead to the formation of sparks and loud noises.
- Surge arresters may be used only within their specified values. In case of overload, the head contacts may fail or the component may be destroyed.
- Damaged surge arresters must not be re-used.

DC Elec.

Issue 03/2015-07-19