

编号	修改原因	制图	审核	核准

•材质&电镀
 螺母: M2.5, 黄铜
 焊针: 黄铜, 镀锡
 塑件: PA66, UL94V-0
•电气性能
 参考标准 UL IEC
 额定电压: 300V 450V
 额定电流: 15A 20A
 接触电阻: 20MΩ
 绝缘电阻: 500MΩ /DC500V
 耐电压: AC2000V/1min
•机械性能
 温度范围: -40°C ~ +105°C
 瞬时温度: +250°C for 5 Sec

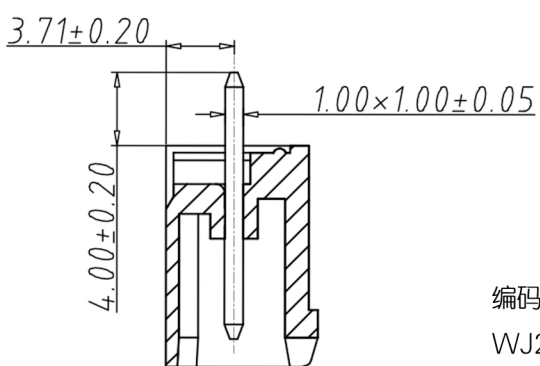
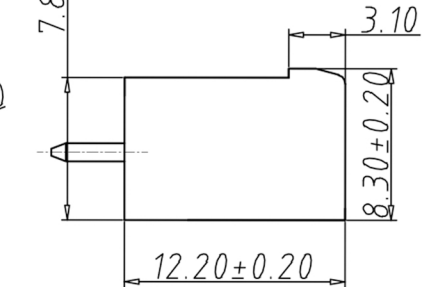

SECTION A-A

编码原则:

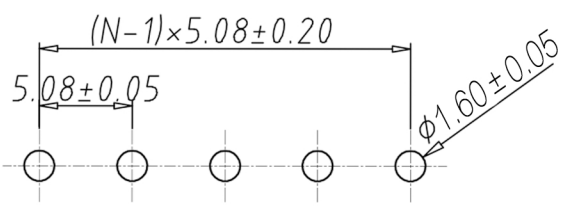
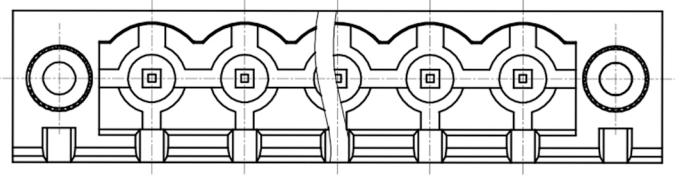
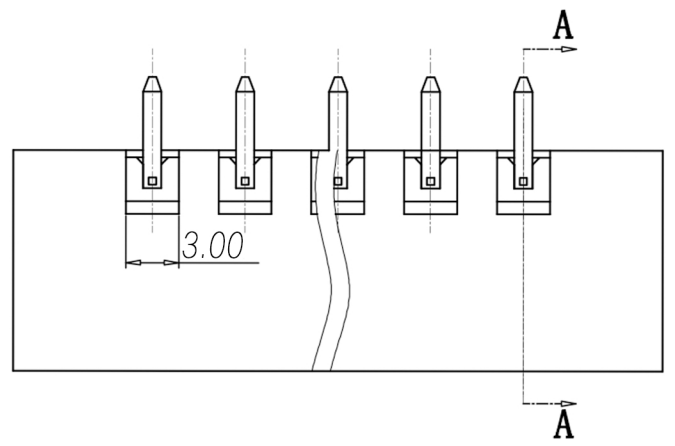
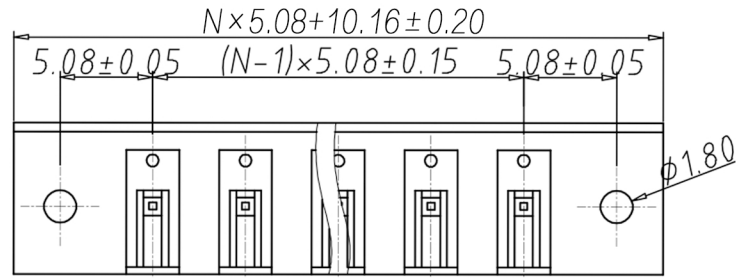
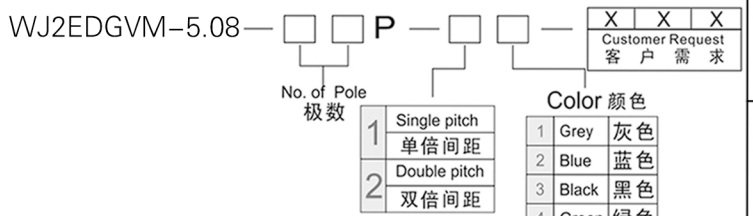

P.C.B.LAYOUT

尺寸公差:		角度公差:	
X.	±0.20	X.	±2'
.X	±0.15	.X	±1.5'
.XX	±0.10	.XX	±1'
图纸类型	客户图纸		
比例	1:1	图页	1\1
图纸编号			

投影法		品名	嵌式接线端子
单位	mm	间距5.08MM	
纸张尺寸	A4	产品系列	WJ2EDGVM 系列

宁波康奈克斯电气有限公司
 Ningbo Kangnex Electric Co., Ltd