

MODEL	CODE NO.	STEM COLOR	CASE COLOR	O/FORCE	LIFE CYCLES
JT1143HJ		BROWN	BROWN	130±30gf	50,000
JT1143J		BLACK		180±50gf	40,000
JT1143WJ		NATURAL		260±50gf	30,000

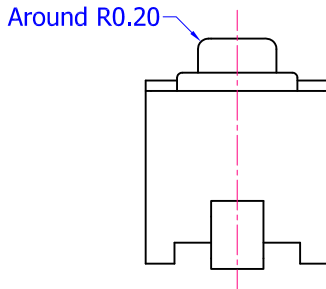

CIRCUIT DIAGRAM

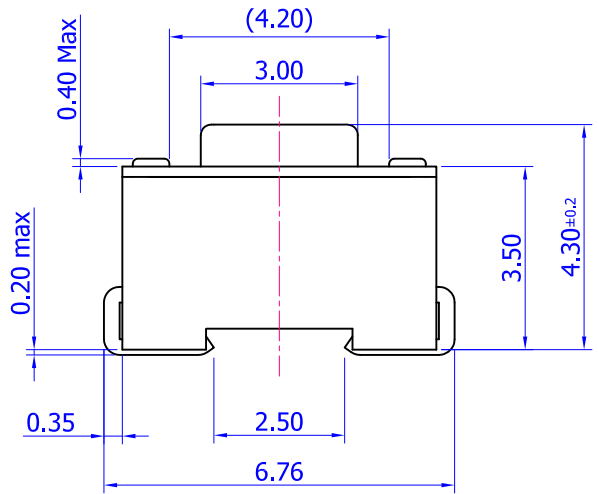
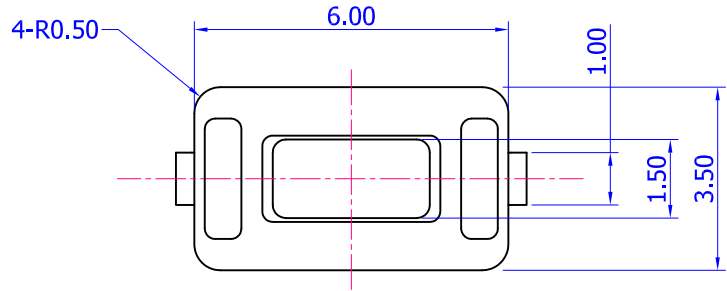
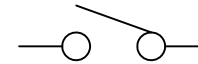

**NOTE**

- TRAVEL :  $0.25^{+0.2}_{-0.1}$  mm
- CONTACT RESISTANCE : 100mΩ Max
- GENERAL TOLERANCE : ±0.3
- MANUFACTURING SPECIFICATION WOULD BE ACCORDANCE WITH WT0158

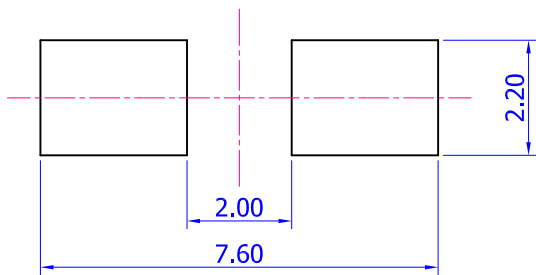

P.C.B LAND DIMENSION

Designed by Hao.Z.T				
Checked by		Unit mm	Scale 1/1	Date 2019.02.01
Approved by	Item TACTILE SWITCH	Tool A	Sheet 1/1	Rev. 0
Model JT1143J Series	Drawing name ASS'Y DRAWING			

	SPECIFICATION	PAGE
	TACT SWITCH	1 / 4

1. GENERAL MATTERS

1.1 Application : This specification is applied to low current circuit tactile switch for electronic equipment.

1.2 Operating temperature range : -20 ~ 70°C, 45 ~ 85% RH

1.3 Storage temperature range : -30 ~ 80°C. However, 96 hours maximum for continuous storage over a range -20 ~ -30°C and a range 70 ~ 80°C.

1.4 Test conditions : The standard test conditions shall be 5 ~ 35°C in temperature, 45 ~ 85% RH and 860 ~ 1060mbar in atmospheric pressure.

Should any doubt arise in judgement, tests shall be conducted at 20±2°C, 65±5% RH and 860 ~ 1060mbar.

2. RATED VOLTAGE AND CURRENT.

DC 12V 50mA

3. ELECTRICAL PERFORMANCE

	PROPERTY	TEST CONDITIONS	PERFORMANCE
3.1	Contact arrangement		* 1 pole, 1 throw.
3.2	Contact resistance	Measured at DC 5V 10mA or by ohmmeter allowing a small current at 1KHz with a load of 150% of the actuating force.	*As per individual manufactured drawing.
3.3	Insulation resistance	DC 100V is applied between terminals and between terminals and earth for 1minute ±5seconds.	* greater than 100 MΩ.
3.4	Dielectric strength	AC 250V (50 ~ 60Hz) is applied between terminals and between terminals and earth for 1 minute.	* No insulation defect shall be observed.
3.5	Bounce	Measured by lightly striking the center of the button stem at a rate of 3 operations/sec...	* less than 10 msec.

						APPD	CHKD	DSGN	TITLE
									DOCUMENT NO.
									WT 0158
ZONE	SYMB	DATE	APPD	CHKD	DSGD				

	SPECIFICATION	PAGE
	TACT SWITCH	2 / 4

#### 4. MECHANICAL PERFORMANCE

	PROPERTY	TEST CONDITIONS	PERFORMANCE
4.1	Actuating force	A gradually increasing load is applied to the center of the button stem.	* As per individual manufactured drawing.
4.2	Return force	After actuating, the load is gradually decreased until the stem returns to its free position.	* 160gf, 260gf : greater than 50gf. * 100gf, 130gf : greater than 30gf.
4.3	Stop strength	A static force of 3 Kgf shall be applied to the direction of operation for 3 seconds.	* Shall be free from mechanical and electrical abnormalities.
4.4	Stem withdrawal force	A static load of 500gf is applied to the direction of pulling for 3 seconds.	* Shall be free from mechanical and electrical degradation.
4.5	Travel		* As per individual manufactured drawing.
4.6	Arrangement of action		* Tactile feed-back.

#### 5. DURABILITY

	PROPERTY	TEST CONDITIONS	PERFORMANCE
5.1	Operating life	The test is conducted according to the below. (1) DC12V 50mA resistive load (2) Rate of operation : 120 cycle/min (3) Actuating force : 150% of actuating force (4) Operating cycle : As per individual manufactured drawing.	* Contact resistance : 200mΩ max. * Bounce : 20m sec max. * Actuating force : within ± 30% of the initial value.

						APPD	CHKD	DSGN	TITLE
									DOCUMENT NO.
									WT 0158
ZONE	SYMB	DATE	APPD	CHKD	DSGD				

	SPECIFICATION	PAGE
	TACT SWITCH	3 / 4

6. WEATHER PROOF

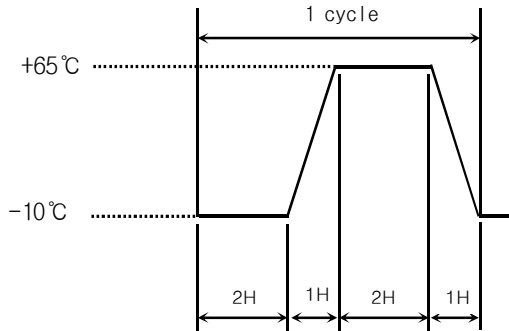
	PROPERTY	TEST CONDITIONS	PERFORMANCE
6.1	Cold heat proof	After testing at $-30^{\circ}\text{C}$ for 96hours. the sample is allowed to stand under normal temperature and humidity conditions for 1hour and measurement is performed within 1hour after that. Water drops should be wiped off.	* The requirement in item 3 and 4 shall be satisfied.
6.2	Dry heat proof	After testing at $85^{\circ}\text{C}$ for 96hours. the sample is allowed to stand under normal temperature for 1hour and measurement is performed within 1 hour after that.	* The requirement in item 3 and 4 shall be satisfied.
6.3	Damp heat proof	After testing at $60\pm 2^{\circ}\text{C}$ and 90 ~ 95% in relative humidity for 96hours, the sample is allowed to stand under normal temperature and humidity conditions for 1hour and measurement is performed within 1hour after that. Water drops should be wiped off.	* Insulation resistance : $10\text{M}\Omega$ minimum. * Dielectric strength : same as item 3.4. * Contact resistance : same as item 3.2.
6.4	Thermal cycling	 <p>After the test conducted under 5 cycles the sample is allowed to stand under normal temperature and humidity conditions for 1 hour, and the measurement is performed within 1 hour.</p>	* The requirement in item 3 and 4 shall be met.

						APPD	CHKD	DSGN	TITLE
									DOCUMENT NO.
									WT 0158
ZONE	SYMB	DATE	APPD	CHKD	DSGD				

	SPECIFICATION	PAGE
	TACT SWITCH	4 / 4

7. REFLOW SOLDERING

7.1 Reflow soldering conditions

- 1) Preheat ----- 150°C ~ 200°C, 120 ±20 (sec)
- 2) Peak temperature --- 260°C max. 10 (sec)
- 3) Soldering area temperature ----- 217°C, 90 ~ 120 (sec)

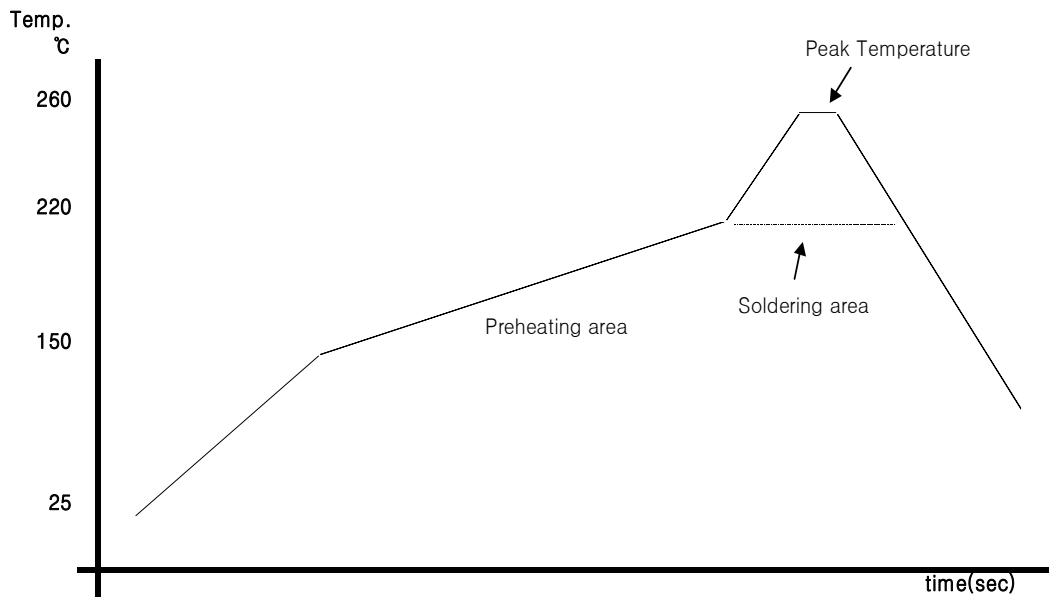

< Temperature profile >

8. Manual soldering

- 8.1 Soldering temperature ----- 350°C ±5°C
- 8.2 Soldering time ----- 5(sec)

						APPD	CHKD	DSGN	TITLE
									DOCUMENT NO.
ZONE	SYMB	DATE	APPD	CHKD	DSGD				WT 0158