

High Performance Schottky Rectifier, 19 A

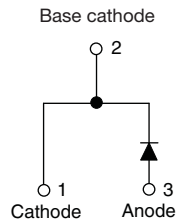

FEATURES

- 125 °C T_J operation ($V_R < 5$ V)
- Optimized for OR-ing applications
- Ultralow forward voltage drop
- High frequency operation
- Guard ring for enhanced ruggedness and long term reliability
- High purity, high temperature epoxy encapsulation for enhanced mechanical strength and moisture resistance
- Designed and qualified according to JEDEC®-JESD 47
- Material categorization: for definitions of compliance please see www.vishay.com/doc?99912



RoHS
COMPLIANT
HALOGEN
FREE

| PRIMARY CHARACTERISTICS | |
|-------------------------|------------------|
| $I_{F(AV)}$ | 19 A |
| V_R | 15 V |
| V_F at I_F | 0.32 V |
| I_{RM} max. | 522 mA at 100 °C |
| T_J max. | 125 °C |
| E_{AS} | 6.75 mJ |
| Package | 2L TO-220AC |
| Circuit configuration | Single |

DESCRIPTION

The VS-19TQ015... Schottky rectifier has been optimized for ultralow forward voltage drop specifically for the OR-ing of parallel power supplies. The proprietary barrier technology allows for reliable operation up to 125 °C junction temperature. Typical applications are in parallel switching power supplies, converters, reverse battery protection, and redundant power subsystems.

| MAJOR RATINGS AND CHARACTERISTICS | | | |
|-----------------------------------|------------------------------------|-------------|-------|
| SYMBOL | CHARACTERISTICS | VALUES | UNITS |
| $I_{F(AV)}$ | Rectangular waveform | 19 | A |
| V_{RRM} | | 15 | V |
| I_{FSM} | $t_p = 5 \mu s$ sine | 700 | A |
| V_F | 19 A _{pk} , $T_J = 75$ °C | 0.32 | V |
| T_J | Range | -55 to +125 | °C |

| VOLTAGE RATINGS | | | |
|--------------------------------------|-----------|---------------|-------|
| PARAMETER | SYMBOL | VS-19TQ015-M3 | UNITS |
| Maximum DC reverse voltage | V_R | 15 | V |
| Maximum working peak reverse voltage | V_{RWM} | | |

| ABSOLUTE MAXIMUM RATINGS | | | | | |
|--|-------------|---|---|--------|-------|
| PARAMETER | SYMBOL | TEST CONDITIONS | | VALUES | UNITS |
| Maximum average forward current See fig. 5 | $I_{F(AV)}$ | 50 % duty cycle at $T_C = 80$ °C, rectangular waveform | | 19 | A |
| Maximum peak one cycle non-repetitive surge current See fig. 7 | I_{FSM} | 5 μs sine or 3 μs rect. pulse | Following any rated load condition and with rated V_{RRM} applied | 700 | |
| | | 10 ms sine or 6 ms rect. pulse | | 330 | |
| Non-repetitive avalanche energy | E_{AS} | $T_J = 25$ °C, $I_{AS} = 1.50$ A, $L = 6$ mH | | 6.75 | mJ |
| Repetitive avalanche current | I_{AR} | Current decaying linearly to zero in 1 μs Frequency limited by T_J maximum $V_A = 3 \times V_R$ typical | | 1.50 | A |



| ELECTRICAL SPECIFICATIONS | | | | | |
|---|----------------|---|----------------------------------|--------|------------------|
| PARAMETER | SYMBOL | TEST CONDITIONS | | VALUES | UNITS |
| Maximum forward voltage drop See fig. 1 | $V_{FM}^{(1)}$ | 19 A | $T_J = 25\text{ }^\circ\text{C}$ | 0.36 | V |
| | | 38 A | | 0.46 | |
| | | 19 A | $T_J = 75\text{ }^\circ\text{C}$ | 0.32 | |
| | | 38 A | | 0.43 | |
| Maximum reverse leakage current See fig. 2 | $I_{RM}^{(1)}$ | $T_J = 100\text{ }^\circ\text{C}, V_R = 12\text{ V}$ | | 465 | mA |
| | | $T_J = 100\text{ }^\circ\text{C}, V_R = 5\text{ V}$ | | 285 | |
| | | $T_J = 25\text{ }^\circ\text{C}$ | $V_R = \text{Rated } V_R$ | 10.5 | |
| | | $T_J = 100\text{ }^\circ\text{C}$ | | 522 | |
| Maximum junction capacitance | C_T | $V_R = 5\text{ V}_{DC}$ (test signal range 100 kHz to 1 MHz) $25\text{ }^\circ\text{C}$ | | 2000 | pF |
| Typical series inductance | L_S | Measured lead to lead 5 mm from package body | | 8.0 | nH |
| Maximum voltage rate of change | dV/dt | Rated V_R | | 10 000 | V/ μs |

Note(1) Pulse width < 300 μs , duty cycle < 2 %

| THERMAL - MECHANICAL SPECIFICATIONS | | | | | |
|---|--------------------|--------------------------------------|--|------------|------------------------|
| PARAMETER | SYMBOL | TEST CONDITIONS | | VALUES | UNITS |
| Maximum junction temperature range | T_J | | | -55 to 125 | $^\circ\text{C}$ |
| Maximum storage temperature range | T_{Stg} | | | -55 to 150 | |
| Maximum thermal resistance, junction to case | R_{thJC} | DC operation See fig. 4 | | 1.50 | $^\circ\text{C/W}$ |
| Typical thermal resistance, case to heatsink | R_{thCS} | Mounting surface, smooth and greased | | 0.50 | |
| Approximate weight | | | | 2 | g |
| | | | | 0.07 | oz. |
| Mounting torque | minimum maximum | | | 6 (5) | kgf · cm (lbf · in) |
| | | | | 12 (10) | |
| Marking device | | Case style 2L TO-220AC | | 19TQ015 | |

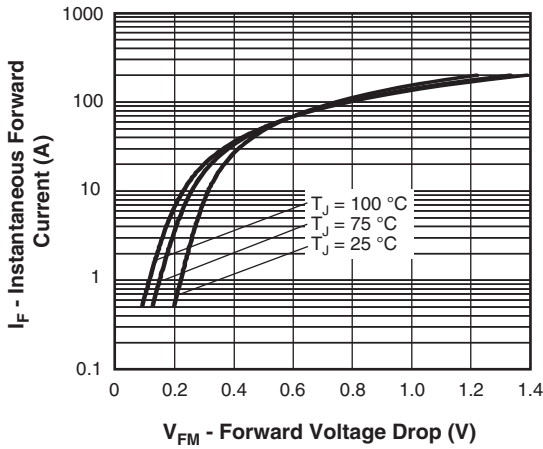

Fig. 1 - Maximum Forward Voltage Drop Characteristics

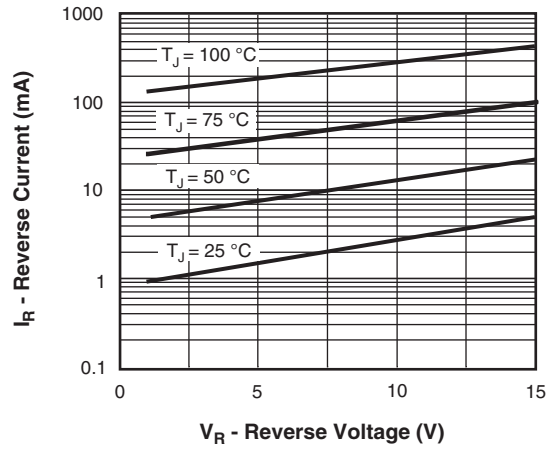

Fig. 2 - Typical Values of Reverse Current vs. Reverse Voltage

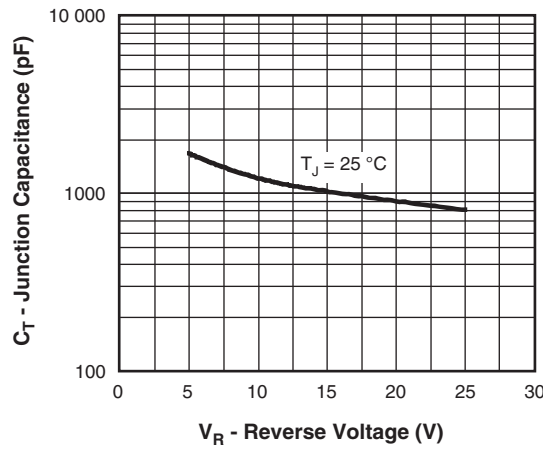

Fig. 3 - Typical Junction Capacitance vs. Reverse Voltage

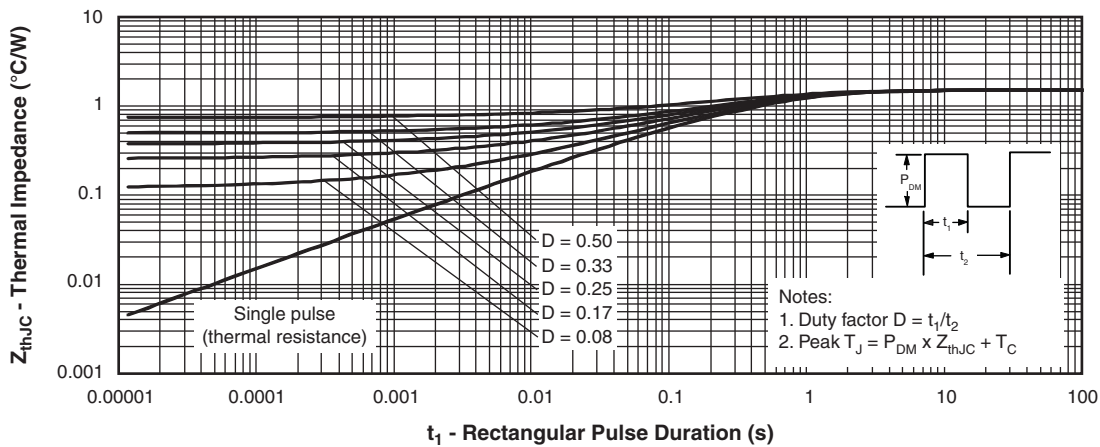

Fig. 4 - Maximum Thermal Impedance Z_{thJC} Characteristics

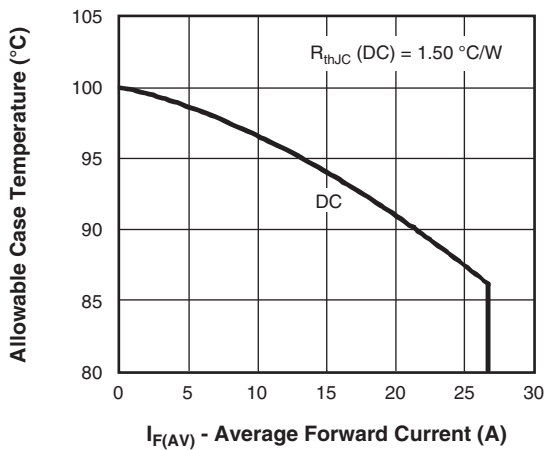

Fig. 5 - Maximum Allowable Case Temperature vs. Average Forward Current

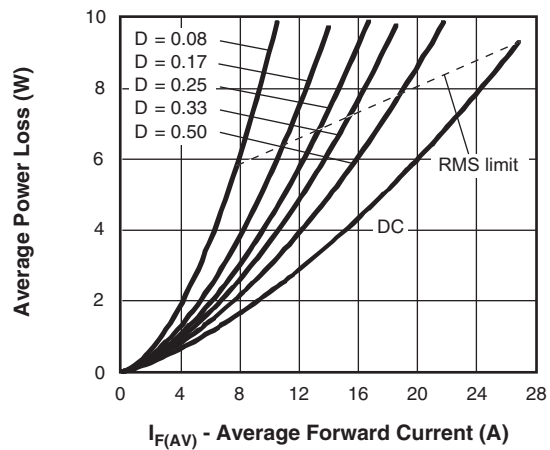

Fig. 6 - Forward Power Loss Characteristics

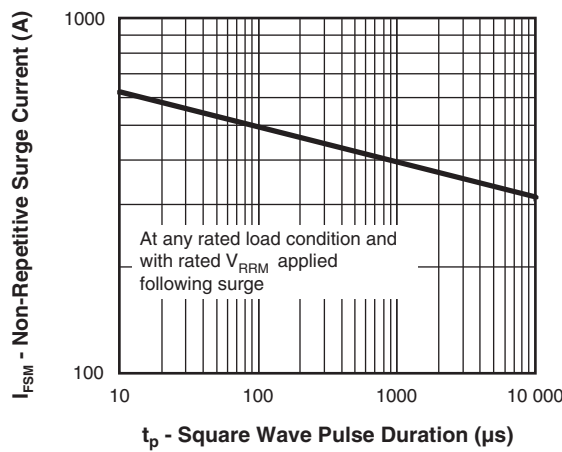

Fig. 7 - Maximum Non-Repetitive Surge Current

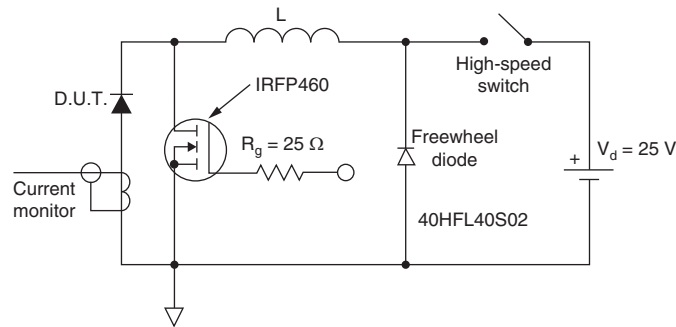
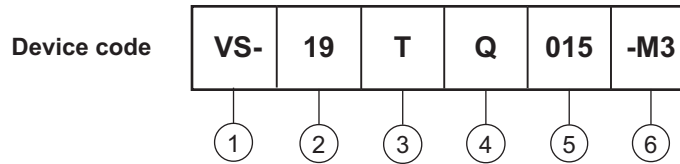

Fig. 8 - Unclamped Inductive Test Circuit



ORDERING INFORMATION TABLE



- 1** - Vishay Semiconductors product
- 2** - Current rating (19 = 19 A)
- 3** - Package:
T = TO-220
- 4** - Schottky "Q" series
- 5** - Voltage rating (015 = 15 V)
- 6** - Environmental digit
-M3 = halogen-free, RoHS-compliant, and totally lead (Pb)-free

| ORDERING INFORMATION (Example) | | | |
|--------------------------------|------------------|------------------------|-------------------------|
| PREFERRED P/N | QUANTITY PER T/R | MINIMUM ORDER QUANTITY | PACKAGING DESCRIPTION |
| VS-19TQ015-M3 | 50 | 1000 | Antistatic plastic tube |

| LINKS TO RELATED DOCUMENTS | |
|----------------------------|--|
| Dimensions | www.vishay.com/doc?96156 |
| Part marking information | www.vishay.com/doc?95391 |
| SPICE model | www.vishay.com/doc?96005 |



2L TO-220AC

DIMENSIONS in millimeters and inches

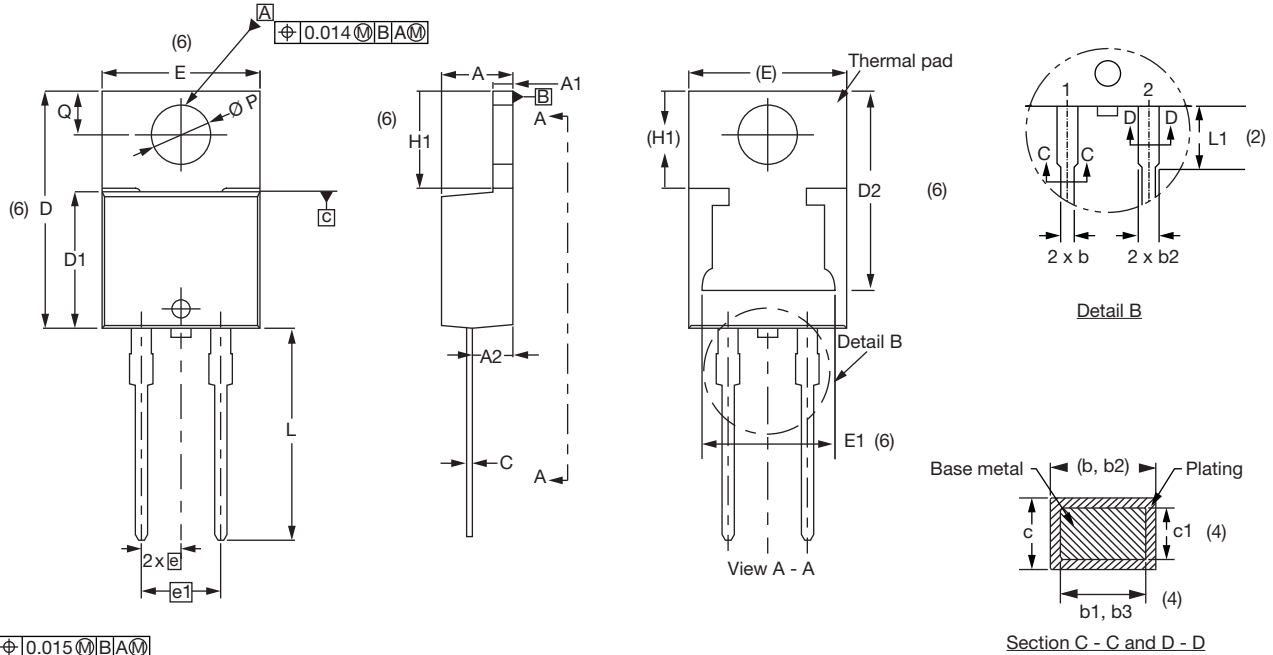

Conforms to JEDEC® outline TO-220AC

| SYMBOL | MILLIMETERS | | INCHES | | NOTES | SYMBOL | MILLIMETERS | | INCHES | | NOTES |
|--------|-------------|-------|--------|-------|-------|-----------------|-------------|-------|--------|-------|-------|
| | MIN. | MAX. | MIN. | MAX. | | | MIN. | MAX. | MIN. | MAX. | |
| A | 4.25 | 4.65 | 0.167 | 0.183 | | D2 | 11.68 | 13.30 | 0.460 | 0.524 | 6, 7 |
| A1 | 1.14 | 1.40 | 0.045 | 0.055 | | E | 10.11 | 10.51 | 0.398 | 0.414 | 3, 6 |
| A2 | 2.50 | 2.92 | 0.098 | 0.115 | | E1 | 6.86 | 8.89 | 0.270 | 0.350 | 6 |
| b | 0.69 | 1.01 | 0.027 | 0.040 | | e | 2.41 | 2.67 | 0.095 | 0.105 | |
| b1 | 0.38 | 0.97 | 0.015 | 0.038 | 4 | e1 | 4.88 | 5.28 | 0.192 | 0.208 | |
| b2 | 1.20 | 1.73 | 0.047 | 0.068 | | H1 | 6.09 | 6.48 | 0.240 | 0.255 | 6 |
| b3 | 1.14 | 1.73 | 0.045 | 0.068 | 4 | L | 13.52 | 14.02 | 0.532 | 0.552 | |
| c | 0.36 | 0.61 | 0.014 | 0.024 | | L1 | 3.32 | 3.82 | 0.131 | 0.150 | 2 |
| c1 | 0.36 | 0.56 | 0.014 | 0.022 | 4 | $\varnothing P$ | 3.54 | 3.91 | 0.139 | 0.154 | |
| D | 14.85 | 15.35 | 0.585 | 0.604 | 3 | Q | 2.60 | 3.00 | 0.102 | 0.118 | |
| D1 | 8.38 | 9.02 | 0.330 | 0.355 | | | | | | | |

Notes

- (1) Dimensioning and tolerancing as per ASME Y14.5M-1994
- (2) Lead dimension and finish uncontrolled in L1
- (3) Dimension D, D1, and E do not include mold flash. Mold flash shall not exceed 0.127 mm (0.005") per side. These dimensions are measured at the outermost extremes of the plastic body
- (4) Dimension b1, b3, and c1 apply to base metal only
- (5) Controlling dimensions: inches
- (6) Thermal pad contour optional within dimensions E, H1, D2, and E1
- (7) Outline conforms to JEDEC® TO-220, except D2



Disclaimer

ALL PRODUCT, PRODUCT SPECIFICATIONS AND DATA ARE SUBJECT TO CHANGE WITHOUT NOTICE TO IMPROVE RELIABILITY, FUNCTION OR DESIGN OR OTHERWISE.

Vishay Intertechnology, Inc., its affiliates, agents, and employees, and all persons acting on its or their behalf (collectively, "Vishay"), disclaim any and all liability for any errors, inaccuracies or incompleteness contained in any datasheet or in any other disclosure relating to any product.

Vishay makes no warranty, representation or guarantee regarding the suitability of the products for any particular purpose or the continuing production of any product. To the maximum extent permitted by applicable law, Vishay disclaims (i) any and all liability arising out of the application or use of any product, (ii) any and all liability, including without limitation special, consequential or incidental damages, and (iii) any and all implied warranties, including warranties of fitness for particular purpose, non-infringement and merchantability.

Statements regarding the suitability of products for certain types of applications are based on Vishay's knowledge of typical requirements that are often placed on Vishay products in generic applications. Such statements are not binding statements about the suitability of products for a particular application. It is the customer's responsibility to validate that a particular product with the properties described in the product specification is suitable for use in a particular application. Parameters provided in datasheets and / or specifications may vary in different applications and performance may vary over time. All operating parameters, including typical parameters, must be validated for each customer application by the customer's technical experts. Product specifications do not expand or otherwise modify Vishay's terms and conditions of purchase, including but not limited to the warranty expressed therein.

Except as expressly indicated in writing, Vishay products are not designed for use in medical, life-saving, or life-sustaining applications or for any other application in which the failure of the Vishay product could result in personal injury or death. Customers using or selling Vishay products not expressly indicated for use in such applications do so at their own risk. Please contact authorized Vishay personnel to obtain written terms and conditions regarding products designed for such applications.

No license, express or implied, by estoppel or otherwise, to any intellectual property rights is granted by this document or by any conduct of Vishay. Product names and markings noted herein may be trademarks of their respective owners.