

# TPS23881 Type-4 4-Pair 8-Channel PoE PSE Controller with SRAM and 200 mΩ R<sub>SENSE</sub>

## 1 Features

- IEEE 802.3bt PSE solution for Type 3 or Type 4 Power Over Ethernet applications
- Eight independent PSE channels
- Resistor selectable Autonomous operation
  - No external MCU required
- Compatible with TI's *FirmPSE* system firmware
- *SRAM Programmable memory*
- Programmable power limiting accuracy  $\pm 2.5\%$
- 200-mΩ Current sense resistor
- Legacy PD capacitance measurement
- Selectable 2-pair or 4-pair port power allocations
  - 15.4 W, 30 W, 45 W, 60 W, 75 W or 90 W
- Single and dual signature PD compatibility
- Dedicated 14-bit integrating current ADC per port
  - Noise immune MPS for DC disconnect
  - 2% Current sensing accuracy
- 1- or 3-Bit fast port shutdown input
- Auto-class discovery and power measurement
- Inrush and operational foldback protection
- Flexible processor controlled operating modes
  - Auto, semi auto and manual / diagnostic
- Per Port voltage monitoring and telemetry
- $-40^{\circ}\text{C}$  to  $+125^{\circ}\text{C}$  Temperature operation
- [Ultra Low Alpha \(ULA\)](#) packaging (TPS23881A)

## 2 Applications

- [Video recorder \(NVR, DVR, and so forth\)](#)
- [Small business switch](#)
- [Campus and branch switches](#)

## 3 Description

The TPS23881 is an 8-channel power sourcing equipment (PSE) controller engineered to insert power onto Ethernet cables in accordance with the IEEE 802.3bt standard. The eight individual power channels can be configured in any combination of 2-Pair (1-channel) or 4-Pair (2-channels) PoE Ports. The PSE controller can detect powered devices (PDs) that have a valid signature, determine the power requirements of the devices according to their classification, and apply power.

The TPS23881 improves on the TPS23880 with reduced current sense resistors, more accurate programmable power limiting, capacitance measurement and the ability to operate from ROM (see [Device Comparison Table](#)). The TPS23881 is also compatible with TI's *FirmPSE* system firmware, which provides a fully configurable solution for controlling multiple TPS23881 devices in systems offering up to 48-ports of 4-pair PoE power.

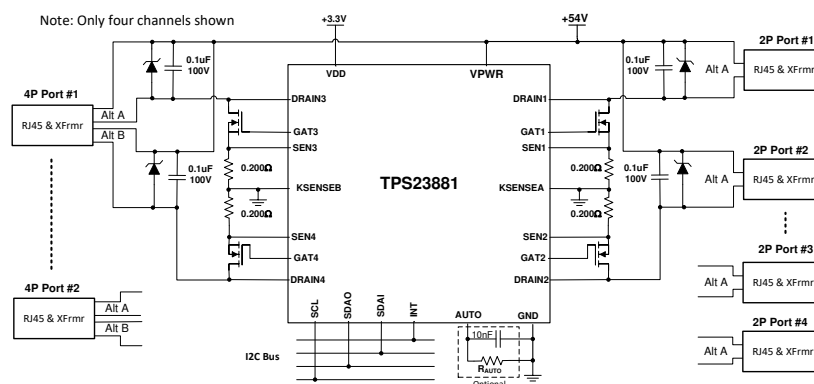
Dedicated per port ADCs provide continuous port current monitoring and the ability to perform parallel classification measurements for faster port turn on times. A  $\pm 2.5\%$  accurate programmable port power limit provides the ability to expand the maximum power sourced from 90 W to upwards of 125 W. The 200-mΩ current sense resistor and external FET architecture allow designs to balance size, efficiency, thermal and solution cost requirements.

### Device Information<sup>(1)</sup>

PART NUMBER	PACKAGE	BODY SIZE (NOM)
TPS23881	VQFN (56)	8.00 mm x 8.00 mm

(1) For all available packages, see the orderable addendum at the end of the data sheet.

### Simplified Schematic



## Table of Contents

<b>1 Features</b> .....	<b>1</b>	9.5 I <sup>2</sup> C Programming .....	<b>32</b>
<b>2 Applications</b> .....	<b>1</b>	9.6 Register Maps .....	<b>35</b>
<b>3 Description</b> .....	<b>1</b>	<b>10 Application and Implementation</b> .....	<b>112</b>
<b>4 Revision History</b> .....	<b>2</b>	10.1 Application Information .....	<b>112</b>
<b>5 Device Comparison Table</b> .....	<b>3</b>	10.2 Typical Application .....	<b>114</b>
<b>6 Pin Configuration and Functions</b> .....	<b>4</b>	<b>11 Power Supply Recommendations</b> .....	<b>123</b>
6.1 Detailed Pin Description .....	5	11.1 VDD .....	123
<b>7 Specifications</b> .....	<b>7</b>	11.2 VPWR .....	123
7.1 Absolute Maximum Ratings .....	7	<b>12 Layout</b> .....	<b>124</b>
7.2 ESD Ratings .....	7	12.1 Layout Guidelines .....	124
7.3 Recommended Operating Conditions .....	7	12.2 Layout Example .....	125
7.4 Thermal Information .....	7	<b>13 Device and Documentation Support</b> .....	<b>126</b>
7.5 Electrical Characteristics .....	8	13.1 Documentation Support .....	126
7.6 Typical Characteristics .....	14	13.2 Receiving Notification of Documentation Updates .....	126
<b>8 Parameter Measurement Information</b> .....	<b>19</b>	13.3 Support Resources .....	126
8.1 Timing Diagrams .....	19	13.4 Trademarks .....	126
<b>9 Detailed Description</b> .....	<b>23</b>	13.5 Electrostatic Discharge Caution .....	126
9.1 Overview .....	23	13.6 Glossary .....	126
9.2 Functional Block Diagram .....	27	<b>14 Mechanical, Packaging, and Orderable Information</b> .....	<b>126</b>
9.3 Feature Description .....	28		
9.4 Device Functional Modes .....	30		

## 4 Revision History

<b>Changes from Revision B (August 2019) to Revision C</b>	<b>Page</b>
• Added TPS23882 to the <a href="#">Device Comparison Table</a> .....	<b>3</b>

---

<b>Changes from Revision A (May 2019) to Revision B</b>	<b>Page</b>
• Changed from Advance Information to Production Data .....	<b>1</b>

---

<b>Changes from Original (March 2019) to Revision A</b>	<b>Page</b>
• First public release of the Advance Information data sheet .....	<b>1</b>

---

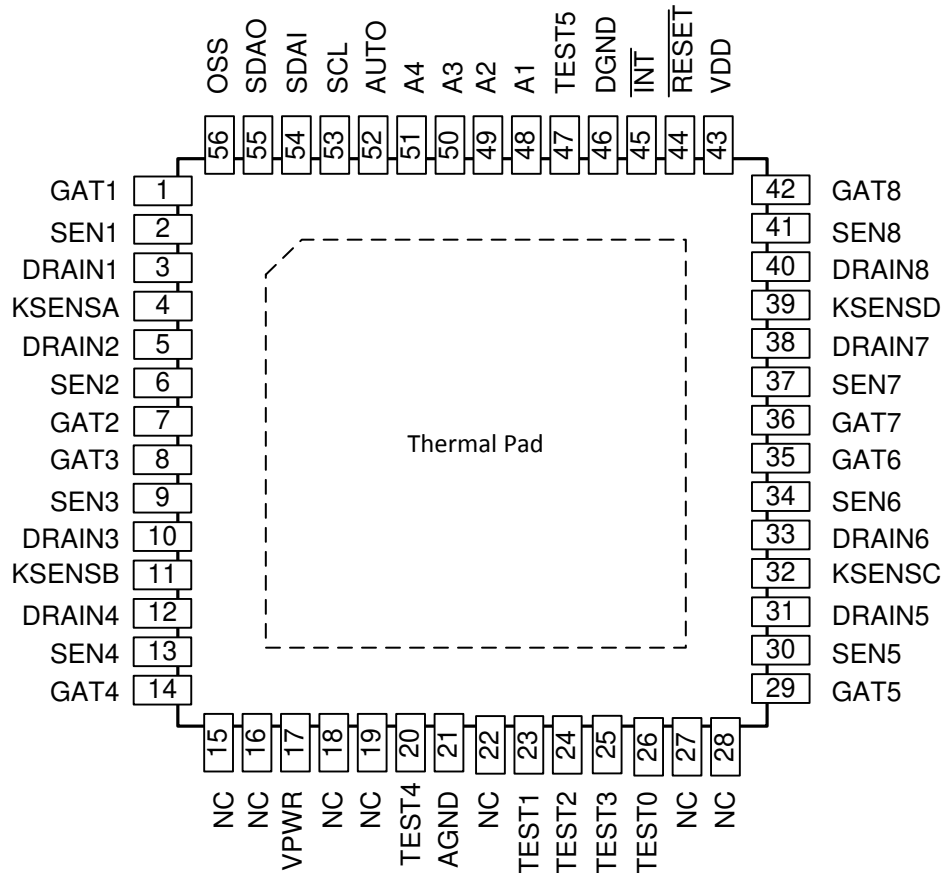
<b>Changes from Revision C (July 2019) to Revision D</b>	<b>Page</b>
--	-------------

## 5 Device Comparison Table

KEY FEATURES	TPS23880	TPS23881	TPS23882
Compatible with TI's <i>FirmPSE</i> system firmware	N/A	Yes	Yes
Pin to Pin compatible	Yes	Yes	Yes
Number of PSE Channels	8	8	8
Supported IEEE 802.3 PSE Types	802.3bt Type 3 or 4 (2 or 4 Pair)	802.3bt Type 3 or 4 (2 or 4 Pair)	802.3bt Type 3 (2-Pair)
R <sub>SENSE</sub>	0.255 Ω	0.200 Ω	0.200 Ω
Autonomous operation Resistor Selectable	N/A	Yes 2-Pair: 15.5 W or 30W 4-Pair: 30 W up to 90W	Yes 2-Pair: 15.5 W or 30 W
2-Pair P <sub>CUT</sub> programable ranges	0.5 W to 54 W	2 W to 65 W	2 W to 65 W
4-Pair P <sub>CUT</sub> programable ranges	0.5 W to 108 W	4 W to 127 W	N/A
90+ W 4-pair P <sub>CUT</sub> accuracy	±3.0 %	±2.5 %	N/A
Channel capacitance measurement range	N/A	1 μF to 12 μF	1 μF to 12 μF
ULA Packaging	No	Yes (TPS23881A)	N/A
I <sup>2</sup> C Programmable SRAM Memory	16 kB	16 kB	16 kB

## 6 Pin Configuration and Functions

RTQ Package With Exposed Thermal Pad  
56-Pin VQFN  
Top View



### Pin Functions

PIN		I/O	DESCRIPTION
NAME	NO.		
A1-4	48–51	I	I <sup>2</sup> C A1-A4 address lines. These pins are internally pulled up to VDD.
AGND	21	—	Analog ground. Connect to GND plane and exposed thermal pad.
DGND	46	—	Digital ground. Connect to GND plane and exposed thermal pad.
DRAIN1-8	3, 5, 10, 12, 31, 33, 38, 40	I	Channel 1-8 output voltage monitor.
GAT1-8	1, 7, 8, 14, 29, 35, 36, 42	O	Channel 1-8 gate drive output.
$\overline{\text{INT}}$	45	O	Interrupt output. This pin asserts low when a bit in the interrupt register is asserted. This output is open-drain.
KSENSA/B	4, 11	I	Kelvin point connection for SEN1-4
KSENSC/D	32, 39	I	Kelvin point connection for SEN5-8
NC	15, 16, 18, 19	O	No connect pins. These pins are internally biased at 1/3 and 2/3 of VPWR in order to control the voltage gradient from VPWR. Leave open.
	22, 27, 28, 52	—	No connect pin. Leave open.
OSS	56	I	Channel 1-8 fast shutdown. This pin is internally pulled down to DGND.
$\overline{\text{RESET}}$	44	I	Reset input. When asserted low, the TPS23881 is reset. This pin is internally pulled up to VDD.
SCL	53	I	Serial clock input for I <sup>2</sup> C bus.
SDAI	54	I	Serial data input for I <sup>2</sup> C bus. This pin can be connected to SDAO for non-isolated systems.
SDAO	55	O	Serial data output for I <sup>2</sup> C bus. This pin can be connected to SDAI for non-isolated systems. This output is open-drain.
AUTO	52	I/O	Autonomous mode enable and selection pin.
SEN1-8	2, 6, 9, 13, 30, 34, 37, 41	I	Channel 1-8 current sense input.
TEST0-5	20, 23, 24, 25, 26, 47	I/O	Used internally for test purposes only. Leave open.
Thermal pad	—	—	The DGND and AGND terminals must be connected to the exposed thermal pad for proper operation.
VDD	43	—	Digital supply. Bypass with 0.1 $\mu\text{F}$ to DGND pin.
VPWR	17	—	Analog 54-V positive supply. Bypass with 0.1 $\mu\text{F}$ to AGND pin.

## 6.1 Detailed Pin Description

The following descriptions refer to the pinout and the functional block diagram.

**DRAIN1-DRAIN8:** Channels 1-8 output voltage monitor and detect sense. Used to measure the port output voltage, for port voltage monitoring, port power good detection and foldback action. Detection probe currents also flow into this pin.

The TPS23881 uses an innovative 4-point technique to provide reliable PD detection and avoids powering an invalid load. The discovery is performed by sinking two different current levels via the DRAINn pin, while the PD voltage is measured from VPWR to DRAINn. If prior to starting a new detection cycle the port voltage is >2.5 V, an internal 100-k $\Omega$  resistor is connected in parallel with the port and a 400-ms detect backoff period is applied to allow the port capacitor to be discharged before the detection cycle starts.

There is an internal resistor between each DRAINn pin and VPWR in any operating mode except during detection or while the port is ON. If the port n is not used, DRAINn can be left floating or tied to GND.

**GAT1-GAT8:** Channels 1-8 gate drive outputs are used for external N-channel MOSFET gate control. At port turn on, it is driven positive by a low current source to turn the MOSFET on. GATn is pulled low whenever any of the input supplies are low or if an overcurrent timeout has occurred. GATn is also pulled low if the port is turned off by use of manual shutdown inputs. Leave floating if unused.

For improved design robustness, the current foldback functions limit the power dissipation of the MOSFET during low resistance load or short-circuit events and during the inrush period at port turn on. There is also fast overload protection comparator for major faults like a direct short that forces the MOSFET to turn off in less than a microsecond.

The circuit leakage paths between the GATn pin and any nearby DRAINn pin, GND or Kelvin point connection must be minimized (< 250 nA), to ensure correct MOSFET control.

## Detailed Pin Description (continued)

**INT:** This interrupt output pin asserts low when a bit in the interrupt register is asserted. This output is open-drain.

**KSENSA, KSENSB, KSENSC, KSENSD:** Kelvin point connection used to perform a differential voltage measurement across the associated current sense resistors.

Each KSENS is shared between two neighbor SEN pins as following: KSENSA with SEN1 and SEN2, KSENSB with SEN3 and SEN4, KSENSC with SEN5 and SEN6, KSENSD with SEN7 and SEN8. To optimize the measurement accuracy, ensure proper PCB layout practices are followed.

**OSS:** Fast shutdown, active high. This pin is internally pulled down to DGND, with an internal 1- $\mu$ s to 5- $\mu$ s deglitch filter.

The turn off procedure is similar to a port reset using Reset command (1Ah register). The 3-bit OSS function allows for a series of pulses on the OSS pin to turn off individual or multiple ports with up to 8 levels of priority.

**RESET:** Reset input, active low. When asserted, the TPS23881 resets, turning off all ports and forcing the registers to their power-up state. This pin is internally pulled up to VDD, with internal 1- $\mu$ s to 5- $\mu$ s deglitch filter. The designer can use an external RC network to delay the turn-on. There is also an internal power-on-reset which is independent of the RESET input.

**SCL:** Serial clock input for I<sup>2</sup>C bus.

**SDAI:** Serial data input for I<sup>2</sup>C bus. This pin can be connected to SDAO for non-isolated systems.

**SDAO:** Open-drain I<sup>2</sup>C bus output data line. Requires an external resistive pull-up. The TPS23881 uses separate SDAO and SDAI lines to allow optoisolated I<sup>2</sup>C interface. SDAO can be connected to SDAI for non-isolated systems.

**AUTO: Autonomous** mode selection pin: Floating this pin will disable autonomous operation. Tying this pin to GND through a resistor ( $R_{AUTO}$ ) will enable autonomous operation at selectable port power allocation levels. A 10 nF capacitor is required between the Auto pin and GND if  $R_{AUTO}$  is connected.

**A4-A1:** I<sup>2</sup>C bus address inputs. These pins are internally pulled up to VDD. See [PIN STATUS Register](#) for more details.

**SEN1-8:** Channel current sense input relative to KSENSn (see KSENSn description). A differential measurement is performed using KSENSA-D Kelvin point connection. Monitors the external MOSFET current by use of a 0.200- $\Omega$  current sense resistor connected to GND. Used by current foldback engine and also during classification. Can be used to perform load current monitoring via ADC conversion.

When the TPS23881 performs the classification measurements, the current flows through the external MOSFETs. This avoids heat concentration in the device and makes it possible for the TPS23881 to perform classification measurements on multiple ports at the same time. For the current limit with foldback function, there is an internal 2- $\mu$ S analog filter on the SEN1-8 pins to provide glitch filtering. For measurements through an ADC, an anti-aliasing filter is present on the SEN1-8 pins. This includes the port-powered current monitoring, port policing, and DC disconnect.

If the port is not used, tie SENn to GND.

**VDD:** 3.3-V logic power supply input.

**VPWR:** High voltage power supply input. Nominally 54 V.

**AGND and DGND:** Ground references for internal analog and digital circuitry respectively. Not connected together internally. Both pins require a low resistance path to the system GND plane. If a robust GND plane is used to extract heat from the device's thermal pad, these pins may be connected together through the thermal pad connection on the pcb.

## 7 Specifications

### 7.1 Absolute Maximum Ratings

over operating free-air temperature range (unless otherwise noted)<sup>(1)</sup>

		MIN	MAX	UNIT
Voltage	VPWR	-0.3	70	V
	VDD	-0.3	4	V
	OSS, RESET, A1-A4, AUTO, SDAI, SDAO, SCL, INT	-0.3	4	V
	SEN1-8, KSENSA, KSENSB, KSENSC, KSENSD	-0.3	3	V
	GATE1-8	-0.3	12	V
	DRAIN1-8	-0.3	70	V
	TEST0-3, ATST_DCPL0, DTST_DCPL1	-0.3	4	V
	AGND - DGND	-0.3	0.3	V
Sink Current	INT, SDA		20	mA
Lead Temperature 1/6mm from case for 10 seconds			260	°C
T <sub>stg</sub>	Storage temperature	-65	150	°C

(1) Stresses beyond those listed under *Absolute Maximum Rating* may cause permanent damage to the device. These are stress ratings only, which do not imply functional operation of the device at these or any other conditions beyond those indicated under *Recommended Operating Condition*. Exposure to absolute-maximum-rated conditions for extended periods may affect device reliability.

### 7.2 ESD Ratings

			VALUE	UNIT
V <sub>(ESD)</sub>	Electrostatic discharge	Human body model (HBM), per ANSI/ESDA/JEDEC JS-001, all pins <sup>(1)</sup>	±2000	V
		Charged device model (CDM), per JEDEC specification JESD22-C101, all pins <sup>(2)</sup>	± 500	

(1) JEDEC document JEP155 states that 500-V HBM allows safe manufacturing with a standard ESD control process.

(2) JEDEC document JEP157 states that 250-V CDM allows safe manufacturing with a standard ESD control process.

### 7.3 Recommended Operating Conditions

over operating free-air temperature range (unless otherwise noted)

		MIN	NOM	MAX	UNIT
V <sub>VDD</sub>		3	3.3	3.6	V
V <sub>VPWR</sub>		44	54	57	V
	Voltage Slew rate on VPWR			1	V/μs
f <sub>SCL</sub>	I <sup>2</sup> C Clock Frequency			400	kHz
T <sub>J</sub>	Junction temperature	-40		125	°C

### 7.4 Thermal Information

THERMAL METRIC <sup>(1)</sup>		TPS23881		UNIT
		RTQ Package (VQFN)		
		56 PINS		
R <sub>θJA</sub>	Junction-to-ambient thermal resistance	25.3		°C/W
R <sub>θJC(top)</sub>	Junction-to-case (top) thermal resistance	9.7		°C/W
R <sub>θJB</sub>	Junction-to-board thermal resistance	3.7		°C/W
Ψ <sub>JT</sub>	Junction-to-top characterization parameter	0.2		°C/W
Ψ <sub>JB</sub>	Junction-to-board characterization parameter	3.7		°C/W
R <sub>θJC(bot)</sub>	Junction-to-case (bottom) thermal resistance	0.5		°C/W

(1) For more information about traditional and new thermal metrics, see the [Semiconductor and IC Package Thermal Metrics](#) application report.

## 7.5 Electrical Characteristics

Conditions are  $-40 < T_J < 125$  °C unless otherwise noted.  $V_{VDD} = 3.3$  V,  $V_{VPWR} = 54$  V,  $V_{DGND} = V_{AGND}$ ,  $DGND$ ,  $KSENSA$ ,  $KSENSB$ ,  $KSENSC$  and  $KSENSD$  connected to  $AGND$ , and all outputs are unloaded,  $2x\text{FBn} = 0$ . Positive currents are into pins.  $R_{SENSE} = 0.200$   $\Omega$ , to  $KSENSA$  (SEN1 or SEN2), to  $KSENSB$  (SEN3 or SEN4), to  $KSENSC$  (SEN5 or SEN6) or to  $KSENSD$  (SEN7 or SEN8). Typical values are at 25 °C. All voltages are with respect to  $AGND$  unless otherwise noted. Operating registers loaded with default values unless otherwise noted.

PARAMETER		TEST CONDITIONS	MIN	TYP	MAX	UNIT
<b>INPUT SUPPLY VPWR</b>						
$I_{VPWR}$	VPWR Current consumption	VVPWR = 54 V		10	12.5	mA
$V_{UVLOPW\_F}$	VPWR UVLO falling threshold	Check internal oscillator stops operating	14.5		17.5	V
$V_{UVLOPW\_R}$	VPWR UVLO rising threshold		15.5		18.5	V
$V_{PUV\_F}$	VPWR Undervoltage falling threshold	VPUV threshold	25	26.5	28	V
<b>INPUT SUPPLY VDD</b>						
$I_{VDD}$	VDD Current consumption			6	12	mA
$V_{UVDD\_F}$	VDD UVLO falling threshold	For channel deassertion	2.1	2.25	2.4	V
$V_{UVDD\_R}$	VDD UVLO rising threshold		2.45	2.6	2.75	V
$V_{UVDD\_HYS}$	Hysteresis VDD UVLO			0.35		V
$V_{UVW\_F}$	VDD UVLO warning threshold	VDD falling	2.6	2.8	3	V
<b>A/D CONVERTERS</b>						
$T_{CONV\_I}$	Conversion time	All ranges, each channel	0.64	0.8	0.96	ms
$T_{CONV\_V}$	Conversion time	All ranges, each channel	0.82	1.03	1.2	ms
$T_{INT\_CUR}$	Integration time, Current	Each channel, channel ON current	82	102	122	ms
$T_{INT\_DET}$	Integration time, Detection		13.1	16.6	20	ms
$T_{INT\_channelV}$	Integration time, Channel Voltage	channel powered	3.25	4.12	4.9	ms
$T_{INT\_inV}$	Integration time, Input Voltage		3.25	4.12	4.9	ms
	Input voltage conversion scale factor and accuracy	VVPWR = 57 V	15175	15565	15955	Counts
			55.57	57	58.43	V
	Powered Channel voltage conversion scale factor and accuracy	VVPWR = 44 V	11713	12015	12316	Counts
			42.89	44	45.10	V
	Powered Channel voltage conversion scale factor and accuracy	VVPWR - VDRAINn = 57 V	15175	15565	15955	Counts
			55.57	57	58.43	V
	Powered Channel voltage conversion scale factor and accuracy	VVPWR - VDRAINn = 44 V	11713	12015	12316	Counts
			42.89	44	45.10	V
$\delta V/V_{Channel}$	Voltage reading accuracy		-2.5		2.5	%
	Powered Channel current conversion scale factor and accuracy	Channel current = 770 mA	8431	8604	8776	Counts
			754.5	770	785.4	mA
		Channel Current = 100 mA	1084	1118	1152	Counts
			97	100	103	mA
$\delta I/I_{Channel}$	Current reading accuracy	Channel Current = 100 mA	-3		3	%
		Channel Current = 770 mA	-2		2	%
	Powered Channel current full scale output	Channel currents = 1.5 A, $2x\text{FBn} = 1$	14959	15671		Counts
			1.34	1.400		A
$\sigma I$	Current Reading Repeatability	Full Scale reading	-7.5		7.5	mA
$\delta R/R_{Channel}$	Resistance reading accuracy	$15 \text{ k}\Omega \leq R_{Channel} \leq 33 \text{ k}\Omega$ , $C_{Channel} \leq 0.25 \mu\text{F}$	-7		7	%
$I_{bias}$	Sense Pin bias current	Channel ON or during class	-2.5		0	$\mu\text{A}$



## Electrical Characteristics (continued)

Conditions are  $-40 < T_J < 125$  °C unless otherwise noted.  $V_{DD} = 3.3$  V,  $V_{VPWR} = 54$  V,  $V_{DGND} = V_{AGND}$ , DGND, KSENSA, KSENSB, KSENSC and KSENSD connected to AGND, and all outputs are unloaded,  $2x\text{FBn} = 0$ . Positive currents are into pins.  $R_{SENSE} = 0.200$  Ω, to KSENSA (SEN1 or SEN2), to KSENSB (SEN3 or SEN4), to KSENSC (SEN5 or SEN6) or to KSENSD (SEN7 or SEN8). Typical values are at 25 °C. All voltages are with respect to AGND unless otherwise noted. Operating registers loaded with default values unless otherwise noted.

PARAMETER		TEST CONDITIONS	MIN	TYP	MAX	UNIT
<b>GATE 1-8</b>						
$V_{GOH}$	Gate drive voltage	$V_{GATEn}$ , $I_{GATE} = -1$ μA	10		12.5	V
$I_{GO-}$	Gate sinking current with Power-on Reset, OSS detected or channel turnoff command	$V_{GATEn} = 5$ V	60	100	190	mA
$I_{GO\ short-}$	Gate sinking current with channel short-circuit	$V_{GATEn} = 5$ V, $V_{SENn} \geq V_{short}$ (or $V_{short2X}$ if 2X mode)	60	100	190	mA
$I_{GO+}$	Gate sourcing current	$V_{GATEn} = 0$ V, default selection	39	50	63	μA
$t_{D\_off\_OSS}$	Gate turnoff time from 1-bit OSS input	From OSS to $V_{GATEn} < 1$ V, $V_{SENn} = 0$ V, $MbitPrty = 0$	1		5	μs
$t_{OSS\_OFF}$	Gate turnoff time from 3-bit OSS input	From Start bit falling edge to $V_{GATEn} < 1$ V, $V_{SENn} = 0$ V, $MbitPrty = 1$	72		104	μs
$t_{P\_off\_CMD}$	Gate turnoff time from channel turnoff command	From Channel off command ( $POFFn = 1$ ) to $V_{GATEn} < 1$ V, $V_{SENn} = 0$ V			300	μs
$t_{P\_off\_RST}$	Gate turnoff time with /RESET	From /RESET low to $V_{GATEn} < 1$ V, $V_{SENn} = 0$ V	1		5	μs
<b>DRAIN 1-8</b>						
$V_{PGT}$	Power-Good threshold	Measured at $V_{DRAINn}$	1	2.13	3	V
$V_{SHT}$	Shorted FET threshold	Measured at $V_{DRAINn}$	4	6	8	V
$R_{DRAIN}$	Resistance from DRAINn to VPWR	Any operating mode except during detection or while the Channel is ON, including in device RESET state	80	100	190	kΩ
<b>AUTOCLASS</b>						
$t_{Class\_ACS}$	Start of Autoclass Detection	Measured from the start of Class	90		100	ms
$t_{AUTO\_PSE1}$	Start of Autoclass Power Measurement	Measured from the end of Inrush	1.4		1.6	s
		Measured from setting the MACx bit while channel is already powered			10	ms
$t_{AUTO}$	Duration of Autoclass Power Measurement		1.7	1.8	1.9	s
$t_{AUTO\_window}$	Autoclass Power Measurement Sliding Window		0.15		0.3	s
$P_{AC}$	Autoclass Channel Power conversion scale factor and accuracy	$VPWR = 52$ V, $VDRAINn = 0$ V, Channel current = 770 mA	76	80	84	Counts
		$VPWR = 50$ V, $VDRAINn = 0$ V, Channel current = 100 mA	9	10	11	

## Electrical Characteristics (continued)

Conditions are  $-40 < T_J < 125$  °C unless otherwise noted.  $V_{DD} = 3.3$  V,  $V_{VPWR} = 54$  V,  $V_{DGND} = V_{AGND}$ , DGND, KSENSA, KSENSB, KSENSC and KSENSD connected to AGND, and all outputs are unloaded,  $2x_{FBn} = 0$ . Positive currents are into pins.  $R_{SENSE} = 0.200$  Ω, to KSENSA (SEN1 or SEN2), to KSENSB (SEN3 or SEN4), to KSENSC (SEN5 or SEN6) or to KSENSD (SEN7 or SEN8). Typical values are at 25 °C. All voltages are with respect to AGND unless otherwise noted. Operating registers loaded with default values unless otherwise noted.

PARAMETER		TEST CONDITIONS	MIN	TYP	MAX	UNIT
<b>DETECTION</b>						
$I_{DISC}$	Detection current	First and 3rd detection points VVPWR - VDRAINn = 0 V	145	160	190	μA
		2nd and 4th detection points VVPWR - VDRAINn = 0 V	235	270	300	
$\Delta I_{DISC}$	2nd – 1st detection currents	VVPWR - VDRAINn = 0 V	98	110	118	μA
$V_{det\_open}$	Open circuit detection voltage	Measured as VVPWR - VDRAINn	23.5	26	29	V
$R_{REJ\_LOW}$	Rejected resistance low range		0.86		15	kΩ
$R_{REJ\_HI}$	Rejected resistance high range		33		100	kΩ
$R_{ACCEPT}$	Accepted resistance range		19	25	26.5	kΩ
$R_{SHORT}$	Shorted Channel threshold				360	Ω
$R_{OPEN}$	Open Channel Threshold		400			kΩ
$t_{DET}$	Detection Duration	Time to complete a detection, 4Pxx = 0	275	350	425	ms
$t_{CC}$	Connection Check Duration	Time to complete connection check after a valid detection, 4Pxx = 1		150	400	ms
$t_{DET\_BOFF}$	Detect backoff pause between discovery attempts	VVPWR - VDRAINn > 2.5 V	300	400	500	ms
		VVPWR - VDRAINn < 2.5 V	20		100	ms
$t_{DET\_DLY}$	Detection delay	From command or PD attachment to Channel detection complete 4Pxx = 0			590	ms
	Capactance Measurement	Cport = 10uF	8.5	10	11.5	uF
<b>CLASSIFICATION</b>						
$V_{CLASS}$	Classification Voltage	VVPWR - VDRAINn, VSEn ≥ 0 mV $I_{channel} \geq 180$ μA	15.5	18.5	20.5	V
$I_{CLASS\_Lim}$	Classification Current Limit	VVPWR - VDRAINn = 0 V	65	75	90	mA
$I_{CLASS\_TH}$	Classification Threshold Current	Class 0-1	5		8	mA
		Class 1-2	13		16	mA
		Class 2-3	21		25	mA
		Class 3-4	31		35	mA
		Class 4-Class overcurrent	45		51	mA
$t_{LCE}$	Classification Duration (1st Finger)	From detection complete	95		105	ms
$t_{CLE2-5}$	Classification Duration (2nd- 5th Finger)	From Mark complete	6.5		12	ms
<b>MARK</b>						
$V_{MARK}$	Mark Voltage	4 mA ≥ IChannel ≥ 180 μA VVPWR - VDRAINn	7		10	V
$I_{MARK\_Lim}$	Mark Sinking Current Limit	VVPWR - VDRAINn = 0 V	60	75	90	mA
$t_{ME}$	Mark Duration		6		12	ms

## Electrical Characteristics (continued)

Conditions are  $-40 < T_J < 125$  °C unless otherwise noted.  $V_{DD} = 3.3$  V,  $V_{VPWR} = 54$  V,  $V_{DGND} = V_{AGND}$ , DGND, KSENSA, KSENSB, KSENSC and KSENSD connected to AGND, and all outputs are unloaded,  $2x_{FBn} = 0$ . Positive currents are into pins.  $R_{SENSE} = 0.200$  Ω, to KSENSA (SEN1 or SEN2), to KSENSB (SEN3 or SEN4), to KSENSC (SEN5 or SEN6) or to KSENSD (SEN7 or SEN8). Typical values are at 25 °C. All voltages are with respect to AGND unless otherwise noted. Operating registers loaded with default values unless otherwise noted.

PARAMETER		TEST CONDITIONS	MIN	TYP	MAX	UNIT	
<b>DC DISCONNECT</b>							
$V_{IMIN}$	DC disconnect threshold	DCDTxx = 0	0.8	1.3	1.8	mV	
		DCDTxx = 1	0.4	0.9	1.4	mV	
$t_{MPDO}$	PD Maintain Power signature dropout time limit	TMPDO = 00	320		400	ms	
		TMPDO = 01	75		100	ms	
		TMPDO = 10	150		200	ms	
		TMPDO = 11	600		800	ms	
$t_{MPS}$	PD Maintain Power Signature time for validity		2.5	3	ms		
<b>PORT POWER POLICING</b>							
$\delta P_{CUT}/P_{CUT}$	PCUT tolerance	$POL \leq 15W$	0	5	10	%	
$\delta P_{CUT}/P_{CUT}$	PCUT tolerance	$15W < POL < 90W$	0	3	6	%	
$\delta P_{CUT}/P_{CUT}$	PCUT tolerance	$POL \geq 90W$	0	2.5	5	%	
$t_{OVLD}$	PCUT time limit	TOVLD = 00	50		70	ms	
		TOVLD = 01	25		35		
		TOVLD = 10	100		140		
		TOVLD = 11	200		280		
<b>PORT CURRENT INRUSH</b>							
$V_{Inrush}$	Inrush limit, ALTIRNn = 0	VVPWR - VDRAINn = 1 V	19	30	41	mV	
		VVPWR - VDRAINn = 10 V	19	30	41		
		VVPWR - VDRAINn = 15 V	33	44	55		
		VVPWR - VDRAINn = 30 V	80		90		
	Inrush limit, ALTIRNn = 1	VVPWR - VDRAINn = 55 V	80		90		
		VVPWR - VDRAINn = 1 V	19	30	41		
		VVPWR - VDRAINn = 10 V	36	47	58		
		VVPWR - VDRAINn = 15 V	53	64	75		
	VVPWR - VDRAINn = 30 V	80		90			
	VVPWR - VDRAINn = 55 V	80		90			
	$t_{START}$	Maximum current limit duration in start-up	TSTART = 00	50		70	ms
			TSTART = 01	25		35	
TSTART = 10			100		140		

### Electrical Characteristics (continued)

Conditions are  $-40 < T_J < 125$  °C unless otherwise noted.  $V_{DD} = 3.3$  V,  $V_{VPWR} = 54$  V,  $V_{DGND} = V_{AGND}$ , DGND, KSENSA, KSENSB, KSENSC and KSENSD connected to AGND, and all outputs are unloaded,  $2x\text{FBn} = 0$ . Positive currents are into pins.  $R_{SENSE} = 0.200$  Ω, to KSENSA (SEN1 or SEN2), to KSENSB (SEN3 or SEN4), to KSENSC (SEN5 or SEN6) or to KSENSD (SEN7 or SEN8). Typical values are at 25 °C. All voltages are with respect to AGND unless otherwise noted. Operating registers loaded with default values unless otherwise noted.

PARAMETER		TEST CONDITIONS	MIN	TYP	MAX	UNIT
<b>PORT CURRENT FOLDBACK</b>						
$V_{LIM}$	ILIM 1X limit, $2x\text{FBn} = 0$ and $\text{ALT}\text{FBn} = 0$	$\text{VDRAINn} = 1$ V	80		90	mV
		$\text{VDRAINn} = 15$ V	80		90	
		$\text{VDRAINn} = 30$ V	51	58	65	
		$\text{VDRAINn} = 50$ V	23	30	37	
	ILIM 1X limit, $2x\text{FBn} = 0$ and $\text{ALT}\text{FBn} = 1$	$\text{VDRAINn} = 1$ V	80		90	
		$\text{VDRAINn} = 25$ V	80		90	
		$\text{VDRAINn} = 40$ V	45	51	57	
		$\text{VDRAINn} = 50$ V	23	30	37	
$V_{LIM2X}$	ILIM 2X limit, $2x\text{FBn} = 1$ and $\text{ALT}\text{FBn} = 0$	$\text{VDRAINn} = 1$ V	245	250	262	mV
		$\text{VDRAINn} = 10$ V	164	180	196	
		$\text{VDRAINn} = 30$ V	51	58	64	
		$\text{VDRAINn} = 50$ V	23	30	37	
	ILIM 2X limit, $2x\text{FBn} = 1$ and $\text{ALT}\text{FBn} = 1$	$\text{VDRAINn} = 1$ V	245	250	262	
		$\text{VDRAINn} = 20$ V	139	147	155	
		$\text{VDRAINn} = 40$ V	45	51	57	
		$\text{VDRAINn} = 50$ V	23	30	37	
$t_{LIM}$	ILIM time limit	$2x\text{FBn} = 0$	55	60	65	ms
	$2x\text{FBn} = 1$	TLIM = 00	55	60	65	
		TLIM = 01	15	16	17	
		TLIM = 10	10	11	12	
		TLIM = 11	6	6.5	7	
<b>SHORT CIRCUIT DETECTION</b>						
$V_{short}$	$I_{SHORT}$ threshold in 1X mode and during inrush		205		245	mV
$V_{short2X}$	$I_{SHORT}$ threshold in 2X mode		280		320	
$t_{D\_off\_SEN}$	Gate turnoff time from SENn input	$2x\text{FBn} = 0$ , $\text{VDRAINn} = 1$ V From $V_{SENn}$ pulsed to 0.425 V.			0.9	μs
		$2x\text{FBn} = 1$ , $\text{VDRAINn} = 1$ V From $V_{SENn}$ pulsed to 0.62 V.			0.9	
<b>CURRENT FAULT RECOVERY (BACKOFF) TIMING</b>						
$t_{ed}$	Error delay timing. Delay before next attempt to power a channel following power removal due to error condition	$P_{CUT}$ , $I_{LIM}$ or $I_{Inrush}$ fault Semi-auto mode	0.8	1	1.2	s
$\delta I_{fault}$	Duty cycle of $I_{channel}$ with current fault		5.5		6.7	%
<b>THERMAL SHUTDOWN</b>						
	Shutdown temperature	Temperature rising	135	146		°C
	Hysteresis			7		°C

## Electrical Characteristics (continued)

Conditions are  $-40 < T_J < 125$  °C unless otherwise noted.  $V_{DD} = 3.3$  V,  $V_{VPWR} = 54$  V,  $V_{DGND} = V_{AGND}$ , DGND, KSENSA, KSENSB, KSENSC and KSENSD connected to AGND, and all outputs are unloaded,  $2x\text{FBn} = 0$ . Positive currents are into pins.  $R_{SENSE} = 0.200$   $\Omega$ , to KSENSA (SEN1 or SEN2), to KSENSB (SEN3 or SEN4), to KSENSC (SEN5 or SEN6) or to KSENSD (SEN7 or SEN8). Typical values are at 25 °C. All voltages are with respect to AGND unless otherwise noted. Operating registers loaded with default values unless otherwise noted.

PARAMETER		TEST CONDITIONS	MIN	TYP	MAX	UNIT
<b>DIGITAL I/O (SCL, SDAI, A1-A4, /RESET, OSS unless otherwise stated)</b>						
$V_{IH}$	Digital input High		2.1			V
$V_{IL}$	Digital input Low				0.9	V
$V_{IT\_HYS}$	Input voltage hysteresis		0.17			V
$V_{OL}$	Digital output Low	SDAO at 9mA			0.4	V
	Digital output Low	/INT at 3mA			0.4	V
$R_{pullup}$	Pullup resistor to VDD	/RESET, A1-A4, TEST0	30	50	80	k $\Omega$
$R_{pulldown}$	Pulldown resistor to DGND	OSS, TEST1, TEST2	30	50	80	k $\Omega$
$t_{FLT\_INT}$	Fault to /INT assertion	Time to internally register an Interrupt fault, from Channel turn off		50	500	$\mu$ s
$T_{RESETmin}$	/RESET input minimum pulse width				5	$\mu$ s
$T_{bit\_OSS}$	3-bit OSS bit period	MbitPrty = 1	24	25	26	$\mu$ s
$t_{OSS\_IDL}$	Idle time between consecutive shutdown code transmission in 3-bit mode	MbitPrty = 1	48	50		$\mu$ s
$t_{r\_OSS}$	Input rise time of OSS in 3-bit mode	0.8 V $\rightarrow$ 2.3 V, MbitPrty = 1	1		300	ns
$t_{f\_OSS}$	Input fall time of OSS in 3-bit mode	2.3 V $\rightarrow$ 0.8 V, MbitPrty = 1	1		300	ns
<b>I2C TIMING REQUIREMENTS</b>						
$t_{POR}$	Device power-on reset delay				20	ms
$f_{SCL}$	SCL clock frequency		10		400	kHz
$t_{LOW}$	LOW period of the clock		0.5			$\mu$ s
$t_{HIGH}$	HIGH period of the clock		0.26			$\mu$ s
$t_{fo}$	SDAO output fall time	SDAO, 2.3 V $\rightarrow$ 0.8 V, $C_b = 10$ pF, 10 k $\Omega$ pull-up to 3.3 V	10		50	ns
		SDAO, 2.3 V $\rightarrow$ 0.8 V, $C_b = 400$ pF, 1.3 k $\Omega$ pull-up to 3.3 V	10		50	ns
$C_{I2C}$	SCL capacitance				10	pF
$C_{I2C\_SDA}$	SDAI, SDAO capacitance				6	pF
$t_{SU\_DATW}$	Data setup tme (Write operation)		50			ns
$t_{HD\_DATW}$	Data hold time (Write operation)		0			ns
$t_{HD\_DATR}$	Data hold time (Read operation)		150		400	ns
$t_{f\_SDA}$	Input fall times of SDAI	2.3 V $\rightarrow$ 0.8 V	20		120	ns
$t_{r\_SDA}$	Input rise times of SDAI	0.8 V $\rightarrow$ 2.3 V	20		120	ns
$t_r$	Input rise time of SCL	0.8 V $\rightarrow$ 2.3 V	20		120	ns
$t_f$	Input fall time of SCL	2.3 V $\rightarrow$ 0.8 V	20		120	ns
$t_{BUF}$	Bus free time between a STOP and START condition		0.5			$\mu$ s
$t_{HD\_STA}$	Hold time After (Repeated) START condition		0.26			$\mu$ s
$t_{SU\_STA}$	Repeated START condition setup time		0.26			$\mu$ s
$t_{SU\_STO}$	STOP condition setup time		0.26			$\mu$ s
$t_{DG}$	Suppressed spike pulse width, SDAI and SCL		50			ns
$t_{WDT\_I2C}$	I2C Watchdog trip delay		1.1	2.2	3.3	sec

## 7.6 Typical Characteristics

Conditions are  $-40 < T_J < 125$  °C unless otherwise noted.  $V_{VDD} = 3.3$  V,  $V_{VPWR} = 54$  V,  $V_{DGND} = V_{AGND}$ , DGND, KSENSA, KSENSB, KSENSC and KSENSD connected to AGND, and all outputs are unloaded,  $2x\text{FBn} = 0$ . Positive currents are into pins.  $R_S = 0.200$   $\Omega$ , to KSENSA (SEN1 or SEN2), to KSENSB (SEN3 or SEN4), to KSENSC (SEN5 or SEN6) or to KSENSD (SEN7 or SEN8). Typical values are at 25 °C. All voltages are with respect to AGND unless otherwise noted. Operating registers loaded with default values unless otherwise noted.

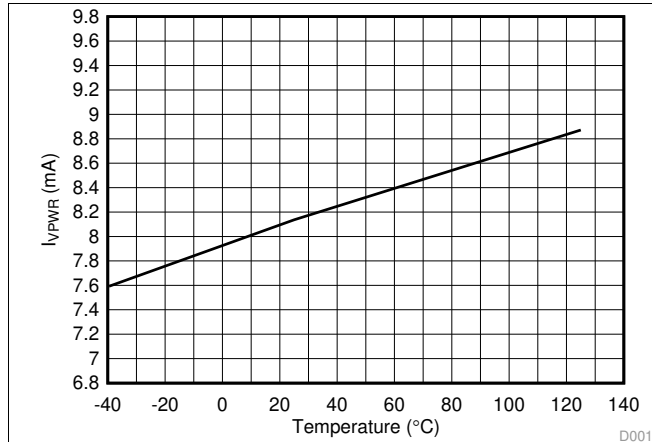


Figure 1. VPWR Current Consumption vs Temperature

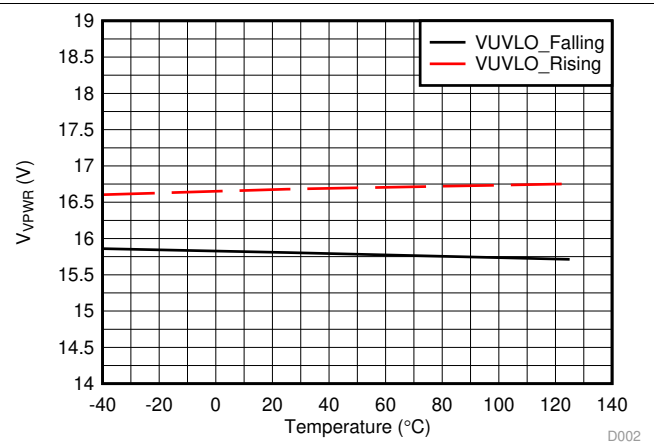


Figure 2. VPWR UVLO Thresholds vs Temperature

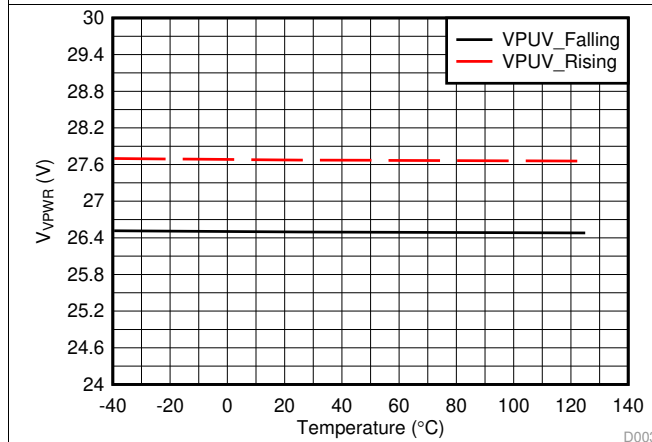


Figure 3. VPUV Thresholds vs Temperature

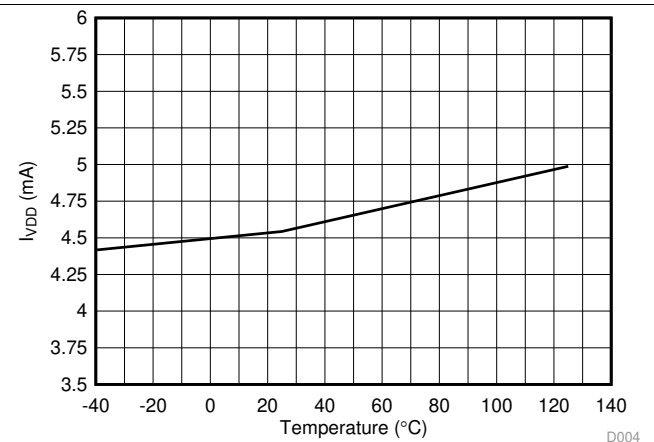


Figure 4. VDD Current Consumption vs Temperature

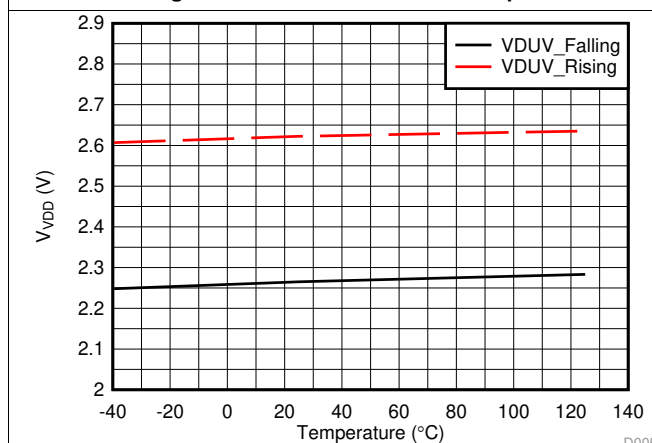


Figure 5. VDUV Thresholds vs Temperature

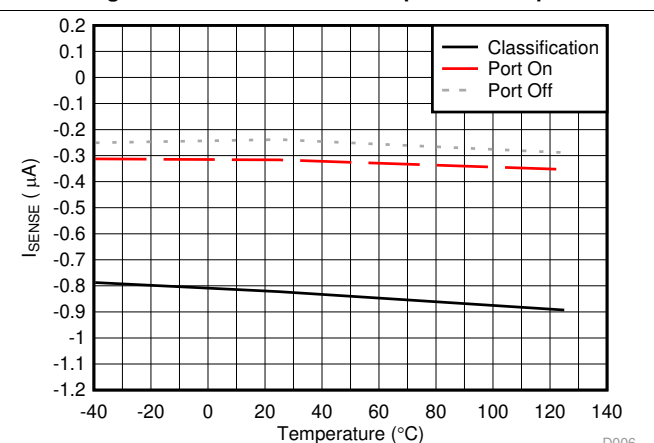
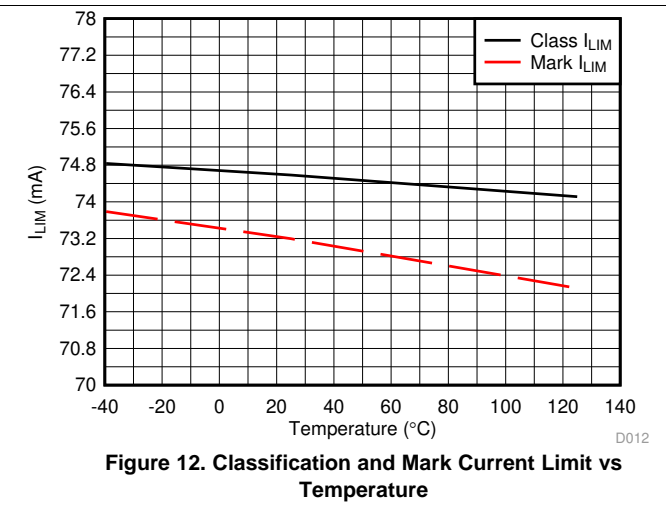
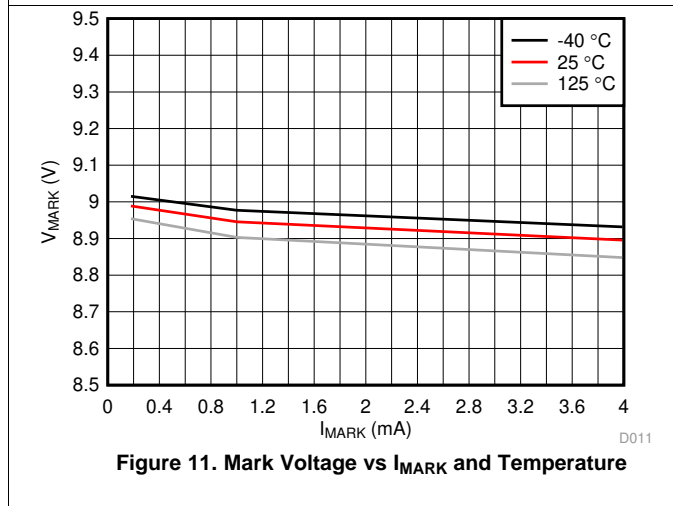
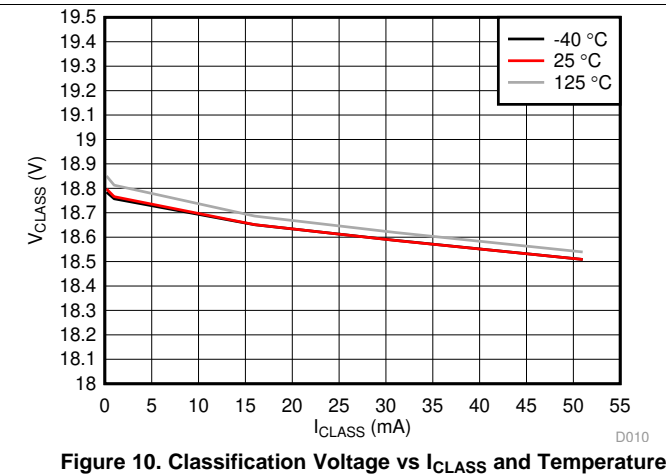
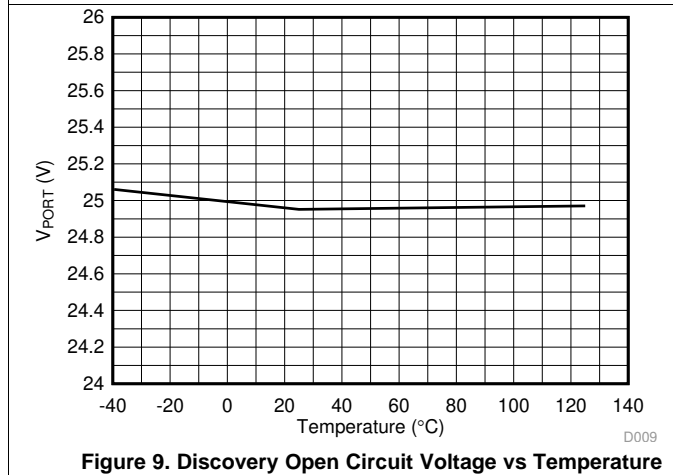
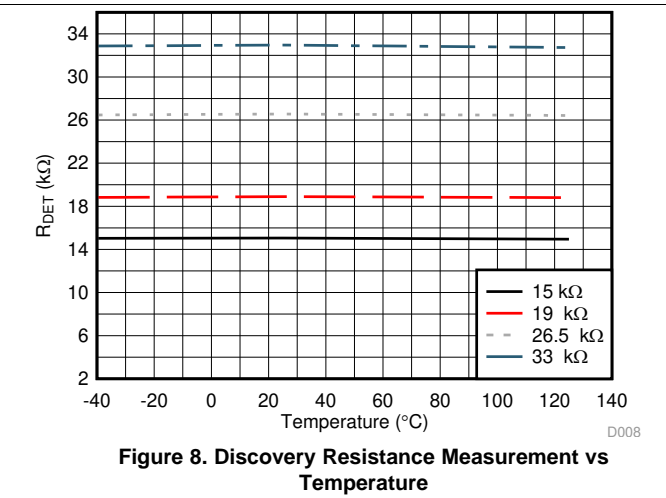
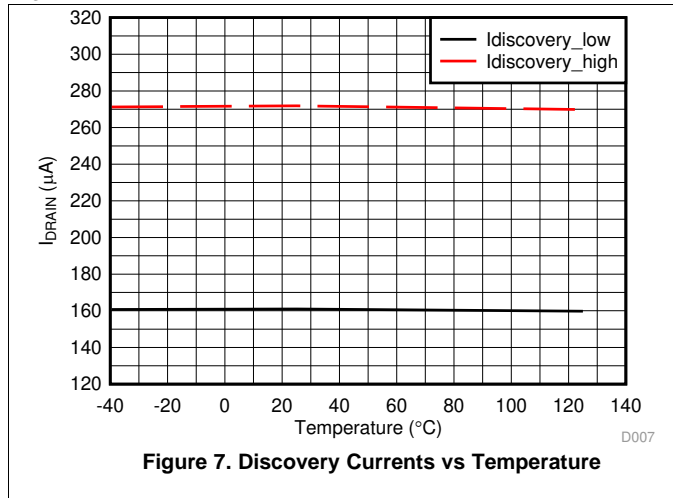


Figure 6. SENSE Pin Bias Current vs Temperature

### Typical Characteristics (continued)

Conditions are  $-40 < T_J < 125$  °C unless otherwise noted.  $V_{DD} = 3.3$  V,  $V_{PWR} = 54$  V,  $V_{DGND} = V_{AGND}$ , DGND, KSENSA, KSENSB, KSENSC and KSENSD connected to AGND, and all outputs are unloaded,  $2x\text{FBn} = 0$ . Positive currents are into pins.  $R_S = 0.200$   $\Omega$ , to KSENSA (SEN1 or SEN2), to KSENSB (SEN3 or SEN4), to KSENSC (SEN5 or SEN6) or to KSENSD (SEN7 or SEN8). Typical values are at 25 °C. All voltages are with respect to AGND unless otherwise noted. Operating registers loaded with default values unless otherwise noted.



### Typical Characteristics (continued)

Conditions are  $-40 < T_J < 125$  °C unless otherwise noted.  $V_{VDD} = 3.3$  V,  $V_{VPWR} = 54$  V,  $V_{DGND} = V_{AGND}$ , DGND, KSENSA, KSENSB, KSENSC and KSENSD connected to AGND, and all outputs are unloaded,  $2x\text{FBn} = 0$ . Positive currents are into pins.  $R_S = 0.200$   $\Omega$ , to KSENSA (SEN1 or SEN2), to KSENSB (SEN3 or SEN4), to KSENSC (SEN5 or SEN6) or to KSENSD (SEN7 or SEN8). Typical values are at 25 °C. All voltages are with respect to AGND unless otherwise noted. Operating registers loaded with default values unless otherwise noted.

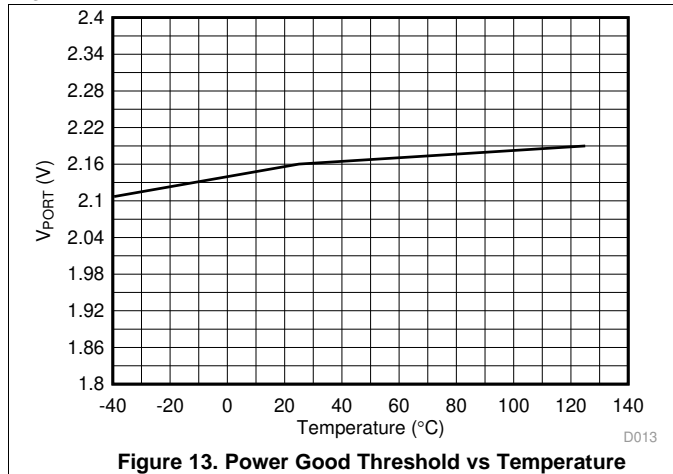


Figure 13. Power Good Threshold vs Temperature

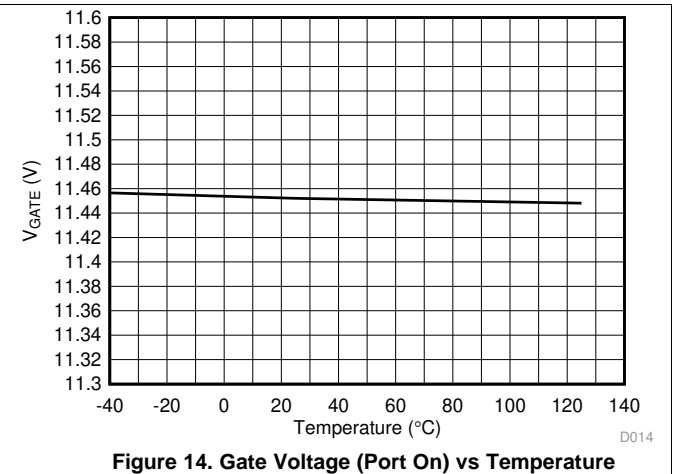


Figure 14. Gate Voltage (Port On) vs Temperature

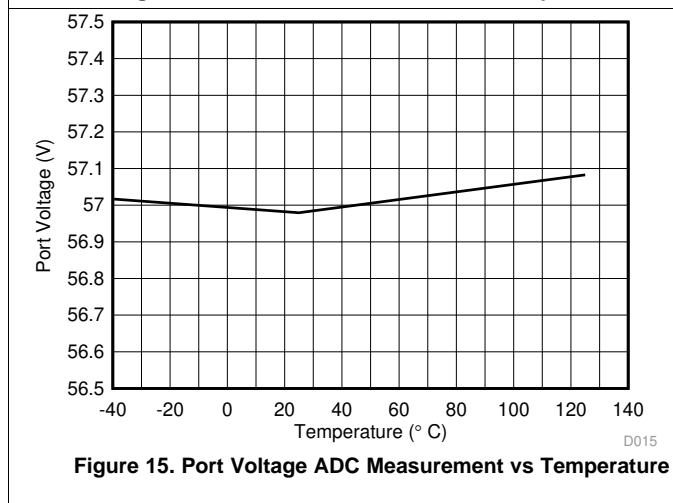


Figure 15. Port Voltage ADC Measurement vs Temperature

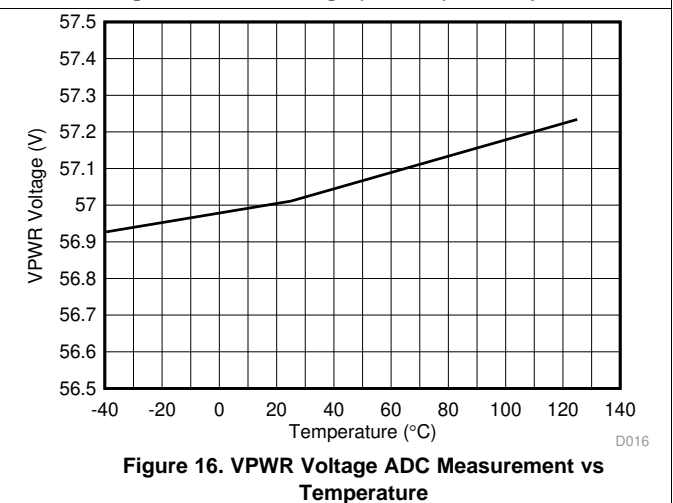


Figure 16. VPWR Voltage ADC Measurement vs Temperature

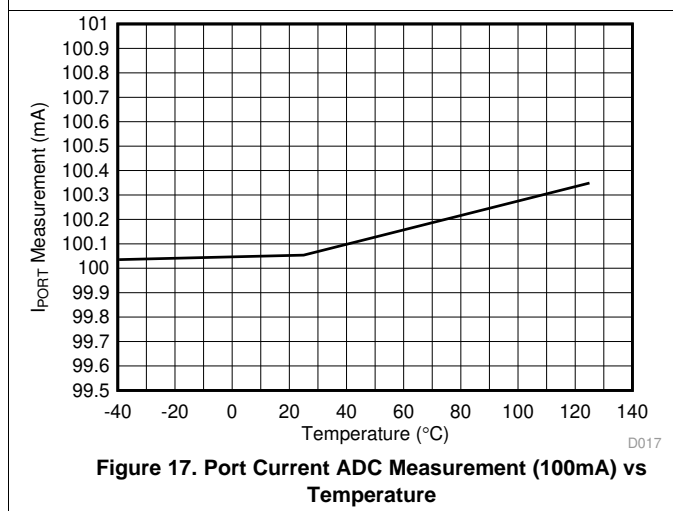


Figure 17. Port Current ADC Measurement (100mA) vs Temperature

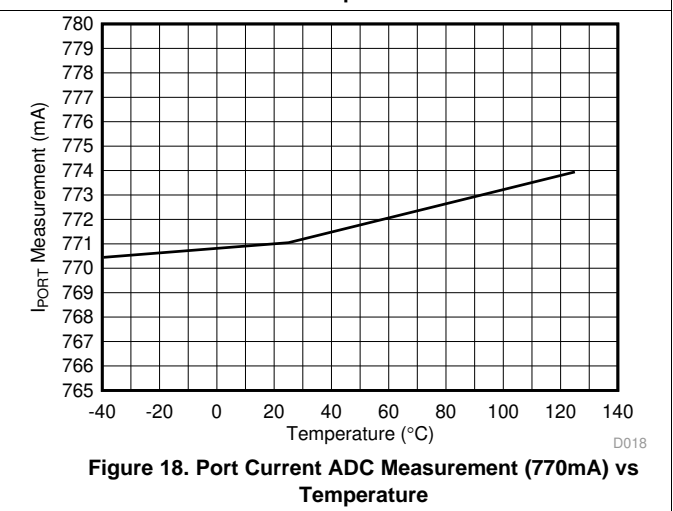
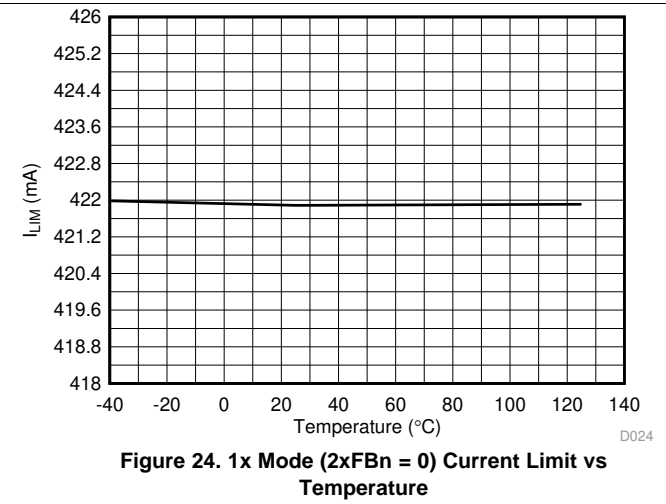
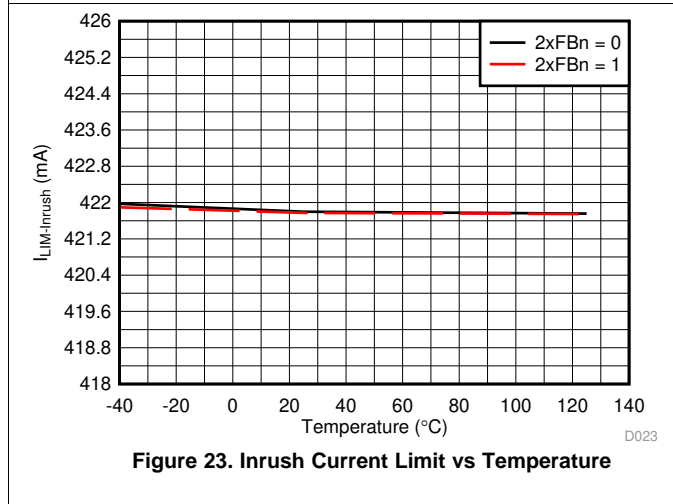
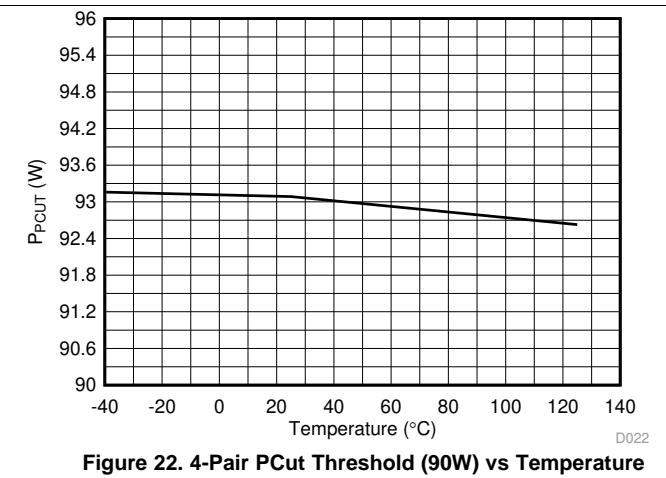
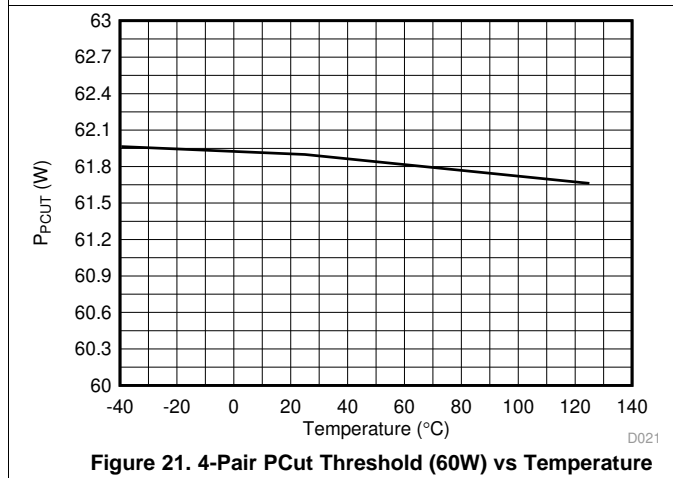
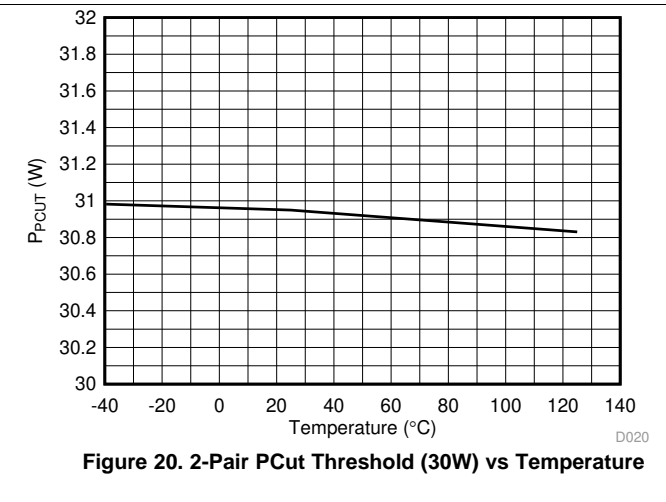
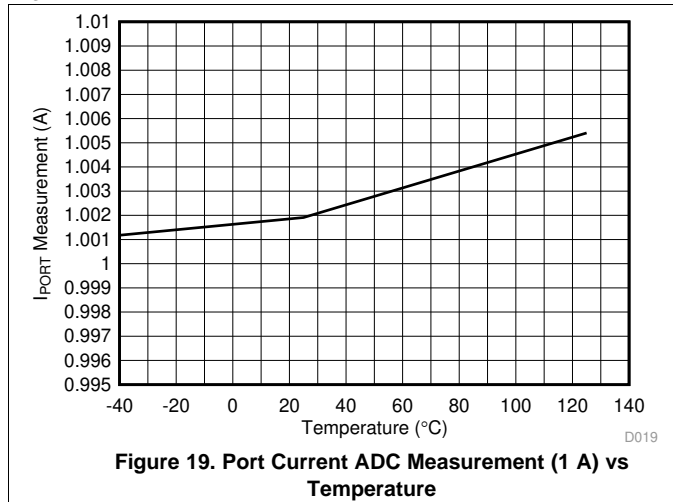


Figure 18. Port Current ADC Measurement (770mA) vs Temperature



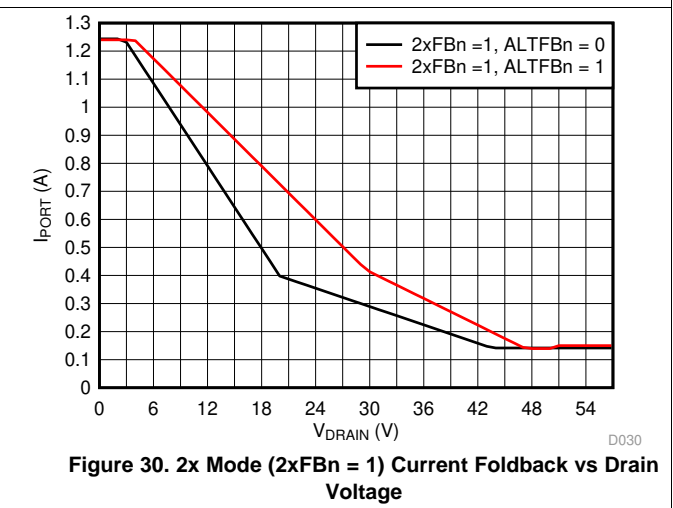
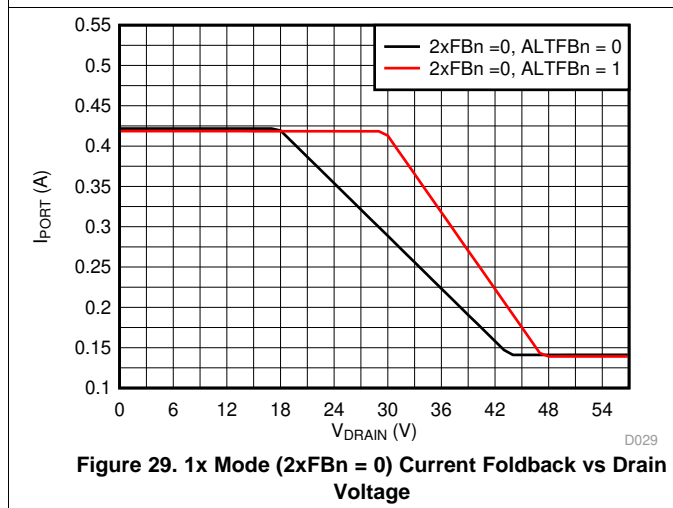
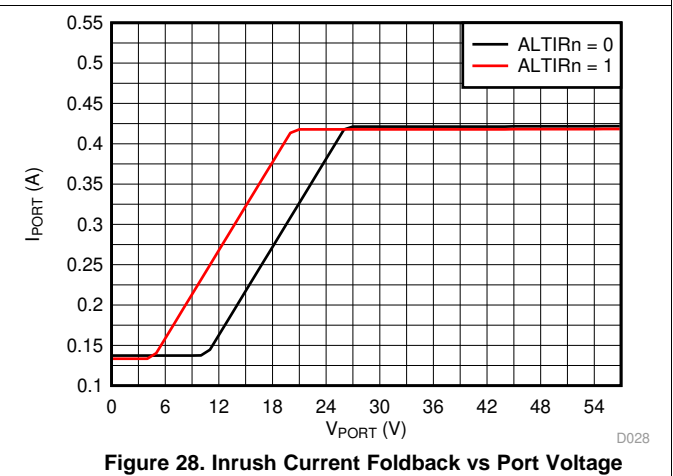
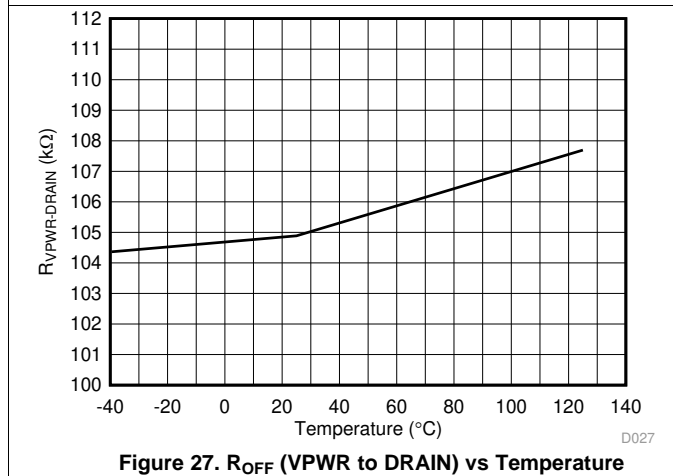
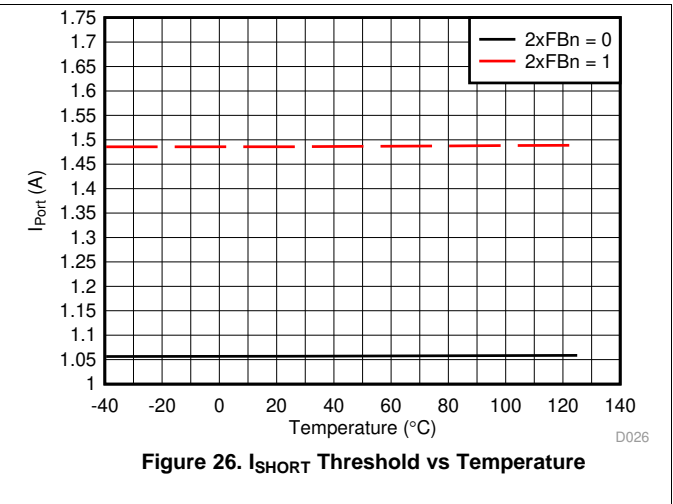
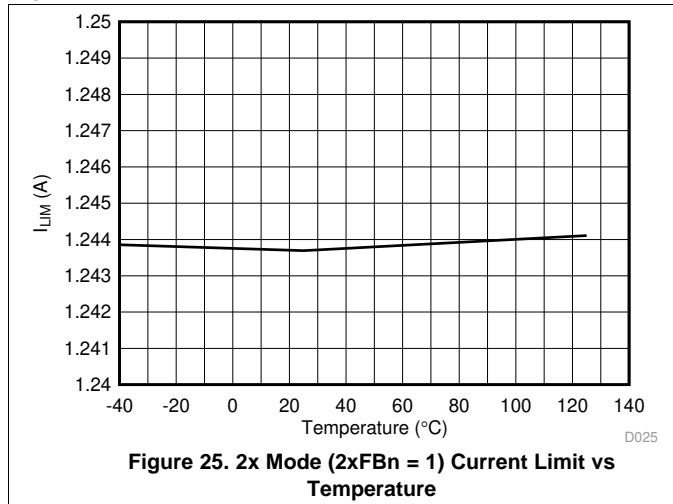
### Typical Characteristics (continued)

Conditions are  $-40 < T_J < 125$  °C unless otherwise noted.  $V_{DD} = 3.3$  V,  $V_{PWR} = 54$  V,  $V_{DGND} = V_{AGND}$ , DGND, KSENSA, KSENSB, KSENSC and KSENSD connected to AGND, and all outputs are unloaded,  $2x\text{FBn} = 0$ . Positive currents are into pins.  $R_S = 0.200$   $\Omega$ , to KSENSA (SEN1 or SEN2), to KSENSB (SEN3 or SEN4), to KSENSC (SEN5 or SEN6) or to KSENSD (SEN7 or SEN8). Typical values are at 25 °C. All voltages are with respect to AGND unless otherwise noted. Operating registers loaded with default values unless otherwise noted.



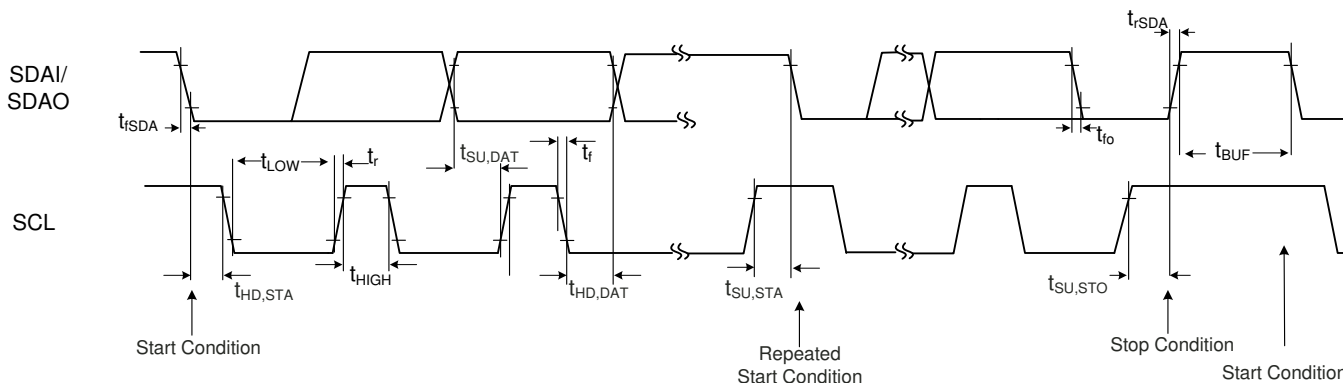
### Typical Characteristics (continued)

Conditions are  $-40 < T_J < 125$  °C unless otherwise noted.  $V_{DD} = 3.3$  V,  $V_{PWR} = 54$  V,  $V_{DGND} = V_{AGND}$ , DGND, KSENSA, KSENSB, KSENSC and KSENSD connected to AGND, and all outputs are unloaded,  $2x\text{FBn} = 0$ . Positive currents are into pins.  $R_S = 0.200$   $\Omega$ , to KSENSA (SEN1 or SEN2), to KSENSB (SEN3 or SEN4), to KSENSC (SEN5 or SEN6) or to KSENSD (SEN7 or SEN8). Typical values are at 25 °C. All voltages are with respect to AGND unless otherwise noted. Operating registers loaded with default values unless otherwise noted.

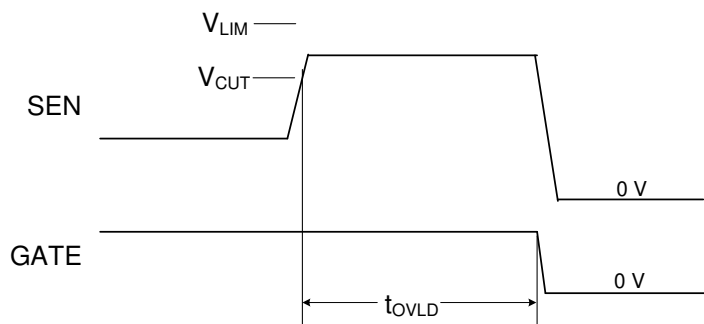


## 8 Parameter Measurement Information

### 8.1 Timing Diagrams

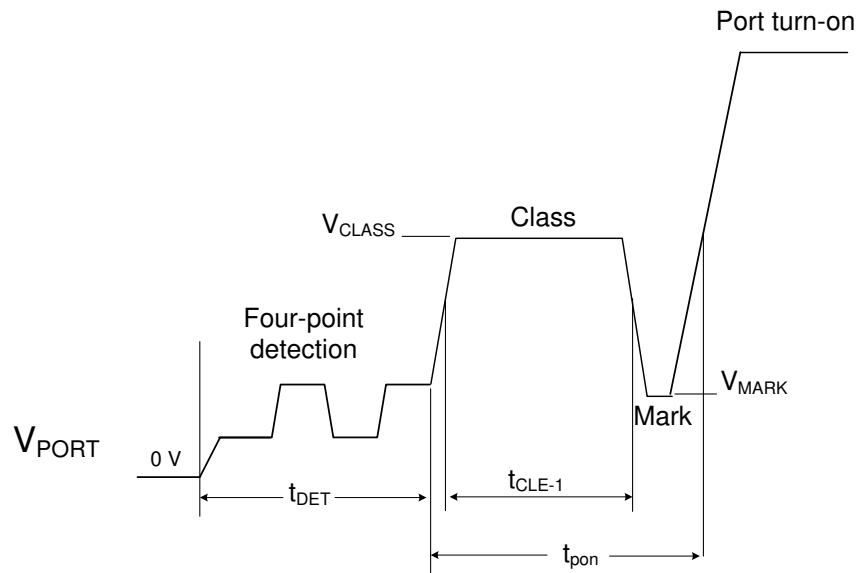


**Figure 31. I<sup>2</sup>C Timings**

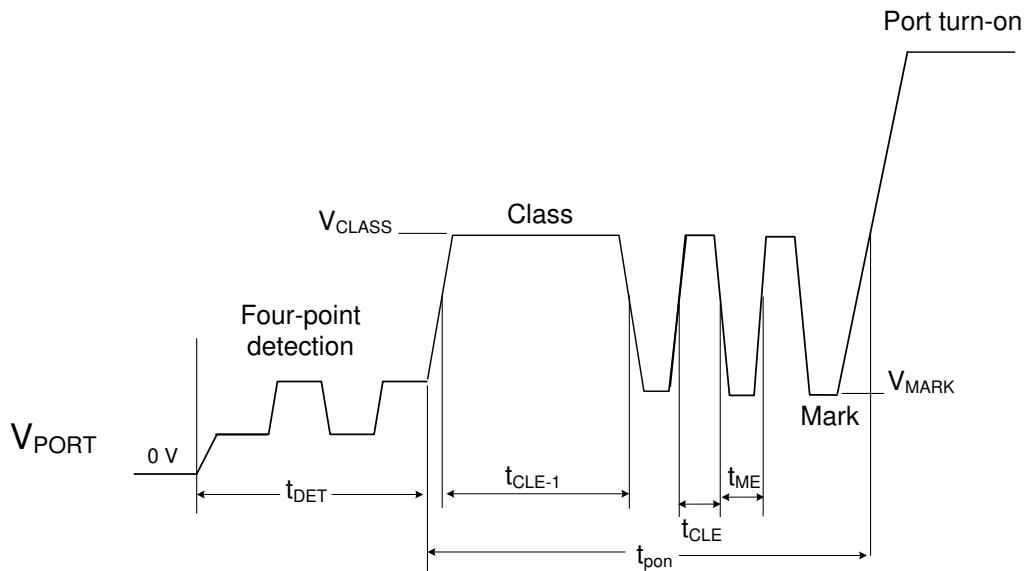


**Figure 32. Overcurrent Fault Timing**

**Timing Diagrams (continued)**



**Figure 33. 2-Pair Detection, 1-Event Classification and Turn On**



**Figure 34. 2-Pair Detection, 3-Event Classification and Turn On**

Timing Diagrams (continued)

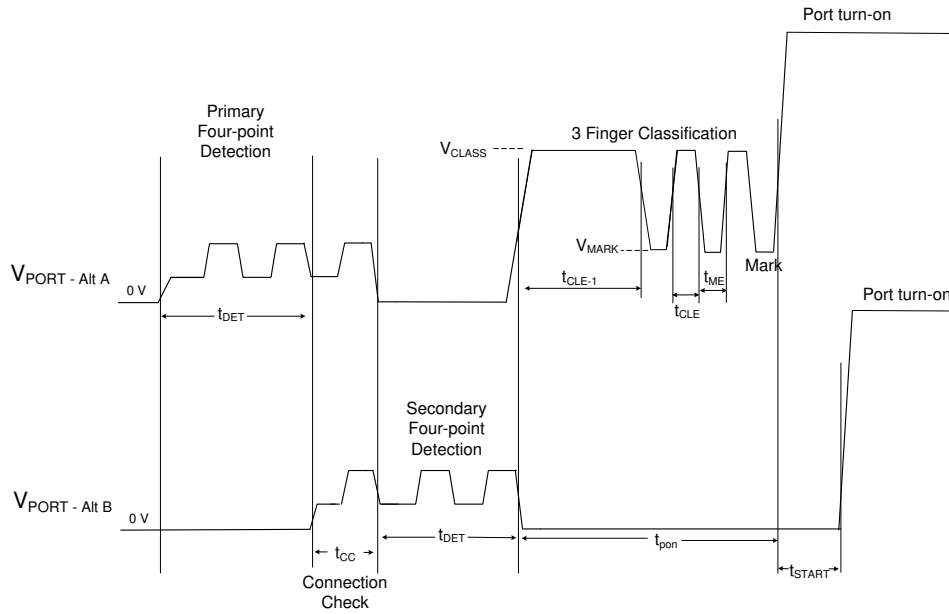


Figure 35. 4-Pair Single Signature Detection, 3-Event Classification and Turn On

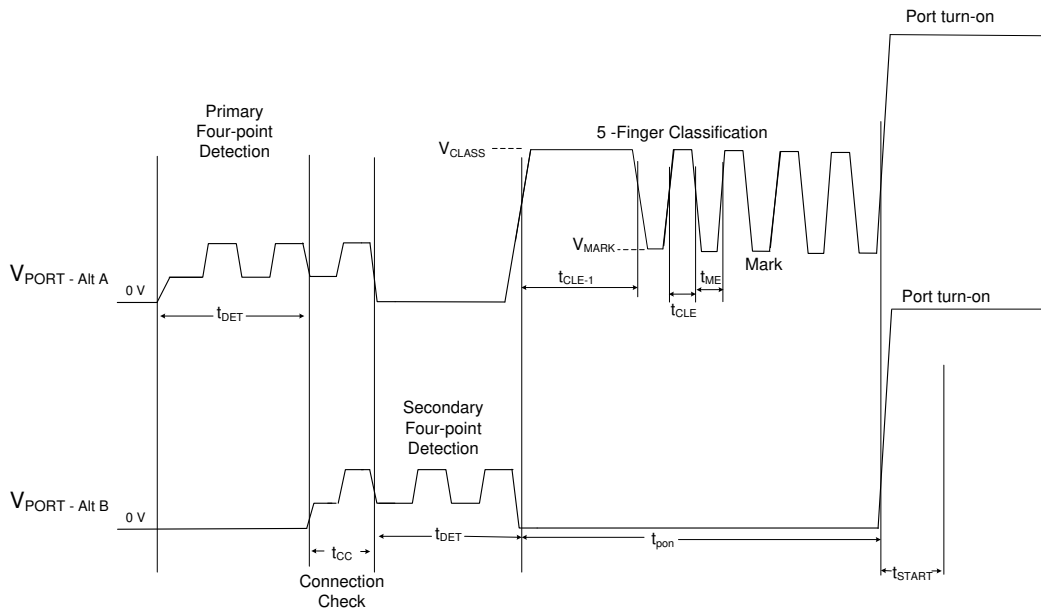


Figure 36. 4-Pair Single Signature Detection, 5-Event Classification and Turn On

Timing Diagrams (continued)

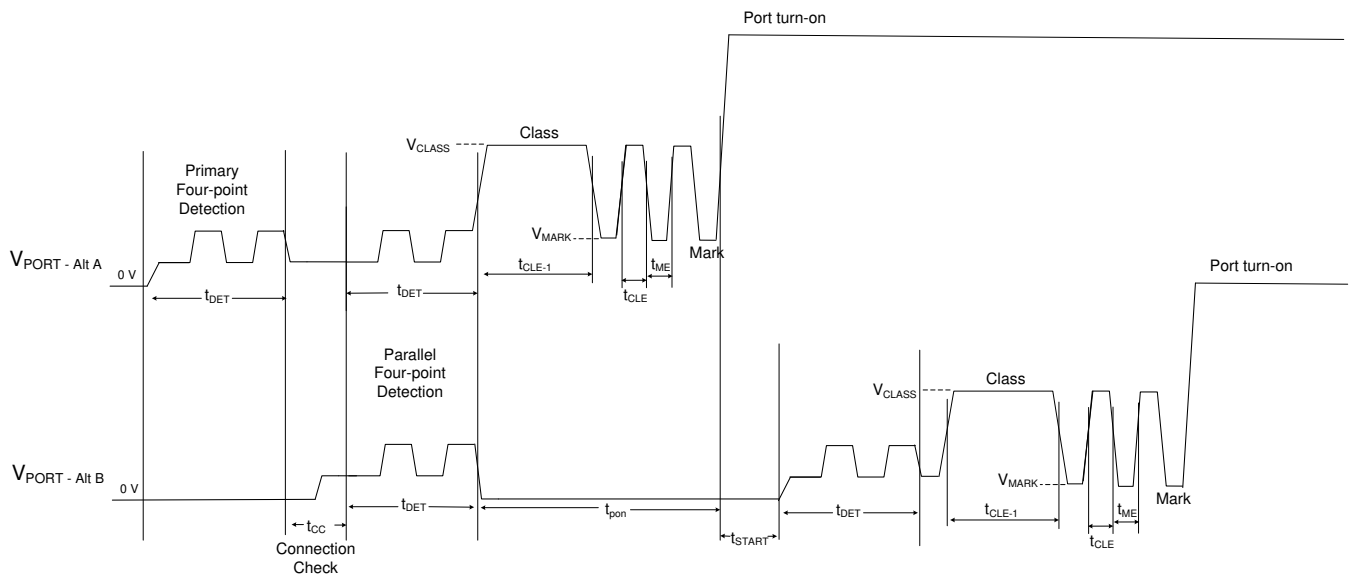


Figure 37. 4-Pair Dual Signature Detection, 3-Event Classification and Turn On

## 9 Detailed Description

### 9.1 Overview

The TPS23881 is an eight-channel PSE for power over Ethernet applications. Each of the eight channels provides detection, classification, protection, and shutdown in compliance with the IEEE 802.3bt standard.

Basic PoE features include the following:

- Performs high-reliability 4-point load detection
- Performs classification including type-3/4 (three, four or five -fingers) of up to Class 8 loads
- Recognizes single signature and dual signature PDs
- Enables power with protective fold-back current limiting, and an adjustable  $P_{CUT}$  threshold
- Shuts down during faults such as overcurrent or outputs shorts
- Performs a maintain power signature function to ensure power is removed if the load is disconnected
- Undervoltage lockout occurs if  $VPWR$  falls below  $V_{PUV\_F}$  (typical 26.5 V).

Enhanced features include the following:

- Programmable SRAM memory
- Dedicated 14-bit integrating current ADCs per port
- Port re-mapping capability
- 8- and 16-bit access mode selectable
- 1- and 3-bit port shutdown priority

#### 9.1.1 Operating Modes

##### 9.1.1.1 Auto

The port performs detection and classification (if valid detection occurs) continuously. Registers are updated each time a detection or classification occurs. The port power is automatically turned on based on the Power Allocation settings in register 0x29 if a valid classification is measured.

##### 9.1.1.2 Autonomous

Unlike Auto mode, which still requires a host to initialize the TPS23881 operation through a series of I<sup>2</sup>C commands, there is no host or I<sup>2</sup>C communication required when the device is in configured in Autonomous mode.

During power up, the resistance on the AUTO pin ( $R_{AUTO}$ ) is measured, and the device is pre-configured according to [Table 15](#). The port automatically performs detection and classification (if valid detection occurs) continuously on all ports. Port power is automatically turned on based on Power Allocation settings in register 0x29 if a valid classification is measured.

For applications that still require port telemetry, the I<sup>2</sup>C functionality is still supported in Autonomous mode.

---

#### NOTE

A 10 nF capacitor is required in parallel with  $R_{AUTO}$  to ensure stability in the Autonomous mode selection.

The Auto pin resistance ( $R_{AUTO}$ ) will not be measured following a device reset (assertion of the  $\overline{RESET}$  pin or RESAL bit in register 0x1A). The device will only measure ( $R_{AUTO}$ ) and pre-configure the internal registers during power up ( $V_{VPWR}$  and  $V_{VDD}$  rising above their respective UVLO thresholds).

---

## Overview (continued)

---

### NOTE

The device SRAM will need to be programmed in order to support applications that desire to remove a device from Autonomous mode after having initially powered up in Autonomous mode.

A device running from the internal ROM (SRAM unprogrammed) in Autonomous mode will turn off and automatically resume discovery and power on any valid loads following the assertion of the  $\overline{\text{RESET}}$  pin, I2C register 0x1A RESAL or RESPn bits, or a mode off command. Whereas a device running in Autonomous mode with the SRAM programmed will turn off and remain inactive until the host re-enables the port(s) through the I<sup>2</sup>C bus.

---

#### 9.1.1.3 Semiauto

The port performs detection and classification (if valid detection occurs) continuously. Registers are updated each time a detection or classification occurs. The port power is not automatically turned on. A Power Enable command is required to turn on the port.

#### 9.1.1.4 Manual/Diagnostic

***The use of this mode is intended for system diagnostic purposes only in the event that ports cannot be powered in accordance with the IEEE 802.3bt standard from Semiauto or Auto modes.***

The port performs the functions as configured in the registers. There is no automatic state change. Singular detection and classification measurements will be performed when commanded. Ports will be turned on immediately after a Power Enable command without any detection or classification measurements. Even though multiple classification events may be provided, the port voltage will reset immediately after the last finger, resetting the PD.

#### 9.1.1.5 Power Off

The port is powered off and does not perform a detection, classification, or power-on. In this mode, Status and Enable bits for the associated port are reset.



## Overview (continued)

### 9.1.2 Channel versus Port Terminology

Throughout this document the use of the terms *port* and *channel* will be used regularly, but these terms are **not interchangeable**. Instead the term *port* will be used to refer to the PSE PI (Power Interface), which is most commonly associated with a RJ45 connector, whereas the term *channel* will be used to refer to the individual power path or paths associated with each *port*.

Previous PSE devices commonly equated the number of controlled outputs as *ports* as each output would be dedicated to providing power on either the ALT-A or Alt-B pair set of a RJ45 jack/Ethernet port. However, with the adoption of 4-Pair power delivery sending power down both the ALT-A and ALT-B pair sets, there is now a need to differentiate between 2-pair and 4-pair capable PoE *ports*. Even more so, with the requirement to provide individual current limiting per pair set, any 4-pair *port* will now use two *channels* per 4-pair *port* to ensure safe and reliable delivery of power down each pair set.

As the TPS23881 is an 8-*channel* PSE controller. It can be configured to support up to eight 2-pair PoE *ports* or four 4-pair PoE *ports*, or any combination thereof where each 2-pair *port* accounts for one *channel*, and each 4-pair *port* accounts for 2 *channels*.

### 9.1.3 Requested Class versus Assigned Class

The *requested* class is the classification the PSE measures during mutual identification prior to turnon, whereas the *assigned* class is the classification level the channel was powered on with based on the power allocation setting in register 0x29h. In most cases where the power allocation equals or exceeds the *requested* class, the *requested* and *assigned* classes will be the same. However, in the case of power demotion, these values will differ.

For example: If a Class 8 PD is connected to a 60 W (Class 6) limited PSE port, the *requested* class reports "Class 8", while the *assigned* class reports "Class 6".

The **requested** classification results are available in registers 0x0C-0F

The **assigned** classification results are available in registers 0x4C-4F

---

#### NOTE

There is no Assigned Class assigned for ports/channels powered out of Manual/Diagnostic mode.

---

## Overview (continued)

### 9.1.4 Power Allocation and Power Demotion

The Power Allocation settings in register 0x29 sets the maximum power level a port will power on. Settings for each Class level from 2-pair 4 W (Class 1) up to 4-pair 90 W (Class 8) have been provided to maximize system design flexibility.

#### NOTE

The Power Allocation settings in register 0x29 do not set the power limit for a given port. The port and channel power limiting is configured with the 2P (registers 0x1E- x 21) and 4P (0x2A - x2B) policing registers

During a turn on attempt, if a PD presents a classification level greater than the power allocation setting for a port, the TPS23881 limits the number of classification fingers presented to the PD prior to turn on based on the power allocation settings in register 0x29. This behavior is called *Power Demotion* as it is the number of fingers presented to the PD that sets the maximum level of power the PD is allowed to draw before the PSE is allowed to disable it.

#### NOTE

Power Demotion on a port is limited to the Type boundaries as the only means of communication from the PSE to the PD is the number of classification fingers prior to turn on.

1 finger = 15.4 W, 3 fingers = 30 W, 4 fingers = 60 W, and 5 fingers = 90W

**Table 1. Single Signature PD Power Demotion Table**

Power Allocation Register 0x29	Assigned Class Value (based on the PD connected at the port)					
	Class 3 PD	Class 4 PD	Class 5 PD	Class 6 PD	Class 7 PD	Class 8 PD
4-Pair 15W	Class 3	Class 3	Class 3	Class 3	Class 3	Class 3
4-Pair 30W	Class 3	Class 4	Class 4	Class 4	Class 4	Class 4
4-Pair 45W	Class 3	Class 4	Class 5	<b>Class 4</b>	Class 5	Class 5
4-Pair 60W	Class 3	Class 4	Class 5	Class 6	Class 6	Class 6
4-Pair 75W	Class 3	Class 4	Class 5	Class 6	Class 7	<b>Class 6</b>
4-Pair 90W	Class 3	Class 4	Class 5	Class 6	Class 7	Class 8

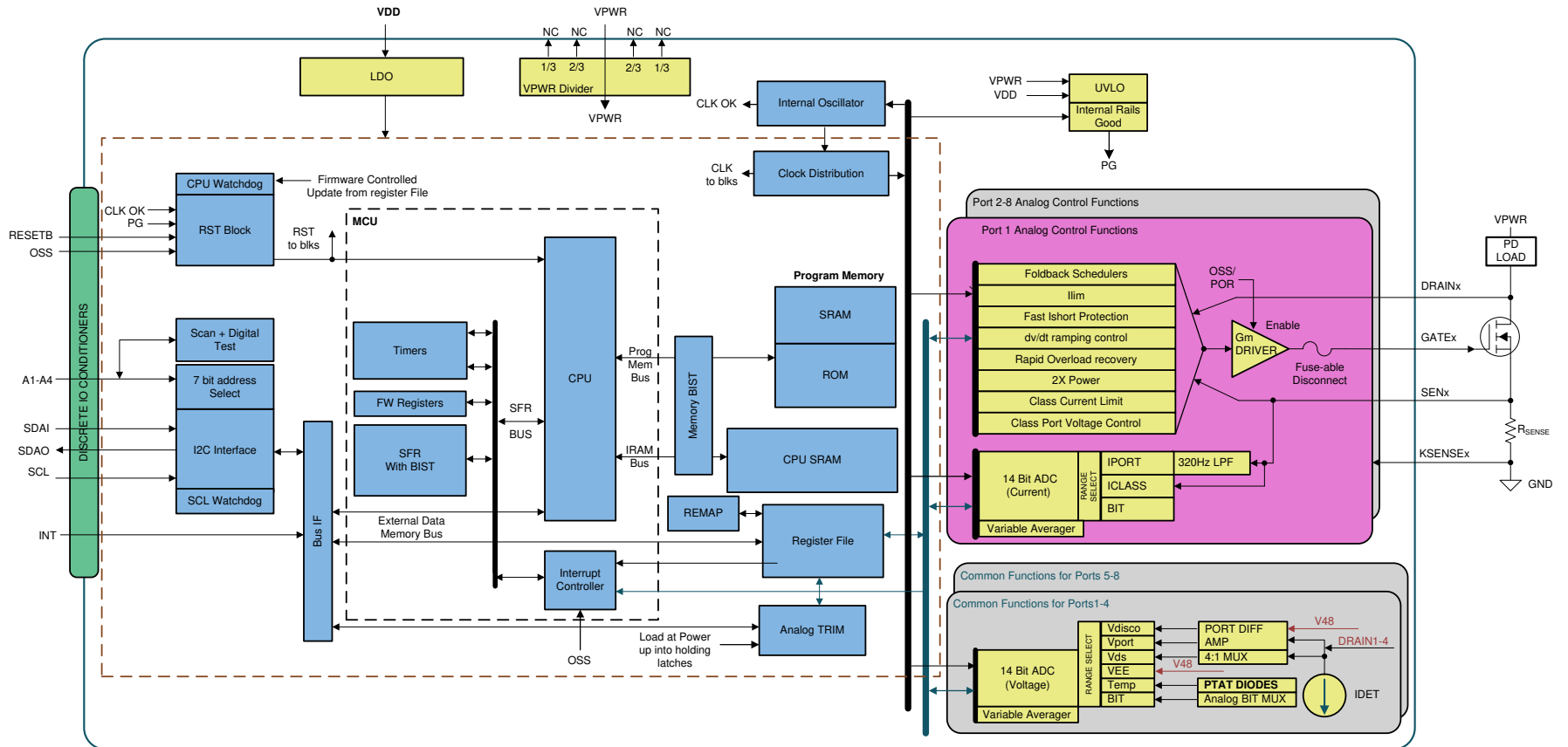
**Table 2. Dual Signature PD Power Demotion Table**

Power Allocation Register 0x29	Assigned Class Value (based on the PD connected at the port)					
	Class 3D PD		Class 4D PD		Class 5D PD	
	Odd Channel (Primary)	Even Channel (Secondary)	Odd Channel (Primary)	Even Channel (Secondary)	Odd Channel (Primary)	Even Channel (Secondary)
4-Pair 15W	Class 3	Insufficient Power	Class 3	Insufficient Power	Class 3	Insufficient Power
4-Pair 30W	Class 3	Class 3	Class 4	Insufficient Power	Class 4	Insufficient Power
4-Pair 45W	Class 3	Class 3	Class 4	Class 3	Class 5D	Insufficient Power
4-Pair 60W	Class 3	Class 3	Class 4	Class 4	Class 5D	Class 3
4-Pair 75W	Class 3	Class 3	Class 4	Class 4	Class 5D	Class 4
4-Pair 90W	Class 3	Class 3	Class 4	Class 4	Class 5D	Class 5D

#### NOTE

Class "X-D" Dual Signature PDs present as Class "X" on each alternative pairset. For example: a "Class 4D" PD would present as Class 4 on both the Alternative A and Alternative B pairsets.

## 9.2 Functional Block Diagram



## 9.3 Feature Description

### 9.3.1 Port Remapping

The TPS23881 provides port remapping capability, from the logical ports to the physical channels and pins.

The remapping is between any channel of a 4-port group (1 to 4, 5 to 8).

The following example is applicable to 0x26 register = 00111001, 00111001b.

- Logical port 1 (5) ↔ Physical channel 2 (6)
- Logical port 2 (6) ↔ Physical channel 3 (7)
- Logical port 3 (7) ↔ Physical channel 4 (8)
- Logical port 4 (8) ↔ Physical channel 1 (5)

#### NOTE

The device ignores any remapping command unless all four ports are in off mode.

If the TPS23881 receives an incorrect configuration, it ignores the incorrect configuration and retains the previous configuration. The ACK is sent as usual at the end of communication. For example, if the same remapping code is received for more than one port, then a read back of the Re-Mapping register (0x26) would be the last valid configuration.

Note that if an IC reset command (1Ah register) is received, the port remapping configuration is kept unchanged. However, if there is a Power-on Reset or if the RESET pin is activated, the Re-Mapping register is reinitialized to a default value.

### 9.3.2 Port Power Priority

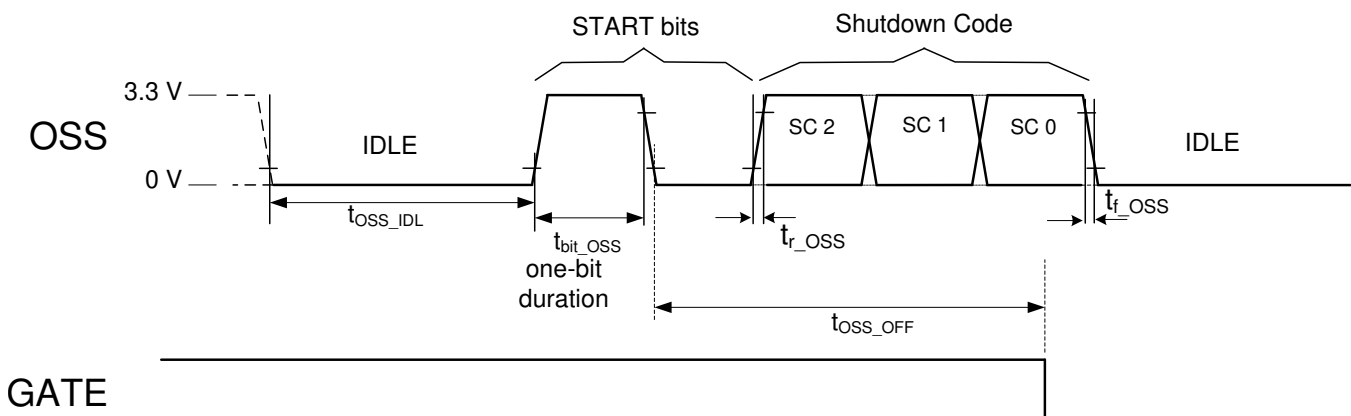
The TPS23881 supports 1- and 3-bit shutdown priority, which are selected with the MbitPrty bit of General Mask register (0x17).

The 1-bit shutdown priority works with the Port Power Priority (0x15) register. An OSSn bit with a value of 1 indicates that the corresponding port is treated as low priority, while a value of 0 corresponds to a high priority. As soon as the OSS input goes high, the low-priority ports are turned off.

The 3-bit shutdown priority works with the Multi Bit Power Priority (0x27/28) register, which holds the priority settings. A port with “000” code in this register has highest priority. Port priority reduces as the 3-bit value increases, with up to 8 priority levels. See [Figure 38](#).

The multi bit port priority implementation is defined as the following:

- OSS code ≤ Priority setting (0x27/28 register): Port is disabled
- OSS code > Priority setting (0x27/28 register): Port remains active



**Figure 38. Multi Bit Priority Port Shutdown if Lower-Priority Port**

## Feature Description (continued)

---

### NOTE

Prior to setting the MbitPrty bit from 0 to 1, make sure the OSS input is in the idle (low) state for a minimum of 200  $\mu$ s, to avoid any port misbehavior related to loss of synchronization with the OSS bit stream.

---

### NOTE

The OSS input has an internal 1- $\mu$ s to 5- $\mu$ s deglitch filter. From the idle state, a pulse with a longer duration is interpreted as a valid start bit. Ensure that the OSS signal is noise free.

---

### NOTE

To ensure both channels of a 4-pair port are disabled during and OSS event, make sure both channel have the same configurations in the 0x15 or 0x27/28 registers.

---

### 9.3.3 Analog-to-Digital Converters (ADC)

The TPS23881 features 10 multi-slope integrating converters. Each of the first eight converters is dedicated to current measurement for one channel and operate independently to perform measurements during classification and when the channel is powered on. When the channel is powered, the converter is used for current (100-ms averaged) monitoring, power policing, and DC disconnect. Each of the last two converters are shared within a group of four channels for discovery (16.6-ms averaged), port powered voltage monitoring, power-good status, and FET short detection. These converters are also used for general-purpose measurements including input voltage (1 ms) and die temperature.

The ADC type used in the TPS23881 differs from other similar types of converters in that the ADCs continuously convert while the input signal is sampled by the integrator, providing inherent filtering over the conversion period. The typical conversion time of the current converters is 800  $\mu$ s, while the conversion time is 1 ms for the other converters. Powered-device detection is performed by averaging 16 consecutive samples which provides significant rejection of noise at 50-Hz or 60-Hz line frequency. While a port is powered, digital averaging provides a channel current measurement integrated over a 100-ms time period. Note that an anti-aliasing filter is present for powered current monitoring.

---

### NOTE

During powered mode, current conversions are performed continuously. Also, in powered mode, the  $t_{\text{START}}$  timer must expire before any current or voltage ADC conversion can begin.

---

### 9.3.4 I<sup>2</sup>C Watchdog

An I<sup>2</sup>C Watchdog timer is available on the TPS23881 device. The timer monitors the I<sup>2</sup>C, SCL line for clock edges. When enabled, a timeout of the watchdog resets the I<sup>2</sup>C interface along with any active ports. This feature provides protection in the event of a hung software situation or I<sup>2</sup>C bus hang-up by slave devices. In the latter case, if a slave is attempting to send a data bit of 0 when the master stops sending clocks, then the slave may drive the data line low indefinitely. Because the data line is driven low, the master cannot send a STOP to clean up the bus. Activating the I<sup>2</sup>C watchdog feature of the TPS23881 clears this deadlocked condition. If the timer of two seconds expires, the ports latch off and the WD status bit is set. Note that WD Status will be set even if the watchdog is not enabled. The WD status bit may only be cleared by a device reset or writing a 0 to the WDS status bit location. The 4-bit watchdog disable field shuts down this feature when a code of 1011b is loaded. This field is preset to 1011b whenever the TPS23881 is initially powered. See [I<sup>2</sup>C WATCHDOG Register](#) for more details.

## Feature Description (continued)

### 9.3.5 Current Foldback Protection

The TPS23881 features two types of foldback mechanisms for complete MOSFET protection.

During inrush, at channel turn on, the foldback is based on the channel voltage as shown in [Figure 39](#). Note that the inrush current profile remains the same, regardless of the state of the 2x $F_{Bn}$  bits in register 0x40.

After the channel is powered and the Power Good is valid, a dual-slope operational foldback is used, providing protection against partial and total short-circuit at port output, while still being able to maintain the PD powered during normal transients at the PSE input voltage. Note that setting the 2x $F_{Bn}$  bit selects the 2x curve and clearing it selects the 1x curve. See [Figure 40](#).

In addition to the default foldback curves, the TPS23881 has individually enabled *alternative* foldback curves for both inrush and powered operation. These curves have been designed to accommodate certain loads that do not fully comply with the IEEE standard and requires additional power to be turned on or remain powered. See [Figure 39](#) and [Figure 40](#).

#### NOTE

If using the Alternative Foldback curves (ALTIR $_n$  or ALTFB $_n$  = 1), designers need to account for the additional power dissipation that can occur in the FETs under these conditions.

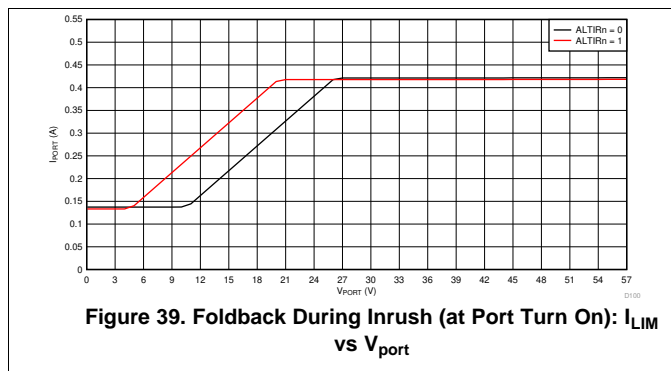


Figure 39. Foldback During Inrush (at Port Turn On):  $I_{LIM}$  vs  $V_{port}$

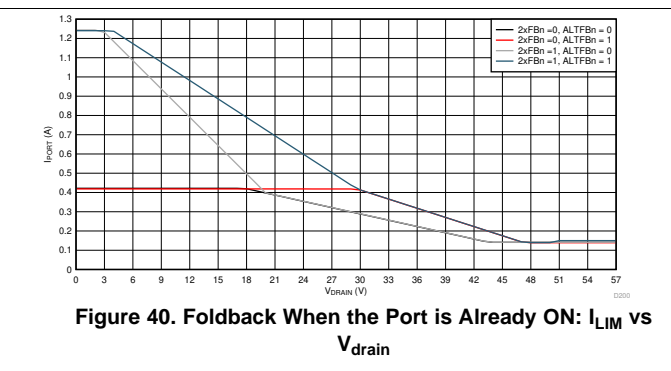


Figure 40. Foldback When the Port is Already ON:  $I_{LIM}$  vs  $V_{drain}$

## 9.4 Device Functional Modes

### 9.4.1 Detection

To eliminate the possibility of false detection, the TPS23881 uses a TI proprietary 4-point detection method to determine the signature resistance of the PD device. A false detection of a valid 25-k $\Omega$  signature can occur with 2-point detection type PSEs in noisy environments or if the load is highly capacitive.

Detection 1 and Detection 2 are merged into a single detection function which is repeated. Detection 1 applies I1 (160  $\mu$ A) to a channel, waits approximately 60 ms, then measures the channel voltage (V1) with the integrating ADC. Detection 2 then applies I2 (270  $\mu$ A) to the channel, waits another approximately 60 ms, then measures the channel voltage again (V2). The process is then repeated a second time to capture a third (V3) and fourth (V4) channel voltage measurements. Multiple comparisons and calculations are performed on all four measurement point combinations to eliminate the effects of a nonlinear or hysteretic PD signature. The resulting channel signature is then sorted into the appropriate category.

#### NOTE

The detection resistance measurement result is also available in the Channel Detect Resistance registers (0x44 - 0x47).

## Device Functional Modes (continued)

### 9.4.2 Connection Check

For 4-pair configured ports, the TPS23881 performs a connection check immediately after it measures a valid detection on either channel. During connection check both channels are probed to determine if a single signature or dual signature load is present on the port, and the results of this measurement are provided in the lower nibble (4 bits) of register 0x1C. The accurate determination of a single signature or dual signature is critical to the PSEs management of the port.

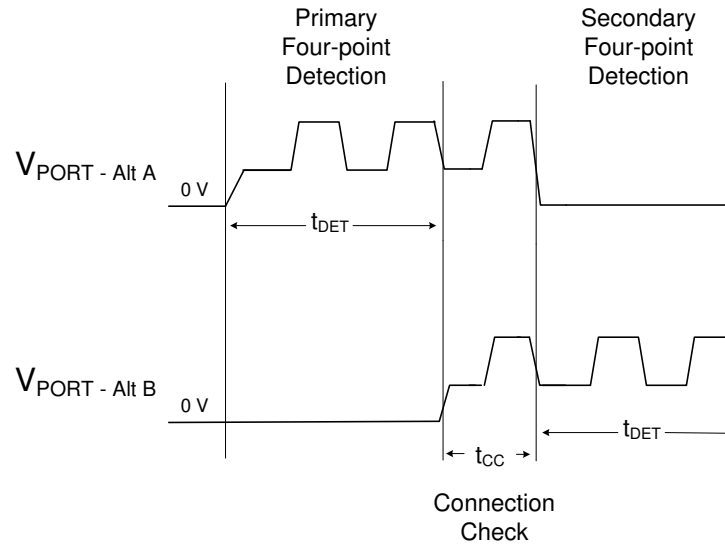


Figure 41. 4-Pair Port, Detection and Connection Check Waveforms with a Single Signature Load

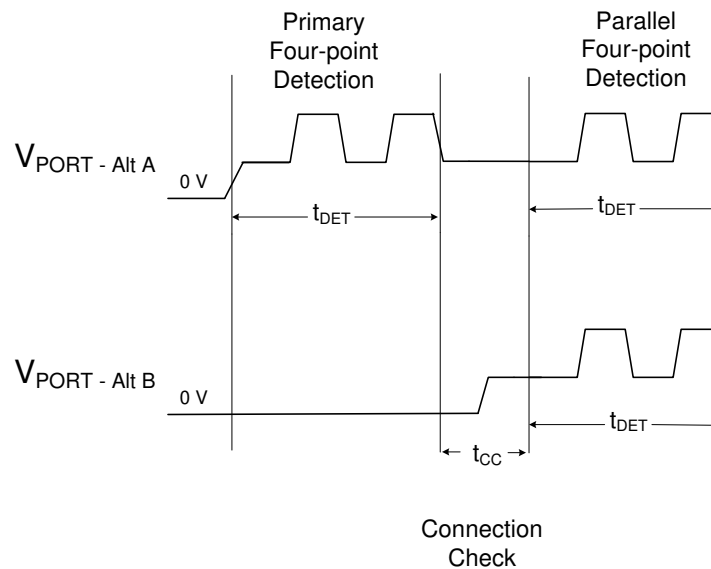


Figure 42. 4-Pair Port, Detection and Connection Check Waveforms with a Dual Signature Load

### 9.4.3 Classification

Hardware classification (class) is performed by supplying a voltage and sampling the resulting current. To eliminate the high power of a classification event from occurring in the power controller chip, the TPS23881 uses the external power FET for classification.

## Device Functional Modes (continued)

During classification, the voltage on the gate node of the external MOSFET is part of a linear control loop. The control loop applies the appropriate MOSFET drive to maintain a differential voltage between VPWR and DRAIN of 18.5 V. During classification the voltage across the sense resistor in the source of the MOSFET is measured and converted to a class level within the TPS23881. If a load short occurs during classification, the MOSFET gate voltage reduces to a linearly controlled, short-circuit value for the duration of the class event.

Classification results are read through the I<sup>2</sup>C Detection Event and Channel-n Discovery Registers. The TPS23881 also supports 1, 3, 4, or 5 finger classification for PDs ranging from Class 0 through Class 8, using the Power Enable and Port Power Allocation registers.

### 9.4.4 DC Disconnect

Disconnect is the automated process of turning off power to the port. When the port is unloaded or at least falls below minimum load, it is required to turn off power to the port and restart detection. In DC disconnect, the voltage across the sense resistors is measured. When enabled, the DC disconnect function monitors the sense resistor voltage of a powered port to verify the port is drawing at least the minimum current to remain active. The T<sub>DIS</sub> timer counts up whenever the port current is below the disconnect threshold (6.5 mA or 4.5 mA depending on the port configuration). If a timeout occurs, the port is shut down and the corresponding disconnect bit in the Fault Event Register is set. In the case of a PD implementing MPS (maintain Power Signature) current pulsing, the T<sub>DIS</sub> counter is reset each time the current goes continuously higher than the disconnect threshold for at least 3 ms.

The T<sub>DIS</sub> duration is set by the T<sub>MPDO</sub> Bits of the Timing Configuration register (0x16).

---

#### NOTE

If a Class 4 or lower 4-Pair Single Signature PD is connected, the TPS23881 will immediately power down one channel immediately after (no T<sub>MPDO</sub> timeout) the current falls below the disconnect threshold while leaving the second channel powered. This channel will be re-powered if the current on the remaining channel exceed 75mA. Alternatively if the current on the remaining channel falls below the disconnect threshold for longer than the T<sub>MPDO</sub> timeout, the port will be shut down and the corresponding disconnect bits in the Fault Event Register are set.

---



---

#### NOTE

If both channels of a 4-Pair Dual Signature PD are powered, the DCDCtx bit in register 0x2D is automatically set after turn on to ensure the IEEE compliant 4.5mA threshold is used.

---



---

#### NOTE

If a 4-Pair Single Signature Class 5-8 PD is powered, the DCDCtx bit in register 0x2D is automatically set after turn on to ensure the IEEE compliant 4.5mA threshold is used.

---

## 9.5 I<sup>2</sup>C Programming

### 9.5.1 I<sup>2</sup>C Serial Interface

The TPS23881 features a 3-wire I<sup>2</sup>C interface, using SDAI, SDAO, and SCL. Each transmission includes a START condition sent by the master, followed by the device address (7-bit) with R/W bit, a register address byte, then one or two data bytes and a STOP condition. The recipient sends an acknowledge bit following each byte transmitted. SDAI/SDAO is stable while SCL is high except during a START or STOP condition.

[Figure 43](#) and [Figure 44](#) show read and write operations through I<sup>2</sup>C interface, using configuration A or B (see [Table 25](#) for more details). The parametric read operation is applicable to ADC conversion results. The TPS23881 features quick access to the latest addressed register through I<sup>2</sup>C bus. When a STOP bit is received, the register pointer is not automatically reset.



### I<sup>2</sup>C Programming (continued)

It is also possible to perform a write operation to many TPS23881 devices at the same time. The slave address during this broadcast access is 0x7F, as shown in *PIN STATUS Register*. Depending on which configuration (A or B) is selected, a global write proceeds as following:

- Config A: Both 4-port devices (1 to 4 and 5 to 8) are addressed at same time.
- Config B: The whole device is addressed.

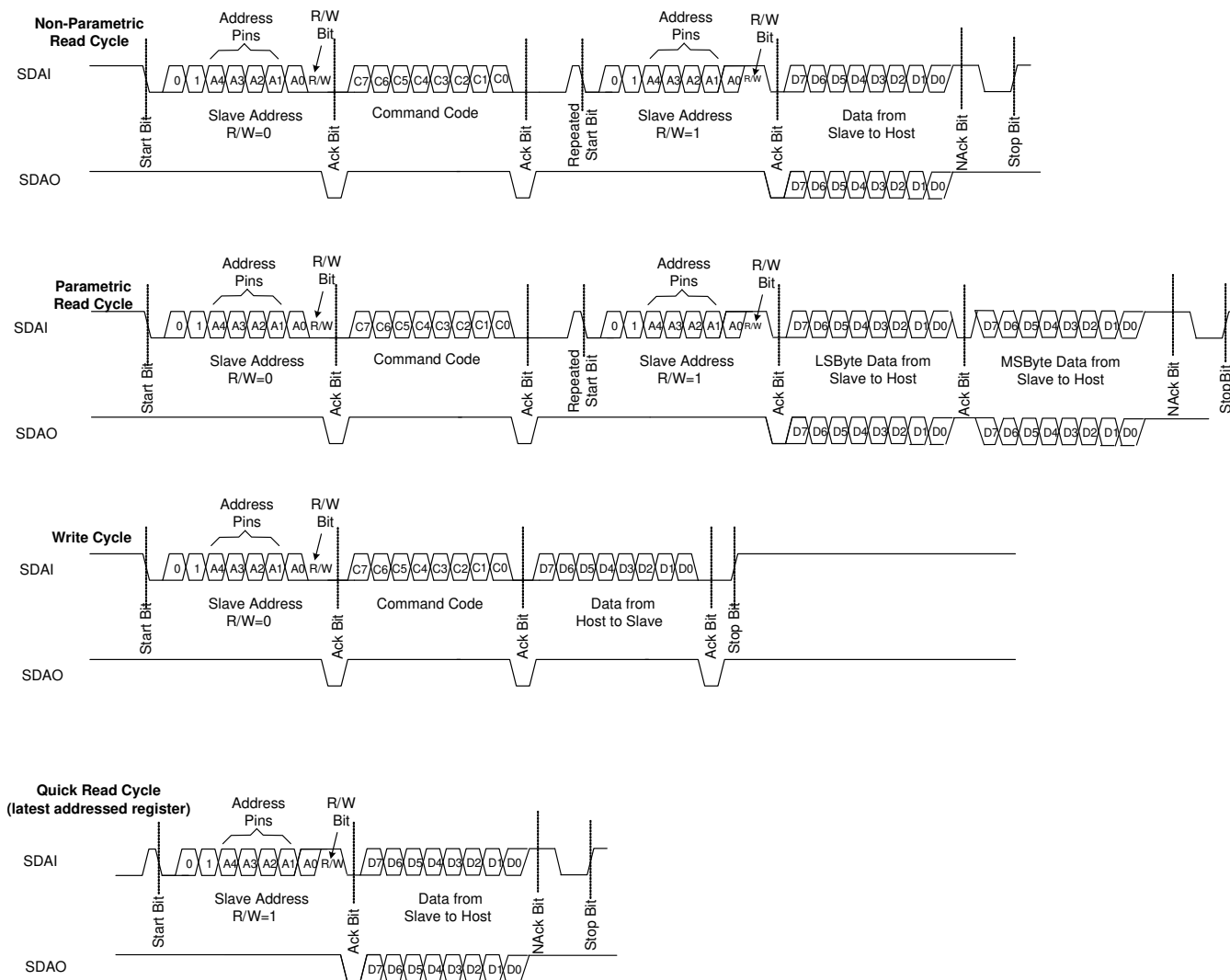


Figure 43. I<sup>2</sup>C interface Read and Write Protocol – Configuration A

### I<sup>2</sup>C Programming (continued)

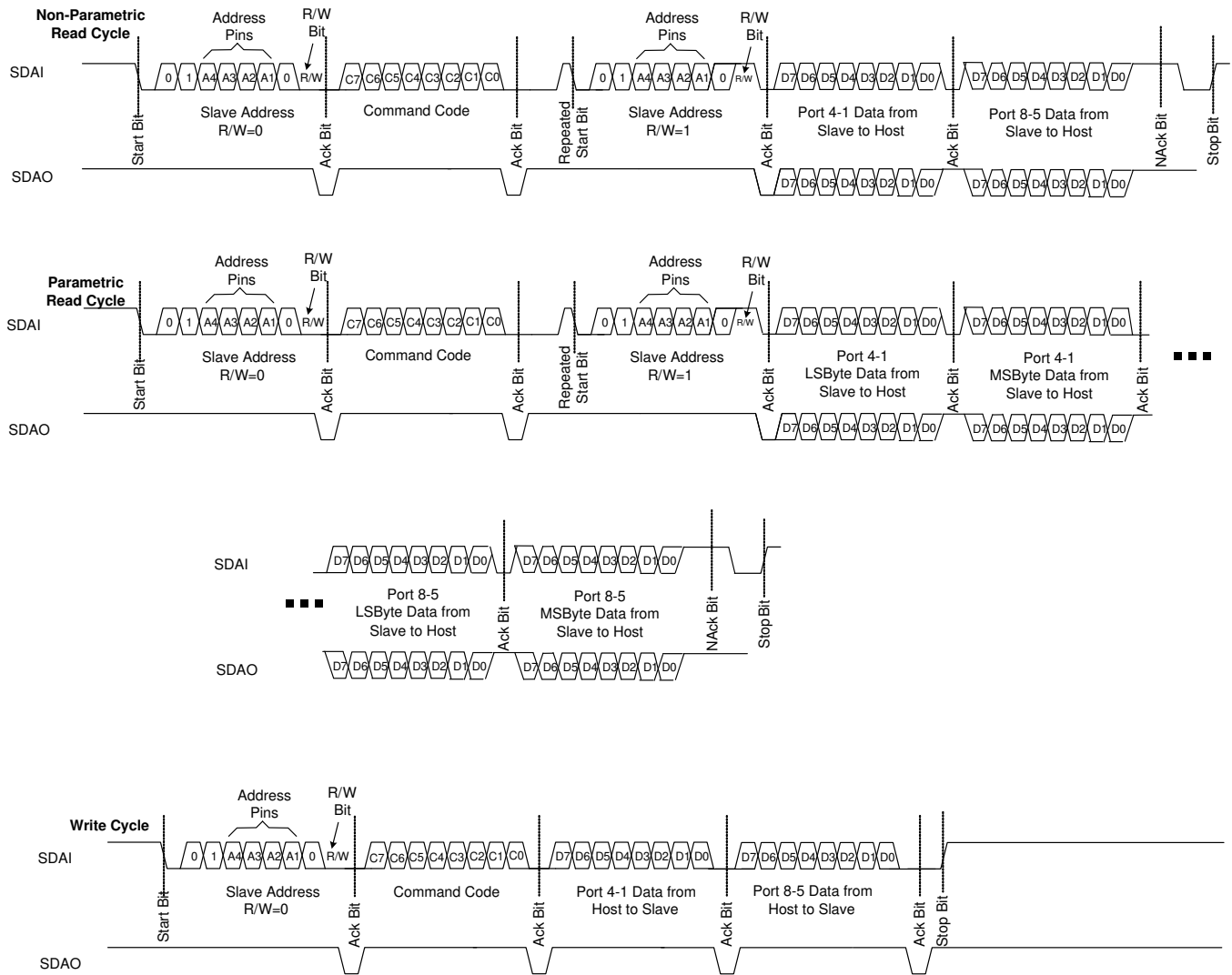


Figure 44. I<sup>2</sup>C interface Read and Write Protocol – Configuration B

## 9.6 Register Maps

### 9.6.1 Complete Register Set

**Table 3. Main Registers**

Cmd Code	Register or Command Name	I <sup>2</sup> C R/W	Data Byte	RST State	Bits Description							
<b>INTERRUPTS</b>												
00h	INTERRUPT	RO	1	1000,0000b <sup>(1)</sup>	SUPF	STRTF	IFAUULT	CLASC	DETC	DISF	PGC	PEC
01h	INTERRUPT MASK	R/W	1	1000,0000b 1110,0100b <sup>(2)</sup>	SUMSK	STMSK	IFMSK	CLMSK	DEMSK	DIMSK	PGMSK	PEMSK
<b>EVENT</b>												
02h	POWER EVENT	RO	1	0000,0000b	Power Good status change				Power Enable status change			
03h		CoR	1		PGC4	PGC3	PGC2	PGC1	PEC4	PEC3	PEC2	PEC1
04h	DETECTION EVENT	RO	1	0000,0000b	Classification				Detection			
05h		CoR	1		CLSC4	CLSC3	CLSC2	CLSC1	DETC4	DETC3	DETC2	DETC1
06h	FAULT EVENT	RO	1	0000,0000b	Disconnect occurred				PCUT fault occurred			
07h		CoR	1		DISF4	DISF3	DISF2	DISF1	PCUT4	PCUT3	PCUT2	PCUT1
08h	START/ILIM EVENT	RO	1	0000,0000b	ILIM fault occurred				START fault occurred			
09h		CoR	1		ILIM4	ILIM3	ILIM2	ILIM1	STRT4	STRT3	STRT2	STRT1
0Ah	SUPPLY/FAULT EVENT	RO	1	0111,0000b <sup>(3)</sup>	TSD	VDUV	VDWRN	VPUV	PCUT34	PCUT12	OSSE	RAMFLT
0Bh		CoR	1									
<b>STATUS</b>												
0Ch	CHANNEL 1 DISCOVERY	RO	1	0000,0000b	Requested CLASS Channel 1				DETECT Channel 1			
0Dh	CHANNEL 2 DISCOVERY	RO	1	0000,0000b	Requested CLASS Channel 2				DETECT Channel 2			
0Eh	CHANNEL 3 DISCOVERY	RO	1	0000,0000b	Requested CLASS Channel 3				DETECT Channel 3			
0Fh	CHANNEL 4 DISCOVERY	RO	1	0000,0000b	Requested CLASS Channel 4				DETECT Channel 4			
10h	POWER STATUS	RO	1	0000,0000b	PG4	PG3	PG2	PG1	PE4	PE3	PE2	PE1
11h	PIN STATUS	RO	1	AUTO,A[4:0],0,0	AUTO	SLA4	SLA3	SLA2	SLA1	SLA0	Rsvd	Rsvd
<b>CONFIGURATION</b>												
12h	OPERATING MODE	R/W	1	0000,0000b	Channel 4 Mode		Channel 3 Mode		Channel 2 Mode		Channel 1 Mode	
13h	DISCONNECT ENABLE	R/W	1	0000,1111b	Rsvd	Rsvd	Rsvd	Rsvd	DCDE4	DCDE3	DCDE2	DCDE1
14h	DETECT/CLASS ENABLE	R/W	1	0000,0000b	CLE4	CLE3	CLE2	CLE1	DETE4	DETE3	DETE2	DETE1
15h	PWRPR/PCUT DISABLE	R/W	1	0000,0000b	OSS4	OSS3	OSS2	OSS1	DCUT4	DCUT3	DCUT2	DCUT1
16h	TIMING CONFIG	R/W	1	0000,0000b	TLIM		TSTART		TOVLD		TMPDO	
17h	GENERAL MASK	R/W	1	1000,0000b	INTEN	Rsvd	nbitACC	MbitPrty	CLCHE	DECHE	Rsvd	

- (1) SUPF bit reset state shown is at Power up only
- (2) Register 0x01 is initialized to 0xE4h if the device powers up in Autonomous mode
- (3) VDUV, VPUV and VDWRN bits reset state shown is at Power up only

**Register Maps (continued)**
**Table 3. Main Registers (continued)**

Cmd Code	Register or Command Name	I <sup>2</sup> C R/W	Data Byte	RST State	Bits Description							
<b>PUSH BUTTONS</b>												
18h	DETECT/CLASS Restart	WO	1	0000,0000b	RCL4	RCL3	RCL2	RCL1	RDET4	RDET3	RDET2	RDET1
19h	POWER ENABLE	WO	1	0000,0000b	POFF4	POFF3	POFF2	POFF1	PWON4	PWON3	PWON2	PWON1
1Ah	RESET	WO	1	0000,0000b	CLRAIN	CLINP	Rsvd	RESAL	RESP4	RESP3	RESP2	RESP1
<b>GENERAL/SPECIALIZED</b>												
1Bh	ID	RO	1	0101,0101b	MFR ID				IC Version			
1Ch	AUTOCLASS and CONNECTION CHECK	RO	1	0000,0000b	AC4	AC3	AC2	AC1	CC34_2	CC34_1	CC12_2	CC12_1
1Dh	RESERVED	R/W	1	0000,0000b	Rsvd							
1Eh	2P POLICE 1 CONFIG	R/W	1	1111,1111b	2-Pair POLICE Channel 1							
1Fh	2P POLICE 2 CONFIG	R/W	1	1111,1111b	2-Pair POLICE Channel 2							
20h	2P POLICE 3 CONFIG	R/W	1	1111,1111b	2-Pair POLICE Channel 3							
21h	2P POLICE 4 CONFIG	R/W	1	1111,1111b	2-Pair POLICE Channel 4							
22h	CAP MEASUREMENT <sup>(4)</sup>	R/W	1	0000,0000b	Rsvd	CDET4	Rsvd	CDET3	Rsvd	CDET2	Rsvd	CDET1
23h	Reserved	R/W	1	0000,0000b	Rsvd	Rsvd	Rsvd	Rsvd	Rsvd	Rsvd	Rsvd	Rsvd
24h	Power-on FAULT	RO	1	0000,0000b	PF Channel 4		PF Channel 3		PF Channel 2		PF Channel 1	
25h		CoR	1									
26h	RE-MAPPING	R/W	1	1110,0100b	Physical re-map Logical Port 4	Physical re-map Logical Port 3	Physical re-map Logical Port 2	Physical re-map Logical Port 1				
27h	Multi-Bit Priority 21	R/W	1	0000,0000b	Rsvd	Channel 2		Rsvd	Channel 1			
28h	Multi-Bit Priority 43	R/W	1	0000,0000b	Rsvd	Channel 4		Rsvd	Channel 3			
29h	Port Power Allocation	R/W	1	0000,0000b	4P34	MC34		4P12	MC12			
2Ah	4P POLICE 12 CONFIG	R/W	1	1111,1111b	4-Pair POLICE Channels 1 and 2							
2Bh	4P POLICE 34 CONFIG	R/W	1	1111,1111b	4-Pair POLICE Channels 3 and 4							
2Ch	TEMPERATURE	RO	1	0000,0000b	Temperature (bits 7 to 0)							
2Dh	4P FAULT CONFIG	R/W	1	0000,0000b	NLM34	NLM12	NCT34	NCT12	4PPCT34	4PPCT12	DCDT34	DCDT12
2Eh	INPUT VOLTAGE	RO	2	0000,0000b	Input Voltage: LSByte							
2Fh		RO		0000,0000b	Rsvd	Rsvd	Input Voltage: MSByte (bits 13 to 8)					
<b>EXTENDED REGISTER SET – PARAMETRIC MEASUREMENT</b>												
30h	Channel 1 CURRENT	RO	2	0000,0000b	Channel 1 Current: LSByte							
31h		RO		0000,0000b	Rsvd	Rsvd	Channel 1 Current: MSByte (bits 13 to 8)					
32h	Channel 1 VOLTAGE	RO	2	0000,0000b	Channel 1 Voltage: LSByte							
33h		RO		0000,0000b	Rsvd	Rsvd	Channel 1 Voltage: MSByte (bits 13 to 8)					

(4) Capacitance Measurement is only supported if SRAM code is programmed

**Table 4. Main Registers**

Cmd Code	Register or Command Name	I <sup>2</sup> C R/W	Data Byte	RST State	Bits Description							
34h	Channel 2 CURRENT	RO	2	0000,0000b	Channel 2 Current: LSByte							
35h		RO		0000,0000b	Rsvd	Rsvd	Channel 2 Current: MSByte (bits 13 to 8)					
36h	Channel 2 VOLTAGE	RO	2	0000,0000b	Channel 2 Voltage: LSByte							
37h		RO		0000,0000b	Rsvd	Rsvd	Channel 2 Voltage: MSByte (bits 13 to 8)					
38h	Channel 3 CURRENT	RO	2	0000,0000b	Channel 3 current: LSByte							
39h		RO		0000,0000b	Rsvd	Rsvd	Channel 3 Current: MSByte (bits 13 to 8)					
3Ah	Channel 3 VOLTAGE	RO	2	0000,0000b	Channel 3 Voltage: LSByte							
3Bh		RO		0000,0000b	Rsvd	Rsvd	Channel 3 Voltage: MSByte (bits 13 to 8)					
3Ch	Channel 4 CURRENT	RO	2	0000,0000b	Channel 4 current: LSByte							
3Dh		RO		0000,0000b	Rsvd	Rsvd	Channel 4 Current: MSByte (bits 13 to 8)					
3Eh	Channel 4 VOLTAGE	RO	2	0000,0000b	Channel 4 Voltage: LSByte							
3Fh		RO		0000,0000b	Rsvd	Rsvd	Channel 4 Voltage: MSByte (bits 13 to 8)					
<b>CONFIGURATION/OTHERS</b>												
40h	CHANNEL FOLDBACK	R/W	1	0000,0000b	2xFB4	2xFB3	2xFB2	2xFB1	Rsvd	Rsvd	Rsvd	Rsvd
41h	FIRMWARE REVISION	RO	1	RRRR,RRRRb	Firmware Revision							
42h	I2C WATCHDOG	R/W	1	0001,0110b	Rsvd	Rsvd	Rsvd	Watchdog Disable				WDS
43h	DEVICE ID	RO	1	0010,0010b	Device ID number				Silicon Revision number			
<b>SIGNATURE MEASUREMENTS</b>												
44h	Ch1 DETECT RESISTANCE	RO	1	0000,0000b	Channel 1 Resistance							
45h	Ch2 DETECT RESISTANCE	RO	1	0000,0000b	Channel 2 Resistance							
46h	Ch3 DETECT RESISTANCE	RO	1	0000,0000b	Channel 3 Resistance							
47h	Ch4 DETECT RESISTANCE	RO	1	0000,0000b	Channel 4 Resistance							
48h	Ch1 CAP MEASUREMENT <sup>(1)</sup>	RO	1	0000,0000b	Channel 1 Capacitance							
49h	Ch2 CAP MEASUREMENT <sup>(1)</sup>	RO	1	0000,0000b	Channel 2 Capacitance							
4Ah	Ch3 CAP MEASUREMENT <sup>(1)</sup>	RO	1	0000,0000b	Channel 3 Capacitance							
4Bh	Ch4 CAP MEASUREMENT <sup>(1)</sup>	RO	1	0000,0000b	Channel 4 Capacitance							

(1) Capacitance Measurement is only supported if SRAM code is programmed

**Table 4. Main Registers (continued)**

Cmd Code	Register or Command Name	I <sup>2</sup> C R/W	Data Byte	RST State	Bits Description							
<b>ASSIGNED CHANNEL STATUS</b>												
4Ch	ASSIGNED CLASS CHANNEL 1	RO	1	0000,0000b	Assigned CLASS Channel 1				Previous CLASS Channel 1			
4Dh	ASSIGNED CLASS CHANNEL 2	RO	1	0000,0000b	Assigned CLASS Channel 2				Previous CLASS Channel 2			
4Eh	ASSIGNED CLASS CHANNEL 3	RO	1	0000,0000b	Assigned CLASS Channel 3				Previous CLASS Channel 3			
4Fh	ASSIGNED CLASS CHANNEL 4	RO	1	0000,0000b	Assigned CLASS Channel 4				Previous CLASS Channel 4			
<b>AUTOCLASS CONFIGURATION/MEASUREMENTS</b>												
50h	AUTOCLASS CONTROL	R/W	1	0000,0000b	MAC4	MAC3	MAC2	MAC1	AAC4	AAC3	AAC2	AAC1
51h	CHANNEL 1 AUTOCLASS PWR	RO	1	0000,0000b	Rsrvd	Channel 1 AutoClass Power						
52h	CHANNEL 2 AUTOCLASS PWR	RO	1	0000,0000b	Rsrvd	Channel 2 AutoClass Power						
53h	CHANNEL 3 AUTOCLASS PWR	RO	1	0000,0000b	Rsrvd	Channel 3 AutoClass Power						
54h	CHANNEL 4 AUTOCLASS PWR	RO	1	0000,0000b	Rsrvd	Channel 4 AutoClass Power						
<b>MISCELLANEOUS</b>												
55h	ALTERNATIVE FOLDBACK	R/W	1	0000,0000b	ALTFB4	ALTFB3	ALTFB2	ALTFB1	ALTIR4	ALTIR3	ALTIR2	ALTIR1
56h - 5Fh	RESERVED	R/W	1	0000,0000b	Rsrvd	Rsrvd	Rsrvd	Rsrvd	Rsrvd	Rsrvd	Rsrvd	Rsrvd
<b>SRAM</b>												
60h	SRAM CONTROL	R/W	1	0000,0000b	PROG_SEL	CPU_RST	Rsrvd	PAR_EN	RAM_EN	PAR_SEL	RZ/W	CLR_PTR
61h	SRAM DATA	R/W	-	-	SRAM DATA - Read and Write (continuous)							
62h	START ADDRESS	R/W	1	0000,0000b	Programming Start Address (LSB)							
63h		R/W	1	0000,0000b	Programming Start Address (MSB)							
64h - 6Fh	RESERVED	R/W	1	0000,0000b	Rsrvd	Rsrvd	Rsrvd	Rsrvd	Rsrvd	Rsrvd	Rsrvd	Rsrvd

## 9.6.2 Detailed Register Descriptions

### 9.6.2.1 INTERRUPT Register

COMMAND = 00h with 1 Data Byte, Read only

Active high, each bit corresponds to a particular event that occurred. Each bit can be individually reset by doing a read at the corresponding event register address, or by setting bit 7 of Reset register.

Any active bit of Interrupt register activates the  $\overline{\text{INT}}$  output if its corresponding Mask bit in INTERRUPT Mask register (01h) is set, as well as the INTEN bit in the General Mask register.

**Figure 45. INTERRUPT Register Format**

7	6	5	4	3	2	1	0
SUPF	STRTF	IFAULT	CLASC	DETC	DISF	PGC	PEC
R-1	R-0	R-0	R-0	R-0	R-0	R-0	R-0

LEGEND: R/W = Read/Write; R = Read only; -n = value after reset

**Table 5. INTERRUPT Register Field Descriptions**

Bit	Field	Type	Reset	Description
7	SUPF	R	1	Indicates that a Supply Event Fault or SRAM memory fault occurred SUPF = TSD    VDUV    VDWRN    VPUV    RAMFLT 1 = At least one Supply Event Fault or SRAM memory fault occurred 0 = No such event occurred
6	STRTF	R	0	Indicates that a $t_{\text{START}}$ Fault occurred on at least one channel. STRTF = STRT1    STRT2    STRT3    STRT4 1 = $t_{\text{START}}$ Fault occurred for at least one channel 0 = No $t_{\text{START}}$ Fault occurred
5	IFAULT	R	0	Indicates that a $t_{\text{OVLd}}$ or $t_{\text{LIM}}$ Fault occurred on at least one channel. IFAULT = PCUT1    PCUT2    PCUT3    PCUT4    PCUT34    PCUT12    ILIM1    ILIM2    ILIM3    ILIM4 1 = $t_{\text{OVLd}}$ and/or $t_{\text{LIM}}$ Fault occurred for at least one channel 0 = No $t_{\text{OVLd}}$ nor $t_{\text{LIM}}$ Fault occurred
4	CLASC	R	0	Indicates that at least one classification cycle occurred on at least one channel CLASC = CLSC1    CLSC2    CLSC3    CLSC4 1 = At least one classification cycle occurred for at least one channel 0 = No classification cycle occurred
3	DETC	R	0	Indicates that at least one detection cycle occurred on at least one channel DETC = DETC1    DETC2    DETC3    DETC4 1 = At least one detection cycle occurred for at least one channel 0 = No detection cycle occurred
2	DISF	R	0	Indicates that a disconnect event occurred on at least one channel. DISF = DISF1    DISF2    DISF3    DISF4 1 = Disconnect event occurred for at least one channel 0 = No disconnect event occurred
1	PGC	R	0	Indicates that a power good status change occurred on at least one channel. PGC = PGC1    PGC2    PGC3    PGC4 1 = Power good status change occurred on at least one channel 0 = No power good status change occurred
0	PEC	R	0	Indicates that a power enable status change occurred on at least one channel PEC = PEC1    PEC2    PEC3    PEC4 1 = Power enable status change occurred on at least one channel 0 = No power enable status change occurred

**9.6.2.2 INTERRUPT MASK Register**

COMMAND = 01h with 1 Data Byte, Read/Write

Each bit corresponds to a particular event or fault as defined in the Interrupt register.

Writing a 0 into a bit will mask the corresponding event/fault from activating the  $\overline{\text{INT}}$  output.

Note that the bits of the Interrupt register always change state according to events or faults, regardless of the state of the state of the Interrupt Mask register.

Note that the INTEN bit of the General Mask register must also be set in order to allow an event to activate the INT output.

**Figure 46. INTERRUPT MASK Register Format**

7	6	5	4	3	2	1	0
SUMSK	STMSK	IFMSK	CLMSK	DEMSK	DIMSK	PGMSK	PEMSK
R/W-1	R/W-0	R/W-0	R/W-0	R/W-0	R/W-0	R/W-0	R/W-0

LEGEND: R/W = Read/Write; R = Read only; -n = value after reset

**Table 6. INTERRUPT MASK Register Field Descriptions**

Bit	Field	Type	Reset	Description
7	SUMSK	R/W	1	Supply Event Fault mask bit. 1 = Supply Event Fault will activate the $\overline{\text{INT}}$ output. 0 = Supply Event Fault will have no impact on $\overline{\text{INT}}$ output.
6	STMSK	R/W	0	$t_{\text{START}}$ Fault mask bit. 1 = $t_{\text{START}}$ Fault will activate the $\overline{\text{INT}}$ output. 0 = $t_{\text{START}}$ Fault will have no impact on $\overline{\text{INT}}$ output.
5	IFMSK	R/W	0	$t_{\text{OVL D}}$ or $t_{\text{LIM}}$ Fault mask bit. 1 = $t_{\text{OVL D}}$ and/or $t_{\text{LIM}}$ Fault occurrence will activate the $\overline{\text{INT}}$ output 0 = $t_{\text{OVL D}}$ and/or $t_{\text{LIM}}$ Fault occurrence will have no impact on $\overline{\text{INT}}$ output
4	CLMSK	R/W	0	Classification cycle mask bit. 1 = Classification cycle occurrence will activate the $\overline{\text{INT}}$ output. 0 = Classification cycle occurrence will have no impact on $\overline{\text{INT}}$ output.
3	DEMSK	R/W	0	Detection cycle mask bit. 1 = Detection cycle occurrence will activate the $\overline{\text{INT}}$ output. 0 = Detection cycle occurrence will have no impact on $\overline{\text{INT}}$ output.
2	DIMSK	R/W	0	Disconnect event mask bit. 1 = Disconnect event occurrence will activate th $\overline{\text{INT}}$ output. 0 = Disconnect event occurrence will have no impact on $\overline{\text{INT}}$ output.
1	PGMSK	R/W	0	Power good status change mask bit. 1 = Power good status change will activate the $\overline{\text{INT}}$ output. 0 = Power good status change will have no impact on $\overline{\text{INT}}$ output.
0	PEMSK	R/W	0	Power enable status change mask bit. 1 = Power enable status change will activate the $\overline{\text{INT}}$ output. 0 = Power enable status change will have no impact on $\overline{\text{INT}}$ output.

**NOTE**

The contents of this register initializes to 0xE4 upon power up if the device is configured in Autonomous mode with a valid  $R_{\text{AUTO}}$  resistor connected to the AUTO pin.



### 9.6.2.3 POWER EVENT Register

COMMAND = 02h with 1 Data Byte, Read only

COMMAND = 03h with 1 Data Byte, Clear on Read

Active high, each bit corresponds to a particular event that occurred.

Each bit xxx1-4 represents an individual channel.

A read at each location (02h or 03h) returns the same register data with the exception that the Clear on Read command clears all bits of the register.

If this register is causing the  $\overline{\text{INT}}$  pin to be activated, this Clear on Read will release the  $\overline{\text{INT}}$  pin.

Any active bit will have an impact on the Interrupt register as indicated in the Interrupt register description.

**Figure 47. POWER EVENT Register Format**

7	6	5	4	3	2	1	0
PGC4	PGC3	PGC2	PGC1	PEC4	PEC3	PEC2	PEC1
R-0	R-0	R-0	R-0	R-0	R-0	R-0	R-0
CR-0	CR-0	CR-0	CR-0	CR-0	CR-0	CR-0	CR-0

LEGEND: R/W = Read/Write; R = Read only; ; CR = Clear on Read, -n = value after reset

**Table 7. POWER EVENT Register Field Descriptions**

Bit	Field	Type	Reset	Description
7–4	PGC4–PGC1	R or CR	0	Indicates that a power good status change occurred. 1 = Power good status change occurred 0 = No power good status change occurred
3–0	PEC4–PEC1	R or CR	0	Indicates that a power enable status change occurred. 1 = Power enable status change occurred 0 = No power enable status change occurred

#### NOTE

For 4-pair wired Ports, the PECn bits will be updated **individually** as status changes for each channel.

For 4-Pair **Single Signature** devices, the PGCn bits will be set only after the status has changed on both channels. This is done to prevent the possible scenario of dual interrupts as the second Channel completes processing shortly after the first.

For 4-Pair **Dual Signature** devices, the PECn and PGCn bits will be set as the status changes on each channel.

**9.6.2.4 DETECTION EVENT Register**

COMMAND = 04h with 1 Data Byte, Read only

COMMAND = 05h with 1 Data Byte, Clear on Read

Active high, each bit corresponds to a particular event that occurred.

Each bit xxx1-4 represents an individual channel.

A read at each location (04h or 05h) returns the same register data with the exception that the Clear on Read command clears all bits of the register. These bits are cleared when channel-n is turned off.

If this register is causing the  $\overline{INT}$  pin to be activated, this Clear on Read will release the  $\overline{INT}$  pin.

Any active bit will have an impact on the Interrupt register as indicated in the Interrupt register description.

**Figure 48. DETECTION EVENT Register Format**

7	6	5	4	3	2	1	0
CLSC4	CLSC3	CLSC2	CLSC1	DETC4	DETC3	DETC2	DETC1
R-0	R-0	R-0	R-0	R-0	R-0	R-0	R-0
CR-0	CR-0	CR-0	CR-0	CR-0	CR-0	CR-0	CR-0

LEGEND: R/W = Read/Write; R = Read only; ; CR = Clear on Read, -n = value after reset

**Table 8. DETECTION EVENT Register Field Descriptions**

Bit	Field	Type	Reset	Description
7–4	CLSC4–CLSC1	R or CR	0	Indicates that at least one classification cycle occurred if the CLCHE bit in General Mask register is low. Conversely, it indicates when a change of class occurred if the CLCHE bit is set.  1 = At least one classification cycle occurred (if CLCHE = 0) or a change of class occurred (CLCHE = 1) 0 = No classification cycle occurred (if CLCHE = 0) or no change of class occurred (CLCHE = 1)
3–0	DETC4–DETC1	R or CR	0	Indicates that at least one detection cycle occurred if the DECHE bit in General Mask register is low. Conversely, it indicates when a change in detection occurred if the DECHE bit is set.  1 = At least one detection cycle occurred (if DECHE = 0) or a change in detection occurred (DECHE = 1) 0 = No detection cycle occurred (if DECHE = 0) or no change in detection occurred (DECHE = 1)

**NOTE**

For 4-Pair operated ports without a pending PWON command, these bits will be set only after the status is ready for **both** channels. This is done to prevent the possible scenario of dual interrupts as the second channel completes processing after the first.

The DETCn bits will only be set concurrently within 5ms of completing detection and connection check on **both** channels

For a 4-pair **single signature** device, the CLSCn bit will only be set for the pair set that classification was completed on even though the requested class will be given for both channels in registers 0x0C-0F.

For a 4-pair **dual signature** device only doing discovery in Semi-auto mode, the CLSCn bits will be set **concurrently** within 5ms of classification being completed on **both** channels. In manual mode, the CLSCn bits will be set **individually** within 5ms of classification being completed on **each** channels.

For 4-pair **dual signature** devices with a pending PWON command or in Auto mode, the DETCn and CLSCn bits will be set independently as each channel completes its portion of discovery during the dual-signature staggered turn on procedure.

### 9.6.2.5 FAULT EVENT Register

COMMAND = 06h with 1 Data Byte, Read only

COMMAND = 07h with 1 Data Byte, Clear on Read

Active high, each bit corresponds to a particular event that occurred.

Each bit xxx1-4 represents an individual channel.

A read at each location (06h or 07h) returns the same register data with the exception that the Clear on Read command clears all bits of the register. These bits are cleared when channel-n is turned off.

If this register is causing the  $\overline{\text{INT}}$  pin to be activated, this Clear on Read will release the  $\overline{\text{INT}}$  pin.

Any active bit will have an impact on the Interrupt register as indicated in the Interrupt register description.

**Figure 49. FAULT EVENT Register Format**

7	6	5	4	3	2	1	0
DISF4	DISF3	DISF2	DISF1	PCUT4	PCUT3	PCUT2	PCUT1
R-0	R-0	R-0	R-0	R-0	R-0	R-0	R-0
CR-0	CR-0	CR-0	CR-0	CR-0	CR-0	CR-0	CR-0

LEGEND: R/W = Read/Write; R = Read only; ; CR = Clear on Read, -n = value after reset

**Table 9. FAULT EVENT Register Field Descriptions**

Bit	Field	Type	Reset	Description
7–4	DISF4–DISF1	R or CR	0	Indicates that a disconnect event occurred. 1 = Disconnect event occurred 0 = No disconnect event occurred
3–0	PCUT4–PCUT1	R or CR	0	Indicates that a $t_{\text{OVL D}}$ Fault occurred. 1 = $t_{\text{OVL D}}$ Fault occurred 0 = No $t_{\text{OVL D}}$ Fault occurred

#### NOTE

For 4-pair wired ports, the DISFn and PCUTn bits will be updated **individually** as status changes for each channel.

Disconnect events for 4-Pair single signature devices will set **both** corresponding bits, whereas 4-pair dual signature devices will have independent disconnect events per channel.

In the event a singular channel of a 4-pair dual signature device is turned off due to a Disconnect or 2-Pair PCut fault, power may be reapplied to that channel by setting the PWON bit in 0x19h provided the detection and classification are still valid and the Power Allocation settings in 0x29 are sufficient based on the assigned classification of the powered channel.

If PCUT is disabled for a channel, this channel will **not** be automatically turned off during a PCUT fault condition. However, the PCUT fault flag will still be operational, with a fault timeout equal to  $t_{\text{OVL D}}$ .

Clearing a PCUT event has no impact on the TLIM or TOVLD counters.

### 9.6.2.6 START/ILIM EVENT Register

COMMAND = 08h with 1 Data Byte, Read only

COMMAND = 09h with 1 Data Byte, Clear on Read

Active high, each bit corresponds to a particular event that occurred.

Each bit xxx1-4 represents an individual channel.

A read at each location (08h or 09h) returns the same register data with the exception that the Clear on Read command clears all bits of the register. These bits are cleared when channel-n is turned off.

If this register is causing the  $\overline{INT}$  pin to be activated, this Clear on Read will release the  $\overline{INT}$  pin.

Any active bit will have an impact on the Interrupt register as indicated in the Interrupt register description.

**Figure 50. START/ILIM EVENT Register Format**

7	6	5	4	3	2	1	0
ILIM4	ILIM3	ILIM2	ILIM1	STRT4	STRT3	STRT2	STRT1
R-0	R-0	R-0	R-0	R-0	R-0	R-0	R-0
CR-0	CR-0	CR-0	CR-0	CR-0	CR-0	CR-0	CR-0

LEGEND: R/W = Read/Write; R = Read only; ; CR = Clear on Read, -n = value after reset

**Table 10. START/ILIM EVENT Register Field Descriptions**

Bit	Field	Type	Reset	Description
7–4	ILIM4–ILIM1	R or CR	0	Indicates that a $t_{LIM}$ fault occurred, which means the channel has limited its output current to $I_{LIM}$ or the folded back $I_{LIM}$ for more than $t_{LIM}$ . 1 = $t_{LIM}$ fault occurred 0 = No $t_{LIM}$ fault occurred
3–0	STRT4–STRT1	R or CR	0	Indicates that a $t_{START}$ fault occurred during turn on. 1 = $t_{START}$ fault or class/detect error occurred 0 = No $t_{START}$ fault or class/detect error occurred

#### NOTE

For 4-pair wired Ports:

The ILIMn bits will be updated **individually** as the status changes for each channel.

The STRTn bits will be updated **individually** as the status changes for each channel

When a Start Fault is reported and the PECn bit in Power Event register is set, then there is an Inrush fault.

When a Start Fault is reported and the PECn bit is **not** set, then the Power-On Fault register (0x24h) will indicate the cause of the fault.

In AUTO mode, STRTn faults will not be reported and register 0x24h will not be updated due to invalid discovery results.

In the event a singular channel of a 4-pair dual signature PD is turned off due to a ILIM fault or STRT fault, power may be reapplied to that channel by setting the PWON bit in 0x19h provided the detection and classification are still valid and the Power Allocation settings in 0x29 are sufficient based on the assigned classification of the powered channel.

**Inrush Fault (STRtn) Handling on 4-Pair wired ports:**

For 4-pair wired ports with single signature PDs connected, the inrush behavior will vary based on assigned classification given during turn on:

For 4P SS PD with an assigned classification of Class 6 or lower:

One channel will go through inrush while the second channel remains idle

If no STRT fault is detected at the end of inrush, the second channel will immediately turn on, and the PGn bits will be set

If a STRT fault **is** detected at the end of inrush, the secondary channel will remain off and the primary will be disabled, and a 1 sec cool-down period will be initiated on **both** channels. Both STRtn bits will be set.

For 4P SS PD with an assigned classification of Class 7 or 8:

Both channels will go through inrush in parallel

If no STRT fault is detected at the end of inrush on either channel, the PGn bits will be set and the port will remain powered.

If a STRT fault **is** detected at the end of inrush on **either** channel, **both** channels will be disabled, and a 1 sec cool-down period will be initiated on both channels. Both STRtn bits will be set.

For 4-pair wired ports with dual signature PDs connected, both channel will operate independent of the other. Each will do perform inrush control during startup and if either channel faults, the remaining channel will be unaffected.

### 9.6.2.7 SUPPLY and FAULT EVENT Register

COMMAND = 0Ah with 1 Data Byte, Read only

COMMAND = 0Bh with 1 Data Byte, Clear on Read

Active high, each bit corresponds to a particular event that occurred.

A read at each location (0Ah or 0Bh) returns the same register data with the exception that the Clear on Read command clears all bits of the register.

If this register is causing the  $\overline{\text{INT}}$  pin to be activated, this Clear on Read will release the  $\overline{\text{INT}}$  pin.

Any active bit will have an impact on the Interrupt register as indicated in the Interrupt register description.

**Figure 51. SUPPLY and FAULT EVENT Register Format**

7	6	5	4	3	2	1	0
TSD	VDUV	VDWRN	VPUV	PCUT34	PCUT12	OSSE	RAMFLT
R	R	R	R	R	R	R	R
CR	CR	CR	CR	CR	CR	CR	CR

LEGEND: R/W = Read/Write; R = Read only; ; CR = Clear on Read, -n = value after reset

**Table 11. SUPPLY and FAULT EVENT Register Field Descriptions**

Bit	Field	Type	POR/ RST	Description
7	TSD	R or CR	0 / P	Indicates that a thermal shutdown occurred. When there is thermal shutdown, all channels are turned off and are put in OFF mode. The TPS23881 internal circuitry continues to operate however, including the ADCs. Note that at as soon as the internal temperature has decreased below the low threshold, the channels can be turned back ON regardless of the status of the TSD bit.  1 = Thermal shutdown occurred 0 = No thermal shutdown occurred
6	VDUV	R or CR	1 / P	Indicates that a VDD UVLO occurred.  1 = VDD UVLO occurred 0 = No VDD UVLO occurred
5	VDWRN	R or CR	1 / P	Indicates that the VDD has fallen under the UVLO warning threshold.  1 = VDD UV Warning occurred 0 = No VDD UV warning occurred
4	VPUV	R or CR	1 / P	Indicates that a VPWR undervoltage occurred.  1 = VPWR undervoltage occurred 0 = No VPWR undervoltage occurred
3	PCUT34	R or CR	0 / 0	Indicates that a 4-Pair Summed PCUT fault occurred on channels 3 and 4.  1 = 4-Pair Summed PCUT fault occurred on channels 3 and 4 0 = No Summed PCUT fault occurred
2	PCUT12	R or CR	0 / 0	Indicates that a 4-Pair Summed PCUT fault occurred on channels 1 and 2.  1 = 4-Pair Summed PCUT fault occurred on channels 1 and 2 0 = No Summed PCUT fault occurred
1	OSSE	R or CR	0 / 0	Indicates that an OSS Event occurred  1 = one or more channels with a group of 4 were disabled due to the assertion of the OSS pin or provided 3-bit OSS code 0 = No OSS events occurred
0	RAMFLT	R or CR	0 / 0	Indicates that a SRAM fault has occurred  1 = SRAM fault occurred 0 = No SRAM fault occurred

---

**NOTE**

The RST condition of "P" indicates that the previous state of these bits will be preserved following a device reset using the  $\overline{\text{RESET}}$  pin. Thus, pulling the  $\overline{\text{RESET}}$  input low will not clear the TSD, VDUV, VDWRN, or VPUV bits.

---

**NOTE**

While the VPUV bit is set, any PWONn commands will be ignored until  $V_{VPWR} > 30\text{ V}$ .

During VPUV undervoltage condition, the Detection Event register (CLSCn, DETCn) is not cleared, unless VPWR also falls below the VPWR UVLO falling threshold (approximately 18 V).

A clear on Read will not effectively clear VDUV bit as long as the VPWR undervoltage condition is maintained.

---

**NOTE**

In 1-bit mode (MbitPrty = 0 in reg 0x17), the OSSE bit will be set anytime a channel within a group of 4 has OSS enabled and the OSS pin is asserted.

In 3-bit mode (MbitPrty = 1 in reg 0x17), the OSSE bit will be set anytime a 3-bit priority code is sent that is equal to or greater than the MBPn settings in registers 0x27 and 0x28 channel for a group of 4 channels.

---

For a 4-pair wired port, if 4P PCUT is disabled (4PPCTxx = 0 in 0x2D), the port will not be automatically turned off during a 4P-PCUT fault condition. However, the PCUTnn fault bits will still be operational, with a fault timeout equal to  $t_{OVL D}$ . Also, if a Clear on Read is done at the Fault Event register, the PCUTnn bit is reset, and the associated summed PCUT counter is reset. Only the Channels reporting such interrupt have their counter cleared by the CoR operation. Also, clearing a PCUT fault has no impact on TLIM counter.

#### 9.6.2.7.1 Detected SRAM Faults and "Safe Mode"

The TPS23881 is configured with internal SRAM memory fault monitoring, and in the event that an error is detected with the SRAM memory, the device will enter "safe mode". While in "Safe mode" the FW Revision value in register 0x41 will be set to 0xFFh.

Any channels that are currently powered will remain powered, but the majority of the operation will be disabled until the SRAM can be reloaded. The device UVLO and Thermal Shutdown features in addition to the disconnect and current foldback functions for the powered channels will be preserved in "safe mode".

Any channels that were not powered prior to the SRAM fault detection will be set to OFF mode (see register 0x12h description for additional changes that will occur as a result of the change to OFF mode). Port Remapping (0x26h) and any other channel configuration settings (ie Power Allocation 0x29h) will be preserved.

Upon detection of a SRAM fault the "RAM\_EN" bit in 0x60 will be cleared and the RAMFLT bit will be set in register 0x0A. The internal firmware will continue to run in "safe mode" until this bit is set again by the host after the SRAM is reloaded or a POR (Power on Reset) event occurs. In order to ensure a smooth transition into and out of "safe mode", any I2C commands other than those to reprogram the SRAM need to be deferred until after the SRAM is reloaded and determined to be "valid" (see register 0x60 SRAM programming descriptions).

---

#### NOTE

Once set, the RAMFLT bit will remain set even after the device is removed from safe mode. It is recommended that this bit be cleared prior to setting the RAM\_EN bit in register 0x60 following the SRAM reload.

---

#### NOTE

The PAR\_EN bit in reg 0x60 must be set and the corresponding SRAM\_Parity code (available for download from the [TI mySecure Software](#) webpage) must be loaded into the device in order for the SRAM fault monitoring to be active.

Please refer to the [How to Load TPS2388x SRAM Code](#) document for more information on the recommended SRAM programming procedure.

---

##### 9.6.2.7.1.1 ULA (Ultra Low Alpha) Package Option: TPS23881A

Over time, SRAM faults may occur due to alpha-induced 'soft-errors' from the naturally occurring Alpha particles in the atmosphere or semiconductor packaging itself. If enough of these Alpha particles are collected in the memory structure of the silicon, the cumulative electrical charge of these particles can flip the state of one or more logic gates.

To minimize the potential for these alpha-induced SRAM faults, users can choose to use the TPS23881A package option which has a specialized ULA (Ultra Low Alpha) packaging mold compound that reduces the silicon's exposure to Alpha particles by a factor of roughly 10x.



### 9.6.2.8 CHANNEL 1 DISCOVERY Register

COMMAND = 0Ch with 1 Data Byte, Read Only

**Figure 52. CHANNEL 1 DISCOVERY Register Format**

7	6	5	4	3	2	1	0
REQUESTED CLASS Ch1				DETECT Ch1			
R-0	R-0	R-0	R-0	R-0	R-0	R-0	R-0

LEGEND: R/W = Read/Write; R = Read only; -n = value after reset

### 9.6.2.9 CHANNEL 2 DISCOVERY Register

COMMAND = 0Dh with 1 Data Byte, Read Only

**Figure 53. CHANNEL 2 DISCOVERY Register Format**

7	6	5	4	3	2	1	0
REQUESTED CLASS Ch2				DETECT Ch2			
R-0	R-0	R-0	R-0	R-0	R-0	R-0	R-0

LEGEND: R/W = Read/Write; R = Read only; -n = value after reset

### 9.6.2.10 CHANNEL 3 DISCOVERY Register

COMMAND = 0Eh with 1 Data Byte, Read Only

**Figure 54. CHANNEL 3 DISCOVERY Register Format**

7	6	5	4	3	2	1	0
REQUESTED CLASS Ch3				DETECT Ch3			
R-0	R-0	R-0	R-0	R-0	R-0	R-0	R-0

LEGEND: R/W = Read/Write; R = Read only; -n = value after reset

### 9.6.2.11 CHANNEL 4 DISCOVERY Register

COMMAND = 0Fh with 1 Data Byte, Read Only

**Figure 55. CHANNEL 4 DISCOVERY Register Format**

7	6	5	4	3	2	1	0
REQUESTED CLASS Ch4				DETECT Ch4			
R-0	R-0	R-0	R-0	R-0	R-0	R-0	R-0

LEGEND: R/W = Read/Write; R = Read only; -n = value after reset

**Bit Descriptions:** These bits represent the most recent "requested" classification and detection results for channel n. These bits are cleared when channel n is turned off.

**Table 12. CHANNEL n DISCOVERY Register Field Descriptions**

Bit	Field	Type	Reset	Description																																																																																					
7–4	RCLASS Ch-n	R	0	Most recent classification result on channel n. The selection is as following: <table border="1" data-bbox="516 346 1305 940"> <thead> <tr> <th colspan="4">RCLASS Ch-n</th> <th>Requested Class</th> </tr> </thead> <tbody> <tr><td>0</td><td>0</td><td>0</td><td>0</td><td>Unknown</td></tr> <tr><td>0</td><td>0</td><td>0</td><td>1</td><td>Class 1</td></tr> <tr><td>0</td><td>0</td><td>1</td><td>0</td><td>Class 2</td></tr> <tr><td>0</td><td>0</td><td>1</td><td>1</td><td>Class 3</td></tr> <tr><td>0</td><td>1</td><td>0</td><td>0</td><td>Class 4</td></tr> <tr><td>0</td><td>1</td><td>0</td><td>1</td><td>Reserved – read as Class 0</td></tr> <tr><td>0</td><td>1</td><td>1</td><td>0</td><td>Class 0</td></tr> <tr><td>0</td><td>1</td><td>1</td><td>1</td><td>Class Overcurrent</td></tr> <tr><td>1</td><td>0</td><td>0</td><td>0</td><td>Class 5 - 4-Pair Single Signature</td></tr> <tr><td>1</td><td>0</td><td>0</td><td>1</td><td>Class 6 - 4-Pair Single Signature</td></tr> <tr><td>1</td><td>0</td><td>1</td><td>0</td><td>Class 7 - 4-Pair Single Signature</td></tr> <tr><td>1</td><td>0</td><td>1</td><td>1</td><td>Class 8 - 4-Pair Single Signature</td></tr> <tr><td>1</td><td>1</td><td>0</td><td>0</td><td>Class 4+ - Type-1 Limited</td></tr> <tr><td>1</td><td>1</td><td>0</td><td>1</td><td>Class 5 - 4-Pair Dual Signature</td></tr> <tr><td>1</td><td>1</td><td>1</td><td>0</td><td>Reserved</td></tr> <tr><td>1</td><td>1</td><td>1</td><td>1</td><td>Class Mismatch</td></tr> </tbody> </table>	RCLASS Ch-n				Requested Class	0	0	0	0	Unknown	0	0	0	1	Class 1	0	0	1	0	Class 2	0	0	1	1	Class 3	0	1	0	0	Class 4	0	1	0	1	Reserved – read as Class 0	0	1	1	0	Class 0	0	1	1	1	Class Overcurrent	1	0	0	0	Class 5 - 4-Pair Single Signature	1	0	0	1	Class 6 - 4-Pair Single Signature	1	0	1	0	Class 7 - 4-Pair Single Signature	1	0	1	1	Class 8 - 4-Pair Single Signature	1	1	0	0	Class 4+ - Type-1 Limited	1	1	0	1	Class 5 - 4-Pair Dual Signature	1	1	1	0	Reserved	1	1	1	1	Class Mismatch
RCLASS Ch-n				Requested Class																																																																																					
0	0	0	0	Unknown																																																																																					
0	0	0	1	Class 1																																																																																					
0	0	1	0	Class 2																																																																																					
0	0	1	1	Class 3																																																																																					
0	1	0	0	Class 4																																																																																					
0	1	0	1	Reserved – read as Class 0																																																																																					
0	1	1	0	Class 0																																																																																					
0	1	1	1	Class Overcurrent																																																																																					
1	0	0	0	Class 5 - 4-Pair Single Signature																																																																																					
1	0	0	1	Class 6 - 4-Pair Single Signature																																																																																					
1	0	1	0	Class 7 - 4-Pair Single Signature																																																																																					
1	0	1	1	Class 8 - 4-Pair Single Signature																																																																																					
1	1	0	0	Class 4+ - Type-1 Limited																																																																																					
1	1	0	1	Class 5 - 4-Pair Dual Signature																																																																																					
1	1	1	0	Reserved																																																																																					
1	1	1	1	Class Mismatch																																																																																					
3–0	DETECT Ch-n	R	0	Most recent detection result on channel n. The selection is as following: <table border="1" data-bbox="516 1031 1305 1377"> <thead> <tr> <th colspan="4">DETECT Ch-n</th> <th>Detection Status</th> </tr> </thead> <tbody> <tr><td>0</td><td>0</td><td>0</td><td>0</td><td>Unknown</td></tr> <tr><td>0</td><td>0</td><td>0</td><td>1</td><td>Short-circuit</td></tr> <tr><td>0</td><td>0</td><td>1</td><td>0</td><td>Reserved</td></tr> <tr><td>0</td><td>0</td><td>1</td><td>1</td><td>Too Low</td></tr> <tr><td>0</td><td>1</td><td>0</td><td>0</td><td>Valid</td></tr> <tr><td>0</td><td>1</td><td>0</td><td>1</td><td>Too High</td></tr> <tr><td>0</td><td>1</td><td>1</td><td>0</td><td>Open Circuit</td></tr> <tr><td>0</td><td>1</td><td>1</td><td>1</td><td>Reserved</td></tr> <tr><td>1</td><td>1</td><td>1</td><td>0</td><td>MOSFET fault</td></tr> </tbody> </table>	DETECT Ch-n				Detection Status	0	0	0	0	Unknown	0	0	0	1	Short-circuit	0	0	1	0	Reserved	0	0	1	1	Too Low	0	1	0	0	Valid	0	1	0	1	Too High	0	1	1	0	Open Circuit	0	1	1	1	Reserved	1	1	1	0	MOSFET fault																																			
DETECT Ch-n				Detection Status																																																																																					
0	0	0	0	Unknown																																																																																					
0	0	0	1	Short-circuit																																																																																					
0	0	1	0	Reserved																																																																																					
0	0	1	1	Too Low																																																																																					
0	1	0	0	Valid																																																																																					
0	1	0	1	Too High																																																																																					
0	1	1	0	Open Circuit																																																																																					
0	1	1	1	Reserved																																																																																					
1	1	1	0	MOSFET fault																																																																																					

“Requested” vs. “Assigned” Classification: The “requested” class is the classification the PSE measures during Mutual Identification prior to turn on, whereas the “assigned” class is the classification level the channel was powered on with based on the Power Allocation setting in register 0x29h. The “assigned” classification values are available in registers 0x4C-4F

---

**NOTE**

Due to the need to power on after 1 class finger, the "Class 4+ - Type 1 Limited" Requested Class is reported anytime a Class 4 or higher PD is powered with register 0x29 configured for 15.5W.

For a 4-pair single signature device, both channels will report the requested PD classification within 5ms after classification is completed. However, only the channel that classification was measured on will have the CLSCn bit set in register 0x04h

For a 4-pair dual signature device each channel will reports its own individually requested PD classification within 5ms after classification is completed on each Channel

Upon being powered, devices that present a class 0 signature during discovery will be given an assigned class of "Class 3"

In Manual/Diagnostic mode, Class 8 4-pair single signature loads will be reported as "Class 5DS" when classification is only enabled on one channel.

---

### 9.6.2.12 POWER STATUS Register

COMMAND = 10h with 1 Data Byte, Read only

Each bit represents the actual power status of a channel.

Each bit xx1-4 represents an individual channel.

These bits are cleared when channel-n is turned off, including if the turn off is caused by a fault condition.

**Figure 56. POWER STATUS Register Format**

7	6	5	4	3	2	1	0
PG4	PG3	PG2	PG1	PE4	PE3	PE2	PE1
R-0	R-0	R-0	R-0	R-0	R-0	R-0	R-0

LEGEND: R/W = Read/Write; R = Read only; -n = value after reset

**Table 13. POWER STATUS Register Field Descriptions**

Bit	Field	Type	Reset	Description
7–4	PG4–PG1	R	0	Each bit, when at 1, indicates that the channel is on and that the voltage at DRAINn pin has gone below the power good threshold during turn on. These bits are latched high once the turn on is complete and can only be cleared when the channel is turned off or at RESET/POR.  1 = Power is good 0 = Power is not good
3–0	PE4–PE1	R	0	Each bit indicates the ON/OFF state of the corresponding channel.  1 = Channel is on 0 = Channel is off

For 4-pair wired ports, these bits will be updated individually as the status changes for each channel

For 4-Pair Single Signature devices, the PGN bits will be set only after the status has changed on both channels. This is done to prevent the possible scenario of dual interrupts as the second channel completes processing after the first.

For 4-Pair Dual Signature devices, the PECn and PGCn bits will be set as the status changes on each channel.

**9.6.2.13 PIN STATUS Register**

COMMAND = 11h with 1 Data Byte, Read Only

**Figure 57. PIN STATUS Register Format**

7	6	5	4	3	2	1	0
AUTO	SLA4	SLA3	SLA2	SLA1	SLA0	0	0
AUTO pin	A4 pin	A3 pin	A2 pin	A1 pin	0/1 <sup>(1)</sup>	0	0

LEGEND: R/W = Read/Write; R = Read only; -n = value after reset

(1) If Configuration A, it can be 0 or 1. If configuration B, it is 0.

**Table 14. PIN STATUS Register Field Descriptions**

Bit	Field	Type	Reset	Description
7	AUTO	R	AUTO	Autonomous mode enabled bit. 0 = Autonomous mode disabled (AUTO pin floating) 1 = Autonomous mode enabled (Valid resistance connected between Auto pin and GND) Note: This bit will only be set in the lower I2C register set (channel 1-4).
6-3	SLA4-SLA1	R	See above	I <sup>2</sup> C device address, as defined while using pins A4-A1.
2	SLA0	R		SLA0 bit is internally defined to 0 or 1 0 = Channel 1-4 1 = Channels 5-8

DESCRIPTION	BINARY DEVICE ADDRESS							ADDRESS PINS			
	6	5	4	3	2	1	0	A4	A3	A2	A1
Broadcast access	1	1	1	1	1	1	1	X	X	X	X
Slave 0	0	1	0	0	0	0	0/1	GND	GND	GND	GND
	0	1	0	0	0	1	0/1	GND	GND	GND	HIGH
	0	1	0	0	1	0	0/1	GND	GND	HIGH	GND
	0	1	0	0	1	1	0/1	GND	GND	HIGH	HIGH
	0	1	0	1	0	0	0/1	GND	HIGH	GND	GND
	0	1	0	1	0	1	0/1	GND	HIGH	GND	HIGH
	0	1	0	1	1	0	0/1	GND	HIGH	HIGH	GND
	0	1	0	1	1	1	0/1	GND	HIGH	HIGH	HIGH
	0	1	1	0	0	0	0/1	HIGH	GND	GND	GND
	0	1	1	0	0	1	0/1	HIGH	GND	GND	HIGH
	0	1	1	0	1	0	0/1	HIGH	GND	HIGH	GND
	0	1	1	0	1	1	0/1	HIGH	GND	HIGH	HIGH
	0	1	1	1	0	0	0/1	HIGH	HIGH	GND	GND
	0	1	1	1	0	1	0/1	HIGH	HIGH	GND	HIGH
	0	1	1	1	1	0	0/1	HIGH	HIGH	HIGH	GND
Slave 15	0	1	1	1	1	1	0/1	HIGH	HIGH	HIGH	HIGH

**9.6.2.13.1 AUTONOMOUS MODE**

In autonomous mode, the TPS23881 is capable of operating without any I<sup>2</sup>C communication or host control. As in auto mode, when the device is operating in autonomous mode, the ports will be continuously cycling through discovery, and the ports will automatically power whenever a valid (defection and classification) PD is connected.

Connecting a resistor between the AUTO pin and GND based on the table below will enable autonomous mode and configure all the ports to the same Power Allocation settings. In the event a PD is connected with a higher requested class than the autonomous mode configuration, the port will power demote the PD to the selected autonomous mode configuration power level.

**Table 15. AUTO Pin Programming**

Auto Pin	Autonomous Mode Configuration	Resulting Register Configurations		
		0x12h	0x14h	0x29h
Open/Floating	Disabled	0000, 0000b	0000, 0000b	0000, 0000b
124 kΩ	2-pair 15W	1111, 1111b	1111, 1111b	0000, 0000b
62 kΩ	2-pair 30W	1111, 1111b	1111, 1111b	0011 0011b
35.7 kΩ	4-pair 30W	1111, 1111b	1111, 1111b	1011 1011b
22.6 kΩ	4-pair 45W	1111, 1111b	1111, 1111b	1100, 1100b
15.8 kΩ	4-pair 60W	1111, 1111b	1111, 1111b	1101, 1101b
11 kΩ	4-pair 75W	1111, 1111b	1111, 1111b	1110, 1110b
7.7 kΩ	4-pair 90W	1111, 1111b	1111, 1111b	1111, 1111b

---

**NOTE**

A 10 nF capacitor is required in parallel with R<sub>AUTO</sub> to ensure stability in the Autonomous mode selection.

The I<sup>2</sup>C interface is still fully operational in Autonomous mode, and the all of the port telemetry and configurability is still supported

The Auto pin resistance (R<sub>AUTO</sub>) will not be measured following a device reset (assertion of the RESET pin or RESAL bit in register 0x1A). The device will only measure (R<sub>AUTO</sub>) and pre-configure the internal registers during power up (V<sub>VPWR</sub> and V<sub>VDD</sub> rising above their respective UVLO thresholds).

---

**NOTE**

The device SRAM will need to be programmed in order to support applications that desire to remove a device from Autonomous mode after having initially powered up in Autonomous mode.

A device running from the internal ROM (SRAM unprogrammed) in Autonomous mode will turn off and automatically resume discovery and power on any valid loads following the assertion of the RESET pin, I<sup>2</sup>C register 0x1A RESAL or RESPn bits, or a mode off command. Whereas a device running in Autonomous mode with the SRAM programmed will turn off and remain inactive until the host re-enables the port(s) through the I<sup>2</sup>C bus.

---

**9.6.2.14 OPERATING MODE Register**

COMMAND = 12h with 1 Data Byte, Read/Write

**Figure 58. OPERATING MODE Register Format**

7	6	5	4	3	2	1	0
C4M1	C4M0	C3M1	C3M0	C2M1	C2M0	C1M1	C1M0
R/W-0	R/W-0	R/W-0	R/W-0	R/W-0	R/W-0	R/W-0	R/W-0

LEGEND: R/W = Read/Write; R = Read only; -n = value after reset

**Table 16. OPERATING MODE Register Field Descriptions**

Bit	Field	Type	Reset	Description															
7-0	CnM1–CnM0	R/W	0	<p>Each pair of bits configures the operating mode per channel. The selection is as following:</p> <table border="1"> <thead> <tr> <th>M1</th> <th>M0</th> <th>Operating Mode</th> </tr> </thead> <tbody> <tr> <td>0</td> <td>0</td> <td>OFF</td> </tr> <tr> <td>0</td> <td>1</td> <td>Diagnostic/Manual</td> </tr> <tr> <td>1</td> <td>0</td> <td>Semiauto</td> </tr> <tr> <td>1</td> <td>1</td> <td>Auto</td> </tr> </tbody> </table> <p>For a 4-pair wired port, <b>both</b> channels must be set to the same operating mode. Otherwise, the port will not conduct discovery, and any turn on commands will be ignored.</p>	M1	M0	Operating Mode	0	0	OFF	0	1	Diagnostic/Manual	1	0	Semiauto	1	1	Auto
M1	M0	Operating Mode																	
0	0	OFF																	
0	1	Diagnostic/Manual																	
1	0	Semiauto																	
1	1	Auto																	

**OFF MODE:**

In OFF mode, the Channel is OFF and neither detection nor classification is performed independent of the DETE, CLSE or PWON bits.

The table below depicts what bits will be cleared when a channel is changed to OFF mode from any other operating mode:

**Table 17. Transition to OFF Mode**

Register	Bits to be reset
0x04	CLSCn and DETCn
0x06	DISFn and PCUTn
0x08	STRtn and ILIMn
0x0A/B	PCUTnn
0x0C-0F	Requested Class and Detection
0x10	PGn and PEn
0x14	CLEn and DETEn
0x1C	ACn and CCnn
0x1E-21	2P Policing set to 0xFFh
0x24	PFn
0x2A-2B	4P Policing set to 0xFFh
0x2D	NLMnn, NCTnn, 4PPCTnn, and DCDTnn
0x30-3F	Channel Voltage and Current Measurements
0x40	2xFBn
0x44 - 47	Detection Resistance Measurements
0x4C-4F	Assigned Class and Previous Class
0x51-54	Autoclass Measurement

---

**NOTE**

it may take upwards of 5 ms before all of the registers are cleared following a change to OFF mode.

---

Only the bits associated with the channel/port ("n") being set into OFF mode will be cleared. Those bits associated with channels/ports remaining in operation will not be changed.

In the event either the PGn or PEn bits were changed from a 1 to a zero, the corresponding PGCn and PECn bits will be set in the POWER EVENT register 0x02h.

Also, a change of mode from semiauto to manual/diagnostic mode or OFF mode will cancel any ongoing cooldown time period.



**DIAGNOSTIC/MANUAL MODE:**

In Manual/Diagnostic mode, there is no automatic state change. The channel remains idle until DETE, CLSE (0x14h or 0x18h), or PWON command is provided. Upon the setting of the DETE and/or CLSE bits, the channel will perform a singular detection and/or classification cycle on the corresponding channel.

---

**NOTE**

Setting a PWONn bit in register 0x19 results in the immediate turn on of that channel.

There is no Assigned Class assigned for ports/channels powered out of Manual/Diagnostic mode. Any settings such as the port power policing and 1x/2x foldback selection that are typically configure based on the assigned class result need to manually configured by the user.

---

For 4-Pair wired ports (4PWnn bit in 0x29 = 1):

Setting the DETE or CLSE bits on only one channel will result in detection and/or classification only being done on that channel, and Connection Check will not be performed.

Setting the DETE bits for **both** channels during the same I<sup>2</sup>C operation will result in detection cycles being completed on both channels, and if the detection results are valid, connection check will also be completed.

Setting the CLSE bits for **both** channels during the same I<sup>2</sup>C operation will result in staggered classification measurements being done on both channels

---

**NOTE**

Setting a PWONn bit in register 0x19 results in the immediate turn on of that channel.

---



---

**NOTE**

DC Disconnect for 4-Pair ports power on in Manual/Diagnostic mode will behave as independent channels. Thus, if either channel current falls below  $V_{IMIN}$  for longer than  $t_{MPDO}$ , that channel will be disabled and a disconnect fault will be set (DISFn bits in register 0x06/7).

---

**Table 18. Channel Behavior in Diagnostic/Manual Mode**

CLEn	DETN	PWONn	Channel Operation
0	0	0	Idle
0	1	0	Single Detection measurement (Connection check completed if 4P wired and DETE bits are set for both channels)
1	0	0	Single Classification measurement
1	1	0	Single Detection and Classification measurement done. (Connection check completed if 4P wired and both DETE and CLE bits are set for both channels)
-	-	1	Channel immediate turns on without any detection or classification being performed

**SEMI AUTO MODE:**

In Semi Auto mode, as long as the Channel is unpowered, detection and classifications may be performed continuously depending if the corresponding class and detect enable bits are set (register 0x14h).

**Table 19. Channel Behavior in Semi Auto Mode**

CLEn	DEtn	Channel Operation
0	0	Idle
0	1	Cycling Detection Measurements only
1	0	Idle
1	1	Cycling Detection and Classification Measurements

**NOTE**

If two channels are configured as a 4-pair wired port, a connection check measurement will be performed once a valid detection result is seen on one of the channel

For a 4-Pair Dual Signature PD that has only one channel powered, the unpowered channel will resume detect and class provided the DETE and CLE bits are set for that channel in 0x14h.

**AUTO MODE:**

In **Auto mode**, channels will automatically power on any valid detection and classification signature based on the Port Power Allocation settings in 0x29. The channels will remain idle until DETE and CLSE (0x14 or 0x18) are set, or a PWON command is given.

Prior to setting DETE and CLE or sending a PWON command in AUTO mode, the following registers need to be configured according to the system requirements and configuration:

Register	Bits
0x26	Port Re-mapping
0x29	4-Pair Wired and Port Power Allocation
0x50	Auto AC Enable
0x55	Alternative Inrush and Powered Foldback Enable

**NOTE**

Changes to these registers after the DETE and CLE bits are set in Auto mode may result in undesired or non IEEE complaint operation.

The following registers may be configured or changed after turn on if changes to the default operation are desired as these values are internally set during power on based on the port configuration and resulting assigned PD class:

Register	Bits
0x1E-21	2-Pair Policing
0x2A-2B	4-Pair Policing
0x2D	4P Pcut Enable and DC Disconnect Threshold bits
0x40	2x Foldback Enable

### 9.6.2.15 DISCONNECT ENABLE Register

COMMAND = 13h with 1 Data Byte, Read/Write

**Bit Descriptions:** Defines the disconnect detection mechanism for each channel.

**Figure 59. DISCONNECT ENABLE Register Format**

7	6	5	4	3	2	1	0
–	–	–	–	DCDE4	DCDE3	DCDE2	DCDE1
R/W-0	R/W-0	R/W-0	R/W-0	R/W-1	R/W-1	R/W-1	R/W-1

LEGEND: R/W = Read/Write; R = Read only; -n = value after reset

**Table 20. DISCONNECT ENABLE Register Field Descriptions**

Bit	Field	Type	Reset	Description
7–4	—	R/W	0	
3–0	DCDE4–DCDE1	R/W	1	DC disconnect enable 1 = DC Disconnect Enabled 0 = DC Disconnect Disabled Look at the TIMING CONFIGURATION register for more details on how to define the TDIS time period.

DC disconnect consists in measuring the Channel DC current at SENn, starting a timer ( $T_{DIS}$ ) if this current is below a threshold and turning the Channel off if a time-out occurs. Also, the corresponding disconnect bit (DISFn) in the FAULT EVENT register is set accordingly. The  $T_{DIS}$  counter is reset each time the current rises above the disconnect threshold for at least 3 msec. The counter does not decrement below zero.

#### NOTE

For 4P Single signature devices, if either DCDEx bit is set, both channels will be shut off when the disconnect timer expires.

In the event a singular channel of a 4-pair dual signature PD is turned off due to a disconnect fault or other reason, power may be reapplied to that channel by setting the PWON bit in 0x19h provided the detection and classification are still valid and the Power Allocation settings in 0x29 are sufficient based on the assigned classification of the powered channel.

#### NOTE

The DCDTnn bits in 0x2D set the disconnect threshold.

The DCDTnn bits are automatically configured during turn on based on the 4PWnn bits in 0x29 and the Assigned classification results (0x4C-4F) based on IEEE compliance requirements.

### 9.6.2.16 DETECT/CLASS ENABLE Register

COMMAND = 14h with 1 Data Byte, Read/Write

During  $t_{OVL D}$ ,  $t_{LIM}$  or  $t_{START}$  cool down cycle, any Detect/Class Enable command for that channel will be delayed until end of cool-down period. Note that at the end of cool down cycle, one or more detection/class cycles are automatically restarted as described previously, if the class and/or detect enable bits are set.

**Figure 60. DETECT/CLASS ENABLE Register Format**

7	6	5	4	3	2	1	0
CLE4	CLE3	CLE2	CLE1	DETE4	DETE3	DETE2	DETE1
R/W-0	R/W-0	R/W-0	R/W-0	R/W-0	R/W-0	R/W-0	R/W-0

LEGEND: R/W = Read/Write; R = Read only; -n = value after reset

**Table 21. DETECT/CLASS ENABLE Register Field Descriptions**

Bit	Field	Type	Reset	Description
7–4	CLE4-CLE1	R/W	0	Classification enable bits.
3–0	DETE4-DETE1	R/W	0	Detection enable bits.

#### Bit Descriptions:

Detection and classification enable for each channel.

When in Manual mode, setting a bit means that only one cycle (detection or classification) is performed for the corresponding channel. The bit is automatically cleared by the time the cycle has been completed.

Note that similar result can be obtained by writing to the Detect/Class Restart register 0x18.

It is also cleared if a turn off (Power Enable register) command is issued.

When in semiauto mode, as long as the port is kept off, detection and classification are performed continuously, as long as the class and detect enable bits are kept set, but the class will be done only if the detection was valid. A Detect/Class Restart PB command can also be used to set the CLEn and DETEn bits, if in semiauto mode.

---

#### NOTE

For 4-pair wired Ports in Semi-Auto or Auto mode, **both** DETEn and CLEn bits need to be set on **both** channels in order for Detection or Classification to be enabled

---

#### NOTE

In Manual/Diagnostic mode, it is recommended that a Port Reset command (see register 0x1A [RESET Register](#)) be completed prior to enabling discovery (DETEn or CLEn).

---

**9.6.2.17 Power Priority / 2Pair PCUT Disable Register Name**

COMMAND = 15h with 1 Data Byte, R/W

**Figure 61. Power Priority / 2P-PCUT Disable Register Format**

7	6	5	4	3	2	1	0
OSS4	OSS3	OSS2	OSS1	DCUT4	DCUT3	DCUT2	DCUT1
R/W-0	R/W-0	R/W-0	R/W-0	R/W-0	R/W-0	R/W-0	R/W-0

LEGEND: R/W = Read/Write; R = Read only; -n = value after reset

**Table 22. Power Priority / 2P-PCUT Disable Register Field Descriptions**

Bit	Field	Type	Reset	Description
7–4	OSS4-OSS1	R/W	0	Power priority bits: When the MBitPrty bit in 0x17 =0: 1 = When the OSS signal is asserted, the corresponding channel is powered off. 0 = OSS signal has no impact on the channel. For 4-pair wired Ports, these bits control the <b>individual</b> Channel response. In order for both channels of a 4-pair wired port to be disabled, both channels need to be set to 1.
3–0	DCUT4-DCUT1	R/W	0	2-Pair PCUT disable for each channel. Used to prevent removal of the associated channel's power due to a 2-Pair PCUT fault, regardless of the programming status of the Timing Configuration register. Note that there is still monitoring of ILIM faults. 1: Channel's PCUT is disabled. This means that an PCUT fault alone will not turn off this channel. 0: Channel's PCUT is enabled. This enables channel turn off if there is PCUT fault.

---

**NOTE**

If the MbitPrty bit = 1 (0x17h): The OSSn bits must be cleared to ensure proper operation. Refer to registers 0x27/28h for more information on the Multi-bit priority shutdown feature.

---

**NOTE**

If DCUT = 1 for a channel, the channel will not be automatically turned off during a PCUT fault condition. However, the PCUT fault flag will still be operational, with a fault timeout equal to  $t_{OVLD}$ .

Any change in the state of DCUTn bits will result in the resetting of the  $T_{OVLD}$  timer for that channel.

---

**NOTE**

For 4-pair wired Ports:

These bits control the **individual** Channel response to a 2-Pair PCUT fault.

If the NCTnn bit in 0x2D = 1 and the 2-Pair PCut is enabled, **both** channel will be turned off if the overload condition exceeds the  $t_{OVLD}$  timeout.

The response to a summed 4-pair PCUT fault is configured in register 0x2Dh.

---

The OSSn bits are used to determine which channels are shut down in response to an external assertion of the OSS fast shutdown signal.

The turn off procedure due to OSS is similar to a channel reset or change to OFF mode, with the exception that OSS does not cancel any ongoing fault cool down timers. the table below includes the bits that will be cleared when a channel is disabled due to OSS:

**Table 23. Channel Turn Off with OSS**

Register	Bits to be reset
0x04	CLSCn and DETCn
0x06	DISFn and PCUTn
0x08	STRn and ILIMn
0x0A/B	PCUTnn
0x0C-0F	Requested Class and Detection
0x10	PGn and PEn
0x14	CLEn and DETEn
0x1C	ACn and CCnn
0x1E-21	2P Policing set to 0xFFh
0x24	PFn
0x2A-2B	4P Policing set to 0xFFh
0x2D	NLMnn, NCTnn, 4PPCTnn, and DCDTnn
0x30-3F	Channel Voltage and Current Measurements
0x40	2xFBn
0x44 - 47	Detection Resistance Measurements
0x4C-4F	Assigned Class and Previous Class
0x51-54	Autoclass Measurement

---

**NOTE**

it may take upwards of 5 ms before all of the registers are cleared following an OSS event.

---

Only the bits associated with the channel/port ("n") with OSS enabled will be cleared. Those bits associated with channels/ports remaining in operation will not be changed.

In the event a singular channel of a 4-pair dual signature PD is turned off due to OSS or PCUT fault, power may be reapplied to that channel by setting the PWON bit in 0x19h provided the detection and classification are still valid and the Power Allocation settings in 0x29 are sufficient based on the assigned classification of the powered channel.

9.6.2.18 TIMING CONFIGURATION Register

COMMAND = 16h with 1 Data Byte, Read/Write

Bit Descriptions: These bits define the timing configuration for all four channels.

Figure 62. TIMING CONFIGURATION Register Format

7		6		5		4		3		2		1		0	
TLIM				TSTART				TOVLD				TMPDO			
R/W-0		R/W-0		R/W-0		R/W-0		R/W-0		R/W-0		R/W-0		R/W-0	

LEGEND: R/W = Read/Write; R = Read only; -n = value after reset

Table 24. TIMING CONFIGURATION Register Field Descriptions

Bit	Field	Type	Reset	Description										
7-6	TLIM	R/W	0	<p>ILIM fault timing, which is the output current limit time duration before channel turn off.</p> <p>When a 2xFBn bit in register 0x40 = 0, the <math>t_{LIM}</math> used for the associated channel is always the nominal value (about 60 ms).</p> <p>This timer is active and increments to the settings defined below after expiration of the TSTART time window and when the channel is limiting its output current to <math>I_{LIM}</math>. If the ILIM counter is allowed to reach the programmed time-out duration specified below, the channel will be powered off. The 1-second cool down timer is then started, and the channel can not be turned-on until the counter has reached completion.</p> <p>In other circumstances (ILIM time-out has not been reached), while the channel current is below <math>I_{LIM}</math>, the same counter decrements at a rate 1/16th of the increment rate. The counter does not decrement below zero. The ILIM counter is also cleared in the event of a turn off due to a Power Enable or Reset command, a DC disconnect event or the OSS input.</p> <p>Note that in the event the TLIM setting is changed while this timer is already active for a channel, this timer is automatically reset then restarted with the new programmed time-out duration.</p> <p>Note that at the end of cool down cycle, when in semiauto mode, a detection cycle is automatically restarted if the detect enable bit is set. Also note that the cool down time count is immediately canceled with a reset command, or if the OFF or Manual mode is selected.</p> <p>If 2xFBn bit is asserted in register 0x40, then <math>t_{LIM}</math> for associated channel is programmable with the following selection:</p> <table border="1"> <thead> <tr> <th>TLIM</th> <th>Minimum <math>t_{LIM}</math> (ms)</th> </tr> </thead> <tbody> <tr> <td>0 0</td> <td>58</td> </tr> <tr> <td>0 1</td> <td>15</td> </tr> <tr> <td>1 0</td> <td>10</td> </tr> <tr> <td>1 1</td> <td>6</td> </tr> </tbody> </table>	TLIM	Minimum $t_{LIM}$ (ms)	0 0	58	0 1	15	1 0	10	1 1	6
TLIM	Minimum $t_{LIM}$ (ms)													
0 0	58													
0 1	15													
1 0	10													
1 1	6													
5-4	TSTART (or TINRUSH)	R/W	0	<p>START fault timing, which is the maximum allowed overcurrent time during inrush. If at the end of TSTART period the current is still limited to <math>I_{Inrush}</math>, the channel is powered off.</p> <p>This is followed by a 1-second cool down period, during which the channel can not be turned-on</p> <p>Note that at the end of cool down cycle, when in semiauto mode, a detection cycle is automatically restarted if the class and detect enable bits are set.</p> <p>Note that in the event the TSTART setting is changed while this timer is already active for a channel, this new setting is ignored and will be applied only next time the channel is turned ON.</p> <p>The selection is as following:</p> <table border="1"> <thead> <tr> <th>TSTART</th> <th>Nominal <math>t_{START}</math> (ms)</th> </tr> </thead> <tbody> <tr> <td>0 0</td> <td>60</td> </tr> <tr> <td>0 1</td> <td>30</td> </tr> <tr> <td>1 0</td> <td>120</td> </tr> <tr> <td>1 1</td> <td>Reserved</td> </tr> </tbody> </table>	TSTART	Nominal $t_{START}$ (ms)	0 0	60	0 1	30	1 0	120	1 1	Reserved
TSTART	Nominal $t_{START}$ (ms)													
0 0	60													
0 1	30													
1 0	120													
1 1	Reserved													

**Table 24. TIMING CONFIGURATION Register Field Descriptions (continued)**

Bit	Field	Type	Reset	Description															
3–2	TOVLD	R/W	0	<p>PCUT fault timing, which is the overcurrent time duration before turn off. This timer is active and increments to the settings defined below after expiration of the TSTART time window and when the current meets or exceeds <math>P_{CUT}</math>, or when it is limited by the current foldback. If the PCUT counter is allowed to reach the programmed time-out duration specified below, the channel will be powered off. The 1-second cool down timer is then started, and the channel can not be turned-on until the counter has reached completion.</p> <p>In other circumstances (PCUT time-out has not been reached), while the current is below <math>P_{CUT}</math>, the same counter decrements at a rate 1/16th of the increment rate. The counter does not decrement below zero. The PCUT counter is also cleared in the event of a turn off due to a Power Enable or Reset command, a DC disconnect event or the OSS input</p> <p>Note that in the event the TOVLD setting is changed while this timer is already active for a channel, this timer is automatically reset then restarted with the new programmed time-out duration.</p> <p>Note that at the end of cool down cycle, when in semiauto mode, a detection cycle is automatically restarted if the detect enable bit is set. Also note that the cool down time count is immediately canceled with a reset command, or if the OFF or Manual mode is selected.</p> <p>Note that if a DCUTn bit is high in the Power Priority/PCUT Disable register, the PCUT fault timing for the associated channel is still active. However, even though the channel will not be turned off when the tOVLD time expires, the PCUT fault bits will still be set.</p> <p>The selection is as following:</p> <table border="1" style="margin-left: 40px;"> <thead> <tr> <th colspan="2">TOVLD</th> <th>Nominal <math>t_{OVLD}</math> (ms)</th> </tr> </thead> <tbody> <tr> <td>0</td> <td>0</td> <td>60</td> </tr> <tr> <td>0</td> <td>1</td> <td>30</td> </tr> <tr> <td>1</td> <td>0</td> <td>120</td> </tr> <tr> <td>1</td> <td>1</td> <td>240</td> </tr> </tbody> </table>	TOVLD		Nominal $t_{OVLD}$ (ms)	0	0	60	0	1	30	1	0	120	1	1	240
TOVLD		Nominal $t_{OVLD}$ (ms)																	
0	0	60																	
0	1	30																	
1	0	120																	
1	1	240																	
1–0	TMPDO	R/W	0	<p>Disconnect delay, which is the time to turn off a channel once there is a disconnect condition, and if the dc disconnect detect method has been enabled.</p> <p>The TDIS counter is reset each time the current goes continuously higher than the disconnect threshold for nominally 15 ms.</p> <p>The counter does not decrement below zero.</p> <p>The selection is as following:</p> <table border="1" style="margin-left: 40px;"> <thead> <tr> <th colspan="2">TMPDO</th> <th>Nominal <math>t_{MPDO}</math> (ms)</th> </tr> </thead> <tbody> <tr> <td>0</td> <td>0</td> <td>360</td> </tr> <tr> <td>0</td> <td>1</td> <td>90</td> </tr> <tr> <td>1</td> <td>0</td> <td>180</td> </tr> <tr> <td>1</td> <td>1</td> <td>720</td> </tr> </tbody> </table>	TMPDO		Nominal $t_{MPDO}$ (ms)	0	0	360	0	1	90	1	0	180	1	1	720
TMPDO		Nominal $t_{MPDO}$ (ms)																	
0	0	360																	
0	1	90																	
1	0	180																	
1	1	720																	

**NOTE**

The PGN and PEn bits (Power Status register) are cleared when there is a TLIM, TOVLD, TMPDO, or TSTART fault condition.

**NOTE**

The settings for  $t_{LIM}$  set the minimum timeout based on the IEEE compliance requirements.

**NOTE**

The  $t_{OVLD}$  time for 4-pair Pcut faults will be equal to the  $t_{OVLD}$  setting + approximately 6 ms



### 9.6.2.19 GENERAL MASK Register

COMMAND = 17h with 1 Data Byte, Read/Write

**Figure 63. GENERAL MASK Register Format**

7	6	5	4	3	2	1	0
INTEN	–	nbitACC	MbitPrty	CLCHE	DECHE	–	–
R/W-1	R/W-0	R/W-0	R/W-0	R/W-0	R/W-0	R/W-0	R/W-0

LEGEND: R/W = Read/Write; R = Read only; -n = value after reset

**Table 25. GENERAL MASK Register Field Descriptions**

Bit	Field	Type	Reset	Description
7	INTEN	R/W	1	<p><math>\overline{\text{INT}}</math> pin mask bit. Writing a 0 will mask any bit of Interrupt register from activating the <math>\overline{\text{INT}}</math> output, whatever the state of the Interrupt Mask register. Note that activating INTEN has no impact on the event registers.</p> <p>1 = Any unmasked bit of Interrupt register can activate the <math>\overline{\text{INT}}</math> output</p> <p>0 = <math>\overline{\text{INT}}</math> output cannot be activated</p>
6	–	R/W	0	
5	nbitACC	R/W	0	<p>I<sup>2</sup>C Register Access Configuration bit.</p> <p>1 = Configuration B. This means 16-bit access with a single device address (A0 = 0).</p> <p>0 = Configuration A. This means 8-bit access, while the 8-channel device is treated as 2 separate 4-channel devices with 2 consecutive slave addresses.</p> <p>See register 0x11 for more information on the I2C address programming</p>
4	MbitPrty	R/W	0	<p>Multi Bit Priority bit. Used to select between 1-bit shutdown priority and 3-bit shutdown priority.</p> <p>1 = 3-bit shutdown priority. Register 0x27 and 0x28 need to be followed for priority and OSS action.</p> <p>0 = 1-bit shutdown priority. Register 0x15 needs to be followed for priority and OSS action</p>
3	CLCHE	R/W	0	<p>Class change Enable bit. When set, the CLSCn bits in Detection Event register only indicates when the result of the most current classification operation differs from the result of the previous one.</p> <p>1 = CLSCn bit is set only when a change of class occurred for the associated channel.</p> <p>0 = CLSCn bit is set each time a classification cycle occurred for the associated channel.</p>
2	DECHE	R/W	0	<p>Detect Change Enable bit. When set, the DETCn bits in Detection Event register only indicates when the result of the most current detection operation differs from the result of the previous one.</p> <p>1 = DETCn bit is set only when a change in detection occurred for the associated channel.</p> <p>0 = DETCn bit is set each time a detection cycle occurred for the associated channel.</p>
1	–	R/W	0	
0	–	R/W	0	

**NOTE**

If the MbitPrty bit needs to be changed from 0 to 1, make sure the OSS input pin is in the idle (low) state for a minimum of 200  $\mu\text{sec}$  prior to setting the MbitPrty bit, to avoid any misbehavior related to loss of synchronization with the OSS bit stream.

**NOTE**

Only the nbitACC bit for channels 1-4 needs to be set to enable 16-bit I<sup>2</sup>C operation.

**Table 26. nbitACC = 1: Register Operations in 8-Bit (Config A) and 16-bit (Config B) I<sup>2</sup>C Mode**

Cmd Code	Register or Command Name	Bits Description	Configuration A (8-bit)	Configuration B (16-bit)
00h	INTERRUPT	INT bits P1-4, P5-8	Separate mask and interrupt result per group of 4 channels. The Supply event bit is repeated twice.	
01h	INTERRUPT MASK	MSK bits P1-4, P5-8		
02h	POWER EVENT	PGC_PEC P4-1, P8-5	Separate event byte per group of 4 channels.	
03h				
04h	DETECTION EVENT	CLS_DET P4-1, P8-5		
05h				
06h	FAULT EVENT	DIS_PCUT P4-1, P8-5		
07h				
08h	START/LIM EVENT	ILIM_STR P4-1, P8-5		
09h				
0Ah	SUPPLY/FAULT EVENT	TSD, VDUV, VDUW, VPUV, RAMFLT	Both 8-bit registers (channel 1 to 4 and channel 5 to 8) will show the <b>same</b> results for TSD, VDUV, VPUV and RAMFLT. The PCUTxx and OSSEx bits will. have separate status per group of 4 channels. Clearing at least one VPUV/VDUV also clears the other one.	
0Bh		PCUT34, PCUT12, PCUT78, PCUT56, OSSE4-1, OSSE8-5		
0Ch	CHANNEL 1 DISCOVERY	CLS&DET1_CLS&DET5	Separate Status byte per channel	
0Dh	CHANNEL 2 DISCOVERY	CLS&DET2_CLS&DET6		
0Eh	CHANNEL 3 DISCOVERY	CLS&DET3_CLS&DET7		
0Fh	CHANNEL 4 DISCOVERY	CLS&DET4_CLS&DET8		
10h	POWER STATUS	PG_PE P4-1, P8-5	Separate status byte per group of 4 channels	
11h	PIN STATUS	AUTO,A4-A1,A0	Both 8-bit registers (channel 1 to 4 and channel 5 to 8) will show the <b>same</b> result, except that A0 = 0 (channel 1 to 4) or 1 (channel 5 to 8).	Both 8-bit registers (channel 1 to 4 and channel 5 to 8) will show the <b>same</b> result, including A0 = 0.
12h	OPERATING MODE	MODE P4-1, P8-5	Separate Mode byte per group of 4 channels.	
13h	DISCONNECT ENABLE	DCDE P4-1, P8-5	Separate DC disconnect enable byte per group of 4 channels.	
14h	DETECT/CLASS ENABLE	CLE_DETE P4-1, P8-5	Separate Detect/Class Enable byte per group of 4 channels.	
15h	PWRPR/2P-PCUT DISABLE	OSS_DCUT P4-1, P8-5	Separate OSS/DCUT byte per group of 4 channels.	
16h	TIMING CONFIG	TLIM_TSTRT_TOVLD_TMPDO P4-1, P8-5	Separate Timing byte per group of 4 channels.	
17h	GENERAL MASK	P4-1, P8-5 including n-bit access	Separate byte per group of 4 channels. n-bit access: Setting this in at least one of the virtual quad register space is enough to enter Config B mode. To go back to config A, clear both. MbitPrty: Setting this in at least one of the virtual quad register space is enough to enter 3-bit shutdown priority. To go back to 1-bit shutdown, clear both MbitPrty bits.	
18h	DETECT/CLASS Restart	RCL_RDET P4-1, P8-5	Separate DET/CL RST byte per group of 4 channels	
19h	POWER ENABLE	POF_PWON P4-1, P8-5	Separate POF/PWON byte per group of 4 channels	
1Ah	RESET	P4-1, P8-5	Separate byte per group of 4 channels, Clear Int pin and Clear All int.	Separate byte per group of 4 channels.
1Bh	ID		Both 8-bit registers (channel 1 to 4 and channel 5 to 8) will show the <b>same</b> result unless modified through I <sup>2</sup> C.	
1Ch	Autoclass and Connection Check	AC4-1, CC34 - 12, AC8-5, CC78-56	Separate byte per group of 4 channels.	

**Table 26. nbitACC = 1: Register Operations in 8-Bit (Config A) and 16-bit (Config B) I<sup>2</sup>C Mode (continued)**

Cmd Code	Register or Command Name	Bits Description	Configuration A (8-bit)	Configuration B (16-bit)
1Eh	2P POLICE 1/5 CONFIG	POL1, POL5	Separate Policing byte per channel.	
1Fh	2P POLICE 2/6 CONFIG	POL2, POL6		
20h	2P POLICE 3/7 CONFIG	POL3, POL7		
21h	2P POLICE 4/8 CONFIG	POL4, POL8		
22h	CAP MEASUREMENT	CDET4-1, CDET8-5	Separate capacitance measurement enable bytes per group of 4 channels.	
24h	Power-on FAULT	PF P4-1, P8-5	Separate Power-on FAULT byte per group of 4 channels	
25h				
26h	PORT REMAPPING	Logical P4-1, P8-5	Separate Remapping byte per group of 4 channels. Reinitialized only if POR or RESET pin. Kept unchanged if 0x1A IC reset or CPU watchdog reset.	
27h	Multi-Bit Priority 21 / 65	MBP2-1, MBP6-5	Separate MBP byte per group of 2 channels	
28h	Multi-Bit Priority 43 / 87	MBP4-3, MBP8-7	Separate MBP byte per group of 2 channels	
29h	PORT POWER ALLOCATION	4PW34-12, MC34-12, 4PW78-56, MC78-56	Separate 4Pnn, MCnn byte per group of 4 channels	
2Ah	4P POLICE 12 / 56 CONFIG	POL12, POL56	Separate 4P Policing byte per channel	
2Bh	4P POLICE 34 / 78CONFIG	POL34, POL78	Separate 4P Policing byte per channel	
2Ch	TEMPERATURE	TEMP P1-4, P5-8	Both 8-bit registers (channel 1 to 4 and channel 5 to 8) must show the <b>same</b> result.	
2Dh	4P FAULT CONFIG	NLM4-1, NCT4-1, 4PPCT4-1,DCDT4-1, NLM8-5, NCT8-5, 4PPCT8-5,DCDT8-5	Separate fault handling byte per group of 4 channels	
2Eh	INPUT VOLTAGE	VPWR P1-4, P5-8	Both 8-bit registers (channel 1 to 4 and channel 5 to 8) must show the <b>same</b> result.	
2Fh				
30h	CHANNEL 1 CURRENT	I1, I5	Separate 2-byte per group of 4 channels	Separate 2-byte per group of 4 channels. 2-byte Read at 0x30 gives I1 4-byte Read at 0x30 gives I1, I5.
31h			N/A	2-byte Read at 0x31 gives I5.
32h	CHANNEL 1 VOLTAGE	V1, V5	Separate 2-byte per group of 4 channels	2-byte Read at 0x32 gives V1 4-byte Read at 0x32 gives V1, V5.
33h			N/A	2-byte Read at 0x33 gives V5.
34h	CHANNEL 2 CURRENT	I2, I6	Separate 2-byte per group of 4 channels	2-byte Read at 0x34 gives I2 4-byte Read at 0x34 gives I2, I6.
35h			N/A	2-byte Read at 0x35 gives I6.
36h	CHANNEL 2 VOLTAGE	V2, V6	Separate 2-byte per group of 4 channels	2-byte Read at 0x36 gives V2 4-byte Read at 0x36 gives V2, V6.
37h			N/A	2-byte Read at 0x37 gives V6.
38h	CHANNEL 3 CURRENT	I3, I7	Separate 2-byte per group of 4 channels	2-byte Read at 0x38 gives I3 4-byte Read at 0x38 gives I3, I7.
39h			N/A	2-byte Read at 0x39 gives I7.
3Ah	CHANNEL 3 VOLTAGE	V3, V7	Separate 2-byte per group of 4 channels	2-byte Read at 0x3A gives V3 4-byte Read at 0x3A gives V3, V7.
3Bh			N/A	2-byte Read at 0x3B gives V7.

**Table 26. nbitACC = 1: Register Operations in 8-Bit (Config A) and 16-bit (Config B) I<sup>2</sup>C Mode (continued)**

Cmd Code	Register or Command Name	Bits Description	Configuration A (8-bit)	Configuration B (16-bit)
3Ch	CHANNEL 4 CURRENT	I4, I8	Separate 2-byte per group of 4 channels	2-byte Read at 0x3C gives I4 4-byte Read at 0x3C gives I4, I8.
3Dh			N/A	2-byte Read at 0x3D gives I8.
3Eh	CHANNEL 4 VOLTAGE	V4, V8	Separate 2-byte per group of 4 channels	2-byte Read at 0x3E gives V4 4-byte Read at 0x3E gives V4, V8.
3Fh			N/A	2-byte Read at 0x3F gives V8.
40h	OPERATIONAL FOLDBACK	2xFB4-1, 2xFB8-5	Separate 2xFBn config byte per group of 4 channels.	
41h	FIRMWARE REVISION	FRV P1-4, P5-8	Both 8-bit registers (channel 1 to 4 and channel 5 to 8) must show the <b>same</b> result.	
42h	I2C WATCHDOG	P1-4, P5-8	IWD3-0: if at least one of the two 4-port settings is different than 1011b, the watchdog is enabled for all 8 channels. WDS: Both 8-bit registers (channel 1 to 4 and channel 5 to 8) must show the <b>same</b> WDS result. Each WDS bit needs to be cleared individually through I <sup>2</sup> C.	
43h	DEVICE ID	DID_SR P1-4, P5-8	Both 8-bit registers (channel 1 to 4 and channel 5 to 8) will show the <b>same</b> result .	
44h	CHANNEL 1 RESISTANCE	RDET1, RDET5	Separate byte per channel. Detection resistance always updated, detection good or bad.	
45h	CHANNEL 2 RESISTANCE	RDET2, RDET6		
46h	CHANNEL 3 RESISTANCE	RDET3, RDET7		
47h	CHANNEL 4 RESISTANCE	RDET4, RDET8		
4Ch	CHANNEL 1 ASSIGNED CLASS	ACLS&PCLS1_ACLS&PCLS5	Separate Status byte per channel	
4Dh	CHANNEL 2 ASSIGNED CLASS	ACLS&PCLS2_ACLS&PCLS6		
4Eh	CHANNEL 3 ASSIGNED CLASS	ACLS&PCLS3_ACLS&PCLS7		
4Fh	CHANNEL 4 ASSIGNED CLASS	ACLS&PCLS4_ACLS&PCLS8		
50h	AUTOCLASS CONTROL	MAC4-1, AAC4-1, MAC8-5, AAC8-5	Separate Auto Class control bytes per 4 channels	
51h	AUTOCLASS POWER 1/5	PAC1, PAC5	Separate Auto Class Power Measurement byte per channel	
52h	AUTOCLASS POWER 2/6	PAC2, PAC6		
53h	AUTOCLASS POWER 3/7	PAC3, PAC7		
54h	AUTOCLASS POWER 4/8	PAC4, PAC8		
55h	ALTERNATIVE FOLDBACK	ALTFB4-1, ALTIR4-1, ALTFN8-5, ALTIR8-5	Separate Alternative Foldback byte per group of 4 channels	
60h	SRAM CONTROL	SRAM CNTRL BITS	These bits must be configured for the lower virtual quad (A0=0, CH 1-4)). These bits have no functionality for the upper virtual quad (A0=1, Ch 5-8) device	
61h	SRAM DATA		Streaming data input is independent of I <sup>2</sup> C configuration	
62h	START ADDRESS (LSB)		These bits must be configured for the lower virtual quad (A0=0, CH 1-4)). These bits have no functionality for the upper virtual quad (A0=1, Ch 5-8) device	
63h	START ADDRESS (MSB)		These bits must be configured for the lower virtual quad (A0=0, CH 1-4)). These bits have no functionality for the upper virtual quad (A0=1, Ch 5-8) device	

### 9.6.2.20 DETECT/CLASS RESTART Register

COMMAND = 18h with 1 Data Byte, Write Only

Push button register.

Each bit corresponds to a particular cycle (detect or class restart) per channel. Each cycle can be individually triggered by writing a 1 at that bit location, while writing a 0 does not change anything for that event.

In Diagnostic/Manual mode, a single cycle (detect or class restart) will be triggered when these bits are set while in Semi Auto mode, it sets the corresponding bit in the Detect/Class Enable register 0x14.

A Read operation will return 00h.

During  $t_{OVL D}$ ,  $t_{LIM}$  or  $t_{START}$  cool down cycle, any Detect/Class Restart command for that channel will be accepted but the corresponding action will be delayed until end of cool-down period.

**Figure 64. DETECT/CLASS RESTART Register Format**

7	6	5	4	3	2	1	0
RCL4	RCL3	RCL2	RCL1	RDET4	RDET3	RDET2	RDET1
W-0	W-0	W-0	W-0	W-0	W-0	W-0	W-0

LEGEND: R/W = Read/Write; R = Read only; W = Write only; -n = value after reset

**Table 27. DETECT/CLASS RESTART Register Field Descriptions**

Bit	Field	Type	Reset	Description
7–4	RCL4–RCL1	W	0	Restart classification bit
3–0	RDET4–RDET1	W	0	Restart detection bits

These bits may be used in place of completing a "Read-Modify-Write" sequence in register 0x14 to enable detection and classification on a per channel basis.

For 4-pair wired ports in Semi Auto or Auto mode, both bits need to be set in order for Detection or Classification to be enabled

### 9.6.2.21 POWER ENABLE Register

COMMAND = 19h with 1 Data Byte, Write Only

Push button register.

Used to initiate a channel(s) turn on or turn off in any mode except OFF mode.

**Figure 65. POWER ENABLE Register Format**

7	6	5	4	3	2	1	0
POFF4	POFF3	POFF2	POFF1	PWON4	PWON3	PWON2	PWON1
W-0	W-0	W-0	W-0	W-0	W-0	W-0	W-0

LEGEND: R/W = Read/Write; R = Read only; W = Write only; -n = value after reset

**Table 28. POWER ENABLE Register Field Descriptions**

Bit	Field	Type	Reset	Description
7–4	POFF4–POFF1	W	0	Channel power off bits
3–0	PWON4–PWON1	W	0	Channel power on bits

---

**NOTE**

Writing a “1” at POFFn and PWONn on same Channel during the same write operation turns the Channel off.

---



---

**NOTE**

The  $t_{OVLD}$ ,  $t_{LIM}$ ,  $t_{START}$  and disconnect events have priority over the PWON command. During  $t_{OVLD}$ ,  $t_{LIM}$  or  $t_{START}$ , cool down cycle, any channel turn on using Power Enable command will be ignored and the Channel will be kept off.

---



---

**NOTE**

For 4-Pair wired ports:

These bits control the individual Channel response of each Channel. Thus it is recommended that for 4-pair wire ports, the bits for both channels be set simultaneously.

In Semi Auto mode with DETE = CLE = 1 on both channels, it is permissible to set only one PWON bit to attempt to turn on only that singular channel.

For 4P Single Signature devices that classify as class 5-8, a singular PWON command will fail and a STRT fault set with the “insufficient power” code written to 0x24.

If the PD presents itself as class 4 or below, then only that pair set will be powered.

Setting the alternate PWON bit for the secondary channel of a single signature device after the primary is already powered will result in the immediate turn on of the channel without completing DET or CLS.

For a 4-Pair Dual Signature device that has only one channel powered, setting the PWON bit for the unpowered channel will result in a turn on attempt on that channel based on the assigned classification of the other channel and the Power Allocation settings in 0x29h at the time of the new PWON command.

---

#### PWONn in Diagnostic/Manual Mode:

If the PSE controller is configured in Diagnostic mode, writing a “1” at that PWONn bit location will immediately turn on the associated Channel.

**PWONn in Semi Auto Mode:**

While in Semi Auto mode, writing a “1” at a PWONn bit will attempt to turn on the associated Channel. If the detection or class results are invalid, the Channel is not turned on, and there will be no additional attempts to turn on the Channel until this push button is reasserted and the channel will resume its configured semi auto mode operation.

---

**NOTE**

In Semi Auto mode, the Power Allocation (0x29h) value needs to be set prior to issuing a PWON command. Any changes to the Power Allocation value after a PWON command is given may be ignored.

---

**Table 29. Channel Response to PWONn Command in Semi Auto Mode**

CLEn	DETEn	Channel Operation	Result of PWONn Command
0	0	Idle	Singular Turn On attempted with Full DET and CLS cycle
0	1	Cycling Detection Measurements only	Singular Turn On attempted with Full DET and CLS cycle
1	0	Idle	Singular Turn On attempted with Full DET and CLS cycle
1	1	Cycling Detection and Classification Measurements	Singular Turn On attempted after next (or current) DET and CLS cycle

In semi auto mode with DETE and CLE set, as long as the PWONx command is received prior to the start of classification, the Channel will be powered immediately after classification is complete provided the classification result is valid and the power allocations settings (see register 0x29h) are sufficient to enable power on.

**PWONn in Auto Mode:**

In Auto mode with DETE or CLE set to 0, a PWONx command will initiate a singular detection and classification cycle and the port/channel will be powered immediately after classification is complete provided the classification result is valid and the power allocations settings (see register 0x29h) are sufficient to enable power on.

In Auto mode with DETE and CLE = 1, there is no need for a PWON command. The port/channel will automatically attempt to turn on after each detection and classification cycle.

---

**NOTE**

In Auto mode, the Power Allocation (0x29h) value needs to be set prior to issuing a PWON command. Any changes to the Power Allocation value after a PWON command is given may be ignored.

A singular PWONn command will be ignored for a 4-Pair wired port in Auto mode.

---

**Table 30. Channel Response to PWONn Command in Auto Mode**

CLEn	DETEn	Channel Operation	Result of PWONn Command
0	0	Idle	Singular Turn On attempted with Full DET and CLS cycle
0	1	Cycling Detection Measurements only	Singular Turn On attempted with Full DET and CLS cycle
1	0	Idle	Singular Turn On attempted with Full DET and CLS cycle
1	1	Cycling Detection and Classification Measurements	NA - Channel will power automatically after a valid detection and classification

**PWOFn in any Mode:**

The channel is immediately disabled and the following registers are cleared:

**Table 31. Channel Turn Off with PWOFn Command**

Register	Bits to be Reset
0x04	CLSCn and DETCn
0x06	DISFn and PCUTn
0x08	STRn and ILIMn
0x0A/B	PCUTnn
0x0C-0F	Requested Class and Detection
0x10	PGn and PEn
0x14	CLEn and DETEn
0x1C	ACn and CCnn
0x1E-21	2P Policing set to 0xFFh
0x24	PFn
0x2A-2B	4P Policing set to 0xFFh
0x2D	NLMnn, NCTnn, 4PPCTnn, and DCDTnn
0x30-3F	Channel Voltage and Current Measurements
0x40	2xFBn
0x44 - 47	Detection Resistance Measurements
0x4C-4F	Assigned Class and Previous Class
0x51-54	Autoclass Measurement

---

**NOTE**

It may take upwards of 5ms after PWOFn command for all register values to be updated.

---

Only the bits associated with the channel/port ("n") with PWOFn set will be cleared. Those bits associated with channels/ports remaining in operation will not be changed.

These bits control the response of each channel **individually**. Thus, it is recommended that for 4-pair wire ports, the bits for both channels be set simultaneously.

---

**NOTE**

If only one channel of a 4-pair single signature load with a Class 5 or higher assigned class is given a PWOFn command, **both** channels will be disabled.

---

In the event a singular channel of a 4-pair dual signature PD is turned off due to a PWOFn command, the power may be reapplied to that channel by setting the PWON bit in 0x19h provided the detection and classification are still valid and the Power Allocation settings in 0x29 are sufficient based on the assigned classification of the powered channel.



### 9.6.2.22 RESET Register

COMMAND = 1Ah with 1 Data Byte, Write Only

Push button register.

Writing a 1 at a bit location triggers an event while a 0 has no impact. Self-clearing bits.

**Figure 66. RESET Register Format**

7	6	5	4	3	2	1	0
CLRAIN	CLINP	–	RESAL	RESP4	RESP3	RESP2	RESP1
W-0	W-0	W-0	W-0	W-0	W-0	W-0	W-0

LEGEND: R/W = Read/Write; R = Read only; W = Write only; -n = value after reset

**Table 32. RESET Register Field Descriptions**

Bit	Field	Type	Reset	Description
7	CLRAIN	W	0	Clear all interrupts bit. Writing a 1 to CLRAIN clears all event registers and all bits in the Interrupt register. It also releases the $\overline{\text{INT}}$ pin
6	CLINP	W	0	When set, it releases the $\overline{\text{INT}}$ pin without any impact on the Event registers nor on the Interrupt register.
5	–	W	0	
4	RESAL	W	0	Reset all bits when RESAL is set. Results in a state similar to a power-up reset. Note that the VDUV and VPUV bits (Supply Event register) follow the state of VDD and VPWR supply rails.
3–0	RESP4–RESP1	W	0	Reset channel bits. Used to force an immediate channel(s) turn off in any mode, by writing a 1 at the corresponding RESPn bit location(s). Note: For a 4-pair wired port, setting a RESPn bit for either channel will result in both channels being reset.

Setting the RESAL bit will result in all of the I2C register being restored to the RST condition with the exception of those in the following table:

Register	Bits	RESAL Result
0x00	All	Pre RESAL value will remain
0x0A/B	TSD, VPUV, VDWRN, and VPUV	
0x26	All	
0x2C and 0x2E	All	
0x41	All	

**NOTE**

Setting the RESAL bit for only one group of four channels (1-4 or 5-8) will result in only those four channels being reset.

**NOTE**

After using the CLINP command, the  $\overline{\text{INT}}$  pin will not be reasserted for any interrupts until all existing interrupts have been cleared.

Setting the RESP<sub>n</sub> bit will immediately turn off the associated channel and clear the registers according to the following table:

**Table 33. Channel Turn Off with RESP<sub>n</sub> Command**

Register	Bits to be Reset
0x04	CLSC <sub>n</sub> and DETC <sub>n</sub>
0x06	DISF <sub>n</sub> and PCUT <sub>n</sub>
0x08	STR <sub>Tn</sub> and ILIM <sub>n</sub>
0x0A/B	PCUT <sub>nn</sub>
0x0C-0F	Requested Class and Detection
0x10	PG <sub>n</sub> and PEn
0x14	CLE <sub>n</sub> and DETE <sub>n</sub>
0x1C	AC <sub>n</sub> and CC <sub>nn</sub>
0x1E-21	2P Policing set to 0xFFh
0x24	PF <sub>n</sub>
0x2A-2B	4P Policing set to 0xFFh
0x2D	NLM <sub>nn</sub> , NCT <sub>nn</sub> , 4PPCT <sub>nn</sub> , and DCDT <sub>nn</sub>
0x30-3F	Channel Voltage and Current Measurements
0x40	2xFB <sub>n</sub>
0x44 - 47	Detection Resistance Measurements
0x4C-4F	Assigned Class and Previous Class
0x51-54	Autoclass Measurement

**NOTE**

Only the bits associated with the channel/port ("n") with RESP<sub>n</sub> set will be cleared. Those bits associated with channels/ports remaining in operation will not be changed.

It may take upwards of 5 ms before all of the registers are cleared following a RESP<sub>n</sub> command.

The RESP<sub>n</sub> command will cancel any ongoing cool down cycles .

Users need to wait at least 3ms before trying to reenables discovery or power on ports following a RESP<sub>n</sub> command.

### 9.6.2.23 ID Register

COMMAND = 1Bh with 1 Data Byte, Read/Write

**Figure 67. ID Register Format**

7	6	5	4	3	2	1	0
MFR ID					ICV		
R/W-0	R/W-1	R/W-0	R/W-1	R/W-0	R/W-1	R/W-0	R/W-1

LEGEND: R/W = Read/Write; R = Read only; -n = value after reset

**Table 34. ID Register Field Descriptions**

Bit	Field	Type	Reset	Description
7–3	MFR ID	R/W	01010 b	Manufacture Identification number (0101,0)
2–0	ICV	R/W	101b	IC version number (011)

### 9.6.2.24 Connection Check and Auto Class Status Register

COMMAND = 1Ch with 1 Data Byte, Read Only

**Figure 68. Connection Check and Auto Class Register Format**

7	6	5	4	3	2	1	0
AC4	AC3	AC2	AC1	CC34_2	CC34_1	CC12_2	CC12_1
R-0	R-0	R-0	R-0	R-0	R-0	R-0	R-0

LEGEND: R/W = Read/Write; R = Read only; -n = value after reset

**Table 35. Connection Check and Auto Class Field Descriptions**

Bit	Field	Type	Reset	Description
7–4	ACn	R	0000b	Auto Class Detection Status 1 = PD supports Auto Class 0 = PD does not support Auto Class
3–2	CC34_2/1	R	00b	Connection Check result for 4-Pair port (channels 3 and 4)
1-0	CC12_2/1	R	00b	Connection Check result for 4-Pair port (channels 1 and 2)

#### Auto Class:

The auto class detection measurement is completed at the end of the long classification finger, and if a PD is determined to support auto class, an auto class power measurement will be automatically completed after turn on in accordance with the IEEE auto class timing requirements.

#### NOTE

The auto class function is operational regardless if a port is wired for 2-Pair or 4-Pair operation.

For 4-Pair single signature devices, both ACn bits will report the same result even though the classification measurement was completed on one channel.

An Auto Class power measurement will be completed shortly after power on for all channels that are found to support auto class during classification.

These measurement results are available in registers (0x51h – 0x54h), and the auto class power measurements are provide per individual channel.

#### Connection Check:

A connection check measurement will only be performed on 4-pair wired ports after at least one channel is found to have a valid detection result.

The results of connection check

CCnn_2	CCnn_1	CC Result
0	0	"unknown" or incomplete
0	1	Single Signature
1	0	Dual Signature
1	1	Reserved

These bits will be set following the completion of a connection check and prior to the setting of the Detection Event bits in the Detection Event register (0x04h).

### 9.6.2.25 2-Pair Police Ch-1 Configuration Register

COMMAND = 1Eh with 1 Data Byte, Read/Write

**Figure 69. 2-Pair Police Ch-1 Register Format**

7	6	5	4	3	2	1	0
POL1_7	POL1_6	POL1_5	POL1_5	POL1_3	POL1_2	POL1_1	POL1_0
R/W-1	R/W-1	R/W-1	R/W-1	R/W-1	R/W-1	R/W-1	R/W1

LEGEND: R/W = Read/Write; R = Read only; -n = value after reset

### 9.6.2.26 2-Pair Police Ch-2 Configuration Register

COMMAND = 1Fh with 1 Data Byte, Read/Write

**Figure 70. 2-Pair Police Ch-2 Register Format**

7	6	5	4	3	2	1	0
POL2_7	POL2_6	POL2_5	POL2_4	POL2_3	POL2_2	POL2_1	POL2_0
R/W-1	R/W-1	R/W-1	R/W-1	R/W-1	R/W-1	R/W-1	R/W1

LEGEND: R/W = Read/Write; R = Read only; -n = value after reset

### 9.6.2.27 2-Pair Police Ch-3 Configuration Register

COMMAND = 20h with 1 Data Byte, Read/Write

**Figure 71. 2-Pair Police Ch-3 Register Format**

7	6	5	4	3	2	1	0
POL3_7	POL3_6	POL3_5	POL3_5	POL3_3	POL3_2	POL3_1	POL3_0
R/W-1	R/W-1	R/W-1	R/W-1	R/W-1	R/W-1	R/W-1	R/W1

LEGEND: R/W = Read/Write; R = Read only; -n = value after reset

### 9.6.2.28 2-Pair Police Ch-4 Configuration Register

COMMAND = 21h with 1 Data Byte, Read/Write

**Figure 72. 2-Pair Police Ch-4 Register Format**

7	6	5	4	3	2	1	0
POL4_7	POL4_6	POL4_5	POL4_4	POL4_3	POL4_2	POL4_1	POL4_0
R/W-1	R/W-1	R/W-1	R/W-1	R/W-1	R/W-1	R/W-1	R/W1

LEGEND: R/W = Read/Write; R = Read only; -n = value after reset

**Table 36. 2-Pair Policing Register Fields Descriptions**

Bit	Field	Type	Reset	Description
7–0	POLn_7- POLn_0	R/W	1	1-byte defining 2-Pair P <sub>CUT</sub> <b>minimum</b> threshold. The equation defining the P <sub>CUT</sub> is: $P_{CUT} = (N \times PC_{STEP})$ Where, when assuming 0.200-Ω Rsense resistor is used: $PC_{STEP} = 0.5 W$

**NOTE**

These bits set the minimum threshold for the design. Internally, the typical PCUT threshold is set slightly above this value to ensure that the device does not trip a Pcut fault at or below the set value in this register due to part to part or temperature variation.

For 4-pair wired ports, the 2P Policing values are still applied to the individual channels. See the description for registers 0x2Ah and 0x2Bh for more information on 4-Pair Policing.

The contents of this register is reset to 0xFFh anytime the port is turned off or disabled either due to fault condition or user command

**NOTE**

Programmed values of less than 2W are not supported. If a value of less than 2W is programmed into these registers, the device will use 2W as the 2-pair Policing value.

**Power Policing:**

The TPS23881 implements a true Power Policing limit, where the device will adjust the policing limit based on both voltage and current variation in order to ensure a reliable power limit.

In Semi Auto and Auto modes, these bits are automatically set during power on based on the assigned class (see tables below). If an alternative value is desired, it needs to be set after the PEn bit is set in 0x10h, or it may also be configured prior to port turn on in combination with the use of the MPOLn bits in register 0x40 (see [2x FOLDBACK SELECTION Register](#)).

**Table 37. 2-Pair Policing Settings for 2-Pair Wired Ports and 4-Pair Dual Signature Devices**

Assigned Class	POLn7-0 Settings	Minimum Power
Class 1	0000 1000	4W
Class 2	0000 1110	7W
Class 3	0001 1111	15.5W
Class 4	0011 1100	30W
Class 5 Dual Signature	0101 1010	45W

**Table 38. 2-Pair Policing Settings for 4-Pair Wired Port with Single Signature Devices**

Assigned Class	POLn7-0 Settings	Minimum Power
Class 1	0000 1000	4W <sup>(1)</sup>
Class 2	0000 1110	7W <sup>(1)</sup>
Class 3	0001 1111	15.5W <sup>(1)</sup>
Class 4	0011 1100	30W <sup>(1)</sup>
Class 5	0100 0000	32W <sup>(2)</sup>
Class 6	0100 1110	39W <sup>(2)</sup>
Class 7	0101 1001	44.5W <sup>(2)</sup>
Class 8	0110 1011	53.5W <sup>(2)</sup>

- (1) Both channels of a 4-Pair port with a single signature device and an assigned class of 1-4 are required to support the full classification current per pair set.
- (2) 4-Pair ports with a single signature device and an assigned class of 5-8 are required to satisfy the IEEE load imbalance requirements for 4-Pair powered devices.

### 9.6.2.29 Capacitance (Legacy PD) Detection

COMMAND = 22h with 1 Data Byte, Write Only

Used to do enable capacitance measurement from Maunal mode

**Figure 73. Capacitance Detection Register Format**

7	6	5	4	3	2	1	0
-	CDET4	-	CDET3	-	CDET2	-	CDET1
R/W-0	R/W-0	R/W-0	R/W-0	R/W-0	R/W-0	R/W-0	R/W-0

LEGEND: R/W = Read/Write; R = Read only; W = Write only; -n = value after reset

**Table 39. Capacitance Detection Register Field Descriptions**

Bit	Field	Type	Reset	Description
7, 5, 3, 1	Reserved	R/W	0	
6, 4, 2, 0	CDETN	R/W	0	Enables Capacitance defection for channel "n" 0 = Capacitance defection disabled 1 = Capacitance detection enabled

To complete a capacitance measurement on a channel, the channel must first be placed into diagnostic mode. Set the bits in register 0x22h to enable capacitance detection on the channel(s) desired. Then set the DETE bits in register 0x14h to begin the detection and process.

**NOTE**

The TPS23881 SRAM needs to be programmed in order for the capacitance measurement to operate properly.

The capacitance measurement is only supported in Manual/Diagnostic mode.

No capacitance measurement will be made if the result of the resistance detection is returned as "valid".

For 4P wired ports, the capacitance measurement needs to be completed on each channel individually.

Upon completion of the capacitance measurement the DETCn bit will bet in register 0x04h, and the resistance and capacitance values will be updated in registers 0x44h - 0x4Bh.

### 9.6.2.30 Power-on Fault Register

COMMAND = 24h with 1 Data Byte, Read Only

COMMAND = 25h with 1 Data Byte, Clear on Read

**Figure 74. Power-on Fault Register Format**

7	6	5	4	3	2	1	0
PF4		PF3		PF2		PF1	
R-0	R-0	R-0	R-0	R-0	R-0	R-0	R-0
CR-0	CR-0	CR-0	CR-0	CR-0	CR-0	CR-0	CR-0

LEGEND: R/W = Read/Write; R = Read only; W = Write only; CR = Clear on Read; -n = value after reset

**Table 40. Power-on Fault Register Field Descriptions**

Bit	Field	Type	Reset	Description										
7–0	PF4–PF1	R or CR	0	Represents the fault status of the classification and detection for channel n, following a failed turn on attempt with the PWONn command. These bits are cleared when channel n is turned off. PFn: the selection is as follows: <table border="1" data-bbox="581 730 1076 905"> <thead> <tr> <th>Fault Code</th> <th>Power-on Fault Description</th> </tr> </thead> <tbody> <tr> <td>0 0</td> <td>No fault</td> </tr> <tr> <td>0 1</td> <td>Invalid detection</td> </tr> <tr> <td>1 0</td> <td>Classification Error</td> </tr> <tr> <td>1 1</td> <td>Insufficient Power</td> </tr> </tbody> </table>	Fault Code	Power-on Fault Description	0 0	No fault	0 1	Invalid detection	1 0	Classification Error	1 1	Insufficient Power
Fault Code	Power-on Fault Description													
0 0	No fault													
0 1	Invalid detection													
1 0	Classification Error													
1 1	Insufficient Power													

#### NOTE

When a Start Fault occurs and the PECn bit is not set, then this register will indicate the cause of the fault.

An insufficient power fault is reported anytime the reg 0x29 configuration will not allow a channel to be powered. See the section describing [Power Allocation and Power Demotion](#).

For 4-pair wired Ports:

Thee bits will be updated **individually** for dual signature connected devices

Thee bits will be updated **concurrently** for single signature connected devices



**9.6.2.31 PORT RE-MAPPING Register**

COMMAND = 26h with 1 Data Byte, Read/Write

**Figure 75. PORT RE-MAPPING Register Format**

7	6	5	4	3	2	1	0
Physical Channel # of Logical Channel 4		Physical Channel # of Logical Channel 3		Physical Channel # of Logical Channel 2		Physical Channel # of Logical Channel 1	
R/W-1	R/W-1	R/W-1	R/W-0	R/W-0	R/W-1	R/W-0	R/W-0

LEGEND: R/W = Read/Write; R = Read only; W = Write only; CR = Clear on Read; -n = value after reset

**Table 41. PORT RE-MAPPING Register Field Descriptions**

Bit	Field	Type	POR / RST	Description																				
7–0	Physical Channel # of Logical Channel n	R/W	1110 0100b / P	<p>Used to re-map channels logically due to physical board constraints. Re-mapping is between any channel within 4-channel group (1-4 or 5-8). All channels of a group of four must be in OFF mode prior to receiving the port re-mapping command, otherwise the command will be ignored. By default there is no re-mapping.</p> <p>Each pair of bits corresponds to the logical port assigned. The selection per port is as follows:</p> <table border="1" style="margin-left: 20px;"> <thead> <tr> <th colspan="2">Re-Map Code</th> <th>Physical Channel</th> <th>Package Pins</th> </tr> </thead> <tbody> <tr> <td style="text-align: center;">0</td> <td style="text-align: center;">0</td> <td style="text-align: center;">1</td> <td>Drain1,Gat1,Sen1</td> </tr> <tr> <td style="text-align: center;">0</td> <td style="text-align: center;">1</td> <td style="text-align: center;">2</td> <td>Drain2,Gat2,Sen2</td> </tr> <tr> <td style="text-align: center;">1</td> <td style="text-align: center;">0</td> <td style="text-align: center;">3</td> <td>Drain3,Gat3,Sen3</td> </tr> <tr> <td style="text-align: center;">1</td> <td style="text-align: center;">1</td> <td style="text-align: center;">4</td> <td>Drain4,Gat4,Sen4</td> </tr> </tbody> </table> <p>When there is no re-mapping the default value of this register is 1110,0100. The 2 MSbits with a value 11 indicate that logical channel 4 is mapped onto physical channel #4, the next 2 bits, 10, suggest logical channel 3 is mapped onto physical channel #3 and so on.</p> <p>Note: Code duplication is not allowed – that is, the same code cannot be written into the remapping bits of more than one port – if such a value is received, it will be ignored and the chip will stay with existing configuration.</p> <p>Note: Port remapping configuration is kept unchanged if 0x1A IC reset command is received.</p>	Re-Map Code		Physical Channel	Package Pins	0	0	1	Drain1,Gat1,Sen1	0	1	2	Drain2,Gat2,Sen2	1	0	3	Drain3,Gat3,Sen3	1	1	4	Drain4,Gat4,Sen4
Re-Map Code		Physical Channel	Package Pins																					
0	0	1	Drain1,Gat1,Sen1																					
0	1	2	Drain2,Gat2,Sen2																					
1	0	3	Drain3,Gat3,Sen3																					
1	1	4	Drain4,Gat4,Sen4																					

**NOTE**

The RST condition of "P" indicates that the previous state of these bits will be preserved following a device reset using the RESET pin. Thus, pulling the RESET input low will not overwrite any user changes to this register.

**NOTE**

**Only logical Channels 3 and 4 and 1 and 2 may be wired as 4-pair Ports. Unpredictable behavior will occur if any other combinations of logical Channels are wired in a 4-pair configuration.**

**NOTE**

After port remapping, TI recommends to do at least one detection-classification cycle before turn on.

### 9.6.2.32 Channels 1 and 2 Multi Bit Priority Register

COMMAND = 27h with 1 Data Byte, Read/Write .

**Figure 76. Channels 1 and 2 MBP Register Format**

7	6	5	4	3	2	1	0
–	MBP2_2	MBP2_1	MBP2_0	–	MBP1_2	MBP1_1	MBP1_0
R/W-0	R/W-0	R/W-0	R/W-0	R/W-0	R/W-0	R/W-0	R/W-0

LEGEND: R/W = Read/Write; R = Read only; -n = value after reset

### 9.6.2.33 Channels 3 and 4 Multi Bit Priority Register

COMMAND = 28h with 1 Data Byte, Read/Write

**Figure 77. Channels 3 and 4 MBP Register Format**

7	6	5	4	3	2	1	0
–	MBP4_2	MBP4_1	MBP4_0	–	MBP3_2	MBP3_1	MBP3_0
R/W-0	R/W-0	R/W-0	R/W-0	R/W-0	R/W-0	R/W-0	R/W-0

LEGEND: R/W = Read/Write; R = Read only; -n = value after reset

**Table 42. Channels n MBP Register Field Descriptions**

Bit	Field	Type	Reset	Description																																								
7–0	MBPn_2-0	R/W	0	<p>MBPn_2-0: Multi Bit Priority bits, three bits per channel, if 3-bit shutdown priority has been selected (MbitPrty in General Mask register is high). It is used to determine which channel(s) is (are) shut down in response to a serial shutdown code received at the OSS shutdown input.</p> <p>The turn off procedure (including register bits clearing) is similar to a channel reset using Reset command (1Ah register), except that it does not cancel any ongoing fault cool down time count.</p> <p>The priority is defined as followings:</p> <p>OSS code ≤ MBPn_2-0 : when the OSS code is received, the corresponding channel is powered off.</p> <p>OSS code &gt; MBPn_2-0 : OSS code has no impact on the channel</p> <table border="1" data-bbox="560 1192 1372 1495"> <thead> <tr> <th colspan="3">MBPn_2-0 0x27/28 Register</th> <th>Multi Bit Priority</th> <th>OSS Code for Channel Off</th> </tr> </thead> <tbody> <tr> <td>0</td> <td>0</td> <td>0</td> <td>Highest</td> <td>OSS = '000'</td> </tr> <tr> <td>0</td> <td>0</td> <td>1</td> <td>2</td> <td>OSS = '000' or '001'</td> </tr> <tr> <td>0</td> <td>1</td> <td>0</td> <td>3</td> <td>OSS ≤ '010'</td> </tr> <tr> <td>0</td> <td>1</td> <td>1</td> <td>4</td> <td>OSS ≤ '011'</td> </tr> <tr> <td>1</td> <td>0</td> <td>0</td> <td>5</td> <td>OSS ≤ '100'</td> </tr> <tr> <td>1</td> <td>0</td> <td>1</td> <td>6</td> <td>OSS = any code except '111'</td> </tr> <tr> <td>1</td> <td>1</td> <td>1</td> <td>Lowest</td> <td>OSS = any code</td> </tr> </tbody> </table>	MBPn_2-0 0x27/28 Register			Multi Bit Priority	OSS Code for Channel Off	0	0	0	Highest	OSS = '000'	0	0	1	2	OSS = '000' or '001'	0	1	0	3	OSS ≤ '010'	0	1	1	4	OSS ≤ '011'	1	0	0	5	OSS ≤ '100'	1	0	1	6	OSS = any code except '111'	1	1	1	Lowest	OSS = any code
MBPn_2-0 0x27/28 Register			Multi Bit Priority	OSS Code for Channel Off																																								
0	0	0	Highest	OSS = '000'																																								
0	0	1	2	OSS = '000' or '001'																																								
0	1	0	3	OSS ≤ '010'																																								
0	1	1	4	OSS ≤ '011'																																								
1	0	0	5	OSS ≤ '100'																																								
1	0	1	6	OSS = any code except '111'																																								
1	1	1	Lowest	OSS = any code																																								

The priority reduces as the 3-bit value increases. Thus, a channel with a "000" setting has the highest priority, while one with a "111" setting has the lowest.

It is permissible to apply the same settings to multiple channels. Doing so will result in all channels with the same setting will be disabled when the appropriate OSS code is presented.

For 4-pair wired Ports, these bits control the individual Channel response. In order for both pair sets of a 4-pair wire Port to be disabled, both channels need to have the same MBP setting otherwise it is possible for only one pair set to be disabled.

In the event a singular channel of a 4-pair dual signature PD is turned off due to OSS or other reason, power may be reapplied to that channel by setting the PWON bit in 0x19h provided the detection and classification are still valid and the Power Allocation settings in 0x29 are sufficient based on the assigned classification of the powered channel.

The turn off procedure due to OSS is similar to a channel reset or change to OFF mode, with the exception that OSS does not cancel any ongoing fault cool down timers. The table below includes the bits that will be cleared when a channel is disabled due to OSS:

**Table 43. Channel Turn Off with MBP OSS**

Register	Bits to be Reset
0x04	CLSCn and DETCn
0x06	DISFn and PCUTn
0x08	STRn and ILIMn
0x0A/B	PCUTnn
0x0C-0F	Requested Class and Detection
0x10	PGn and PEn
0x14	CLEn and DETEn
0x1C	ACn and CCnn
0x1E-21	2P Policing set to 0xFFh
0x24	PFn
0x2A-2B	4P Policing set to 0xFFh
0x2D	NLMnn, NCTnn, 4PPCTnn, and DCDTnn
0x30-3F	Channel Voltage and Current Measurements
0x40	2xFBn
0x44 - 47	Detection Resistance Measurements
0x4C-4F	Assigned Class and Previous Class
0x51-54	Autoclass Measurement

---

**NOTE**

There is no memory of any preceding 3-bit OSS commands. Each 3-bit OSS command is processed immediately (prior to the end of the last OSS MBP pulse) based on the MBPn settings for each Channel. Any attempt to shutdown additional Channels thereafter will require additional 3-bit OSS commands.

---

**9.6.2.34 4-Pair Wired and Port Power Allocation Register**

COMMAND = 29h with 1 Data Byte, Read/Write

**Figure 78. 4-Pair Wired and Power Allocation Register Format**

7	6	5	4	3	2	1	0
4PW34	MC34_2	MC34_1	MC34_0	4PW12	MC12_2	MC12_1	MC12_0
R/W-0	R/W-0	R/W-0	R/W-0	R/W-0	R/W-0	R/W-0	R/W-0

LEGEND: R/W = Read/Write; R = Read only; -n = value after reset

**Table 44. 4-Pair Wired and Power Allocation Register Field Descriptions**

Bit	Field	Type	Reset	Description
7, 3	4PWnn	R/W	0	4-Pair wired configuration bits 4PWnn = 1: Channels 3/4 or 1/2 are wired in a 4-pair configuration 4PWnn = 0: Channels 3/4 or 1/2 are wired in 2-pair configurations
6 - 4, 2 - 0	MCnn_2-0	R/W	0	MCnn_2-0: Port Power Allocation bits. These bits set the maximum power classification level that a given Port (2-Pair or 4-Pair) is allowed to power on In Semi Auto mode these bits need to be set prior to issuing a PWONn command, while in Auto mode these bits need to be set prior to setting the DETE and CLE bits in 0x14.

**Table 45. 4-Pair Wired and Power Allocation Settings**

4PWnn	MCnn_2	MCnn_1	MCnn_0	Power Allocation
0	0	0	0	2-Pair 15.4W
0	0	0	1	Reserved
0	0	1	0	Reserved
0	0	1	1	2-Pair 30W
0	1	x	x	Reserved
1	0	0	0	4-Pair 15.4W
1	0	0	1	Reserved
1	0	1	0	Reserved
1	0	1	1	4-Pair 30W (Class 4)
1	1	0	0	4-Pair 45W (Class 5)
1	1	0	1	4-Pair 60W (Class 6)
1	1	1	0	4-Pair 75W (Class 7)
1	1	1	1	4-Pair 90W (Class 8)

Refer to [Table 1](#) and [Table 2](#) for more details on the application of Power Demotion and the relationship between the Power Allocation settings and the resulting Assigned Class.

**NOTE**

In order to prevent any unexpected behavior the setting the 4PWnn bits should only be done immediately following a Power On Reset (POR) event while the ports are still in OFF mode.

**NOTE**

The Power Allocation (0x29h) value needs to be set prior to issuing a PWON command in Semi Auto or Auto modes, and prior to setting the DETE and CLE bits in Auto mode. Any changes to the Power Allocation value after a PWON command is given may be ignored.

**NOTE**

For 4-pair dual signature PDs, the odd numbered Channels takes priority over the even numbered Channels. Thus, an even numbered Channel will be powered based on the difference between the total power allocated and what the odd Channel classified as.

For example if a dual signature PD contained two 45W PDs and the PSEs power allocation was set to 60W, the odd numbered Channel will be powered at 45W while the even numbered Channel will be limited to 15W.

---

**NOTE**

For 2-Pair wired ports, the MCnn\_2-0 bits set the power allocation settings for both channels 1 and 2 and 3 and 4 concurrently.

It is possible to have channels 3 and 4 set to 15.4W while channels 1 and 2 are set to 30W, but it is not possible to have different power allocation settings between channels 1 and 2 or 3 and 4

---

### 9.6.2.35 4-Pair Police Ch-1 and 2 Configuration Register

COMMAND = 2Ah with 1 Data Byte, Read/Write

**Figure 79. 4-Pair Police Ch-1 and 2 Configuration Register Format**

7	6	5	4	3	2	1	0
POL12_7	POL12_6	POL12_5	POL12_4	POL12_3	POL12_2	POL12_1	POL12_0
R/W-1	R/W-1	R/W-1	R/W-1	R/W-1	R/W-1	R/W-1	R/W1

LEGEND: R/W = Read/Write; R = Read only; -n = value after reset

### 9.6.2.36 4-Pair Police Ch-3 and 4 Configuration Register

COMMAND = 2Bh with 1 Data Byte, Read/Write

**Figure 80. 4-Pair Police Ch-3 and 4 Configuration Register Format**

7	6	5	4	3	2	1	0
POL34_7	POL34_6	POL34_5	POL34_4	POL34_3	POL34_2	POL34_1	POL34_0
R/W-1	R/W-1	R/W-1	R/W-1	R/W-1	R/W-1	R/W-1	R/W1

LEGEND: R/W = Read/Write; R = Read only; -n = value after reset

**Table 46. 4-Pair Police Register Field Descriptions**

Bit	Field	Type	Reset	Description
7–0	POLnn_7- POLnn_0	R/W	1	1-byte defining the <b>summed</b> 4-Pair P <sub>CUT</sub> <b>minimum</b> threshold. The equation defining the P <sub>CUT</sub> is: $P_{CUT} = (N \times PC_{STEP})$ Where, when assuming 0.200-Ω R <sub>sense</sub> resistor is used: $PC_{STEP} = 0.5 W$

#### NOTE

These bits set the minimum threshold for the design. Internally, the typical P<sub>CUT</sub> threshold is set slightly above this value to ensure that the device does not trip a P<sub>cut</sub> fault at or below the set value in this register due to part to part or temperature variation.

For 4-pair wired, the 2P Policing values are still applied to the individual Channels. See the description for registers 0x1Eh through 0x21h for more information on 2-Pair Policing.

The contents of this register is reset to 0xFFh anytime the port is turned off or disabled either due to fault condition or user command

#### NOTE

Programmed values of less than 4W are not supported. If a value of less than 4W is programmed into these registers, the device will use 4W as the 4-pair Policing value.

#### 4-Pair Power Policing:

The TPS23881 implements a true Power Policing limit, where the device will adjust the policing limit based on both voltage and sum of current variation in order to ensure a reliable power limit.

In Semi Auto and Auto modes, these bits are automatically set during power on based on the assigned class (see [Table 47](#)). If an alternative value is desired, it needs to be set after the PEn bit is set in register 0x10h, or it may also be configured prior to port turn on in combination with the use of the MPOLn bits in register 0x40 (see [2x FOLDBACK SELECTION Register](#)).

**Table 47. 4-Pair Policing Settings for 4-Pair Wired Port with Single Signature Devices**

Assigned Class	POLnn7-0 Settings	Minimum Power
Class 1	0000 1000	4W
Class 2	0000 1110	7W
Class 3	0001 1111	15.5W
Class 4	0011 1100	30W
Class 5	0101 1010	45W
Class 6	0111 1000	60W
Class 7	1001 0110	75W
Class 8	1011 0100	90W

For a 4-pair dual signature devices, these values will be set based on the sum of the assigned classes of both channels, but 4P PCut will be disabled (4PPCTnn bit in 0x2D = 0) by default as the primary policing method for dual signature devices will be the 2-Pair values defined in registers 0x1Eh - 0x21h.

Setting the 4PPCTnn bit in 0x2D will enable 4P Policing if desired.

---

**NOTE**

The  $t_{OVL D}$  time for 4-pair Pcut faults will be equal to the  $t_{OVL D}$  setting + approximately 6 ms

---

### 9.6.2.37 TEMPERATURE Register

COMMAND = 2Ch with 1 Data Byte, Read Only

**Figure 81. TEMPERATURE Register Format**

7	6	5	4	3	2	1	0
TEMP7	TEMP6	TEMP5	TEMP4	TEMP3	TEMP2	TEMP1	TEMP0
R-0	R-0	R-0	R-0	R-0	R-0	R-0	R-0

LEGEND: R/W = Read/Write; R = Read only; -n = value after reset

**Table 48. TEMPERATURE Register Field Descriptions**

Bit	Field	Type	Reset	Description						
7–0	TEMP7–TEMP0	R	0	<p>Bit Descriptions: Data conversion result. The I<sup>2</sup>C data transmission is a 1-byte transfer. 8-bit Data conversion result of temperature, from –20°C to 125°C. The update rate is around once per second.</p> <p>The equation defining the temperature measured is:</p> $T = -20 + N \times T_{STEP}$ <p>Where T<sub>STEP</sub> is defined below as well as the full scale value:</p> <table border="1" data-bbox="657 751 1200 825"> <thead> <tr> <th>Mode</th> <th>Full Scale Value</th> <th>T<sub>STEP</sub></th> </tr> </thead> <tbody> <tr> <td>Any</td> <td>146.2°C</td> <td>0.652°C</td> </tr> </tbody> </table>	Mode	Full Scale Value	T <sub>STEP</sub>	Any	146.2°C	0.652°C
Mode	Full Scale Value	T <sub>STEP</sub>								
Any	146.2°C	0.652°C								



**9.6.2.38 4-Pair Fault Configuration Register**

COMMAND = 2Dh with 1 Data Byte, Read/Write

**Figure 82. 4-Pair Fault Configuration Register Format**

7	6	5	4	3	2	1	0
NLM34	NLM12	NCT34	NCT12	4PPCT34	4PPCT12	DCDT34	DCDT12
R/W-0	R/W-0	R/W-0	R/W-0	R/W-0	R/W-0	R/W-0	R/W-0

LEGEND: R/W = Read/Write; R = Read only; -n = value after reset

**Table 49. 4-Pair Fault Register Field Descriptions**

Bit	Field	Type	Reset	Description
7 , 6	NLMnn	R/W	0	4-Pair ILIM Fault Management bits 1 = <b>Both</b> channels on a 4-Pair wired port will be disabled if an ILIM fault occurs on either channel 0 = Only the channel on which the ILIM fault occurred will be disabled. The alternative channel will remain powered. In Auto mode these bits will be automatically set after turn on if a 4-Pair Single Signature device is powered
5 , 4	NCTnn	R/W	0	4-Pair PCUT Fault Management bits 1 = <b>Both</b> channels on a 4-Pair wired port will be disabled if a 2-Pair P <sub>CUT</sub> fault occurs on either channel 0 = Only the channel on which the 2-Pair P <sub>CUT</sub> fault occurred will be disabled. The alternative channel will remain powered. In Auto mode these bits will be automatically set after turn on if a 4-Pair Single Signature device is powered
3 , 2	4PPCTnn	R/W	0	4-Pair Summed PCUT Enable bits 1 = Summed 4-Pair PCut is enabled 0 = Summed 4-Pair PCut is disabled The hardware continue to monitor for ILIM faults independent of these bits In either Auto and Semi Auto modes, these bits will be automatically set to a "1" after turn on if a 4-Pair Single Signature device is powered
1 , 0	DCDTnn	R/W	0	DC Disconnect Threshold bits 1 = DC disconnect Threshold set to 4.5mA typical 0 = DC disconnect Threshold set to 6.5mA typical For 4-pair Dual Signature PDs, the DCDTxx bit will be set to "1" during turn on and the disconnect threshold will be applied independently per Channel. Thus, if either channel falls below the 4.5mA threshold for the duration of TMPDO + TMPS, only that channel will be disabled while the alternative channel remains powered as long it satisfies. For 4-pair single signature PDs (see register 0x1Ch), these bits are internally set during power on based on the assigned class (0x4C-4F): Assigned Classes 1-4: DCDTxx = 0 Assigned Classes 5-8: DCDTxx = 1

**NOTE**

**Partial Disconnect:** For 4-pair single signature PDs with DCDTxx = 0 and an Assigned Class = 0-4, one pair set/channel will be immediately disabled when either channel falls below the DC Disconnect threshold to improve the low current measurement accuracy. The second channel will remain powered as long as the current drawn by the load satisfies the MPS timing and current requirements. The disabled channel will be re-enabled when the single channel current increases above 75 mA.

---

**NOTE**

4-pair Pcut is disabled whenever a 4-pair port is either in a partial disconnect state or one or both channel currents are below 30mA (typ).

---

---

**NOTE**

For 4-pair single signature PDs with DCDTxx = 1 and an Assigned Class = 5-8, **both** channels will remain powered until the current on both channels fall below the 4.5mA threshold for the duration of TMPDO + TMPS.

---

---

**NOTE**

Setting DCDTxx = "0" for a 4P Dual Signature PD or 4P Single Signature PD with assigned class = 5-8 after turn on will result in the use of the 6.5mA threshold per channel which is **non-compliant** to the 802.3bt standard.

---

---

**NOTE**

For 4-pair Dual Signature PDs, the disconnect threshold will be applied independently per channel. Thus, if either channel falls below the disconnect threshold for the duration of TMPDO + TMPS, only that channel will be disabled while the alternative channel remains powered as long it continues to satisfy the MPS timing and current requirements.

---

---

**NOTE**

DC Disconnect for 4-Pair ports power on in Manual/Diagnostic mode will behave as independent channels. Thus, if either channel current falls below  $V_{IMIN}$  for longer than  $t_{MPDO}$ , that channel will be disabled and a disconnect fault will be set (DISFn bits in register 0x06/7).

---

**9.6.2.39 INPUT VOLTAGE Register**

COMMAND = 2Eh with 2 Data Byte (LSByte first, MSByte second), Read only

**Figure 83. INPUT VOLTAGE Register Format**

7	6	5	4	3	2	1	0
<b>LSB:</b>							
VPWR7	VPWR6	VPWR5	VPWR4	VPWR3	VPWR2	VPWR1	VPWR0
R-0	R-0	R-0	R-0	R-0	R-0	R-0	R-0
<b>MSB:</b>							
–	–	VPWR13	VPWR12	VPWR11	VPWR10	VPWR9	VPWR8
R-0	R-0	R-0	R-0	R-0	R-0	R-0	R-0

LEGEND: R/W = Read/Write; R = Read only; -n = value after reset

**Table 50. INPUT VOLTAGE Register Field Descriptions**

Bit	Field	Type	Reset	Description						
13–0	VPWR13- VPWR0	R	0	<p>Bit Descriptions: Data conversion result. The I<sup>2</sup>C data transmission is a 2-byte transfer. 14-bit Data conversion result of input voltage.</p> <p>The equation defining the voltage measured is:</p> $V = N \times V_{STEP}$ <p>Where V<sub>STEP</sub> is defined below as well as the full scale value:</p> <table border="1" data-bbox="647 856 1117 928"> <thead> <tr> <th>Mode</th> <th>Full Scale Value</th> <th>V<sub>STEP</sub></th> </tr> </thead> <tbody> <tr> <td>Any</td> <td>60 V</td> <td>3.662 mV</td> </tr> </tbody> </table> <p>Note that the measurement is made between VPWR and AGND.</p>	Mode	Full Scale Value	V <sub>STEP</sub>	Any	60 V	3.662 mV
Mode	Full Scale Value	V <sub>STEP</sub>								
Any	60 V	3.662 mV								

**9.6.2.40 CHANNEL 1 CURRENT Register**

COMMAND = 30h with 2 Data Byte, (LSByte First, MSByte second), Read Only

**Figure 84. CHANNEL 1 CURRENT Register Format**

7	6	5	4	3	2	1	0
<b>LSB:</b>							
I1_7	I1_6	I1_5	I1_4	I1_3	I1_2	I1_1	I1_0
R-0	R-0	R-0	R-0	R-0	R-0	R-0	R-0
<b>MSB:</b>							
–	–	I1_13	I1_12	I1_11	I1_10	I1_9	I1_8
R-0	R-0	R-0	R-0	R-0	R-0	R-0	R-0

LEGEND: R/W = Read/Write; R = Read only; -n = value after reset

**9.6.2.41 CHANNEL 2 CURRENT Register**

COMMAND = 34h with 2 Data Byte, (LSByte First, MSByte second), Read Only

**Figure 85. CHANNEL 2 CURRENT Register Format**

7	6	5	4	3	2	1	0
<b>LSB:</b>							
I2_7	I2_6	I2_5	I2_4	I2_3	I2_2	I2_1	I2_0
R-0	R-0	R-0	R-0	R-0	R-0	R-0	R-0
<b>MSB:</b>							
–	–	I2_13	I2_12	I2_11	I2_10	I2_9	I2_8
R-0	R-0	R-0	R-0	R-0	R-0	R-0	R-0

LEGEND: R/W = Read/Write; R = Read only; -n = value after reset

**9.6.2.42 CHANNEL 3 CURRENT Register**

COMMAND = 38h with 2 Data Byte, (LSByte First, MSByte second), Read Only

**Figure 86. CHANNEL 3 CURRENT Register Format**

7	6	5	4	3	2	1	0
<b>LSB:</b>							
I3_7	I3_6	I3_5	I3_4	I3_3	I3_2	I3_1	I3_0
R-0	R-0	R-0	R-0	R-0	R-0	R-0	R-0
<b>MSB:</b>							
–	–	I3_13	I3_12	I3_11	I3_10	I3_9	I3_8
R-0	R-0	R-0	R-0	R-0	R-0	R-0	R-0

LEGEND: R/W = Read/Write; R = Read only; -n = value after reset

**9.6.2.43 CHANNEL 4 CURRENT Register**

COMMAND = 3Ch with 2 Data Byte, (LSByte First, MSByte second), Read Only

**Figure 87. CHANNEL 4 CURRENT Register Format**

7	6	5	4	3	2	1	0
<b>LSB:</b>							
I4_7	I4_6	I4_5	I4_4	I4_3	I4_2	I4_1	I4_0
R-0	R-0	R-0	R-0	R-0	R-0	R-0	R-0
<b>MSB:</b>							
–	–	I4_13	I4_12	I4_11	I4_10	I4_9	I4_8
R-0	R-0	R-0	R-0	R-0	R-0	R-0	R-0

LEGEND: R/W = Read/Write; R = Read only; -n = value after reset

**Table 51. CHANNEL n CURRENT Register Field Descriptions**

Bit	Field	Type	Reset	Description						
13-0	In_13- In_0	R	0	<p>Bit Descriptions: Data conversion result. The I<sup>2</sup>C data transmission is a 2-byte transfer. Note that the conversion is done using a TI proprietary multi-slope integrating converter.</p> <p>14-bit Data conversion result of current for channel n. The update rate is around once per 100 ms in powered state.</p> <p>The equation defining the current measured is:</p> $I = N \times I_{STEP}$ <p>Where I<sub>STEP</sub> is defined below as well as the full scale value, according to the operating mode:</p> <table border="1" style="margin-left: auto; margin-right: auto;"> <thead> <tr> <th>Mode</th> <th>Full Scale Value</th> <th>I<sub>STEP</sub></th> </tr> </thead> <tbody> <tr> <td>Powered and Classification</td> <td>1.46 A (with 0.200-Ω R<sub>sense</sub>)</td> <td>89.5 μA</td> </tr> </tbody> </table> <p>Note: in any of the following cases, the result through I<sup>2</sup>C interface is automatically 0000</p> <ul style="list-style-type: none"> <li>channel is in OFF mode</li> <li>channel is OFF while in semiauto mode and detect/class is not enabled</li> <li>channel is OFF while in semiauto mode and detection result is incorrect</li> </ul> <p>In diagnostic/manual mode, if detect/class has been enabled at least once, the register retains the result of the last measurement</p>	Mode	Full Scale Value	I <sub>STEP</sub>	Powered and Classification	1.46 A (with 0.200-Ω R <sub>sense</sub> )	89.5 μA
Mode	Full Scale Value	I <sub>STEP</sub>								
Powered and Classification	1.46 A (with 0.200-Ω R <sub>sense</sub> )	89.5 μA								

---

**NOTE**

1.46A is the theoretical full scale range of the ADC based on 14bits \* Istep. However, due to the 1.25A channel current limit, the channel current will foldback and be disabled when the current exceeds the ILIM-2X threshold (V<sub>LIM2X</sub>).

---



---

**NOTE**

For 4-Pair wired ports, these registers still only provide the individual per channel current measurements. The value from both channels need to be added together in order to get the total 4-pair port current reading.

---

**Class Current Reading**

Following the completion of any classification measurement on a channel, the measured classification current is reported in these registers until either a port current reading is completed following a port turn on or the port is disabled.

---

**NOTE**

Only the current measurement for the last classification finger is reported. Thus, for a single signature Class 5, 6, 7, and 8 PDs, the reported classification current will report a Class 0, 1, 2, & 3 current level respectively.

---

**NOTE**

The scaling factor for the class current reading is decreased by a factor of 10x to 8.95uA/bit.

---

### 9.6.2.44 CHANNEL 1 VOLTAGE Register

COMMAND = 32h with 2 Data Byte, (LSByte First, MSByte second), Read Only

Figure 88. CHANNEL 1 VOLTAGE Register Format

7	6	5	4	3	2	1	0
<b>LSB:</b>							
V1_7	V1_6	V1_5	V1_4	V1_3	V1_2	V1_1	V1_0
R-0	R-0	R-0	R-0	R-0	R-0	R-0	R-0
<b>MSB:</b>							
–	–	V1_13	V1_12	V1_11	V1_10	V1_9	V1_8
R-0	R-0	R-0	R-0	R-0	R-0	R-0	R-0

LEGEND: R/W = Read/Write; R = Read only; -n = value after reset

### 9.6.2.45 CHANNEL 2 VOLTAGE Register

COMMAND = 36h with 2 Data Byte, (LSByte First, MSByte second), Read Only

Figure 89. CHANNEL 2 VOLTAGE Register Format

7	6	5	4	3	2	1	0
<b>LSB:</b>							
V2_7	V2_6	V2_5	V2_4	V2_3	V2_2	V2_1	V2_0
R-0	R-0	R-0	R-0	R-0	R-0	R-0	R-0
<b>MSB:</b>							
–	–	V2_13	V2_12	V2_11	V2_10	V2_9	V2_8
R-0	R-0	R-0	R-0	R-0	R-0	R-0	R-0

LEGEND: R/W = Read/Write; R = Read only; -n = value after reset

### 9.6.2.46 CHANNEL 3 VOLTAGE Register

COMMAND = 3Ah with 2 Data Byte, (LSByte First, MSByte second), Read Only

Figure 90. CHANNEL 3 VOLTAGE Register Format

7	6	5	4	3	2	1	0
<b>LSB:</b>							
V3_7	V3_6	V3_5	V3_4	V3_3	V3_2	V3_1	V3_0
R-0	R-0	R-0	R-0	R-0	R-0	R-0	R-0
<b>MSB:</b>							
–	–	V3_13	V3_12	V3_11	V3_10	V3_9	V3_8
R-0	R-0	R-0	R-0	R-0	R-0	R-0	R-0

LEGEND: R/W = Read/Write; R = Read only; -n = value after reset

### 9.6.2.47 CHANNEL 4 VOLTAGE Register

COMMAND = 3Eh with 2 Data Byte, (LSByte First, MSByte second), Read Only

Figure 91. CHANNEL 4 VOLTAGE Register Format

7	6	5	4	3	2	1	0
<b>LSB:</b>							
V4_7	V4_6	V4_5	V4_4	V4_3	V4_2	V4_1	V4_0
R-0	R-0	R-0	R-0	R-0	R-0	R-0	R-0
<b>MSB:</b>							
–	–	V4_13	V4_12	V4_11	V4_10	V4_9	V4_8
R-0	R-0	R-0	R-0	R-0	R-0	R-0	R-0

LEGEND: R/W = Read/Write; R = Read only; -n = value after reset

**Table 52. CHANNEL n VOLTAGE Register Field Descriptions**

Bit	Field	Type	Reset	Description						
13-0	Vn_13- Vn_0	R	0	<p>Bit Descriptions: Data conversion result. The I<sup>2</sup>C data transmission is a 2-byte transfer. The equation defining the voltage measured is:</p> $V = N \times V_{STEP}$ <p>Where V<sub>STEP</sub> is defined below as well as the full scale value:</p> <table border="1" data-bbox="630 424 1208 495"> <thead> <tr> <th>Mode</th> <th>Full Scale Value</th> <th>V<sub>STEP</sub></th> </tr> </thead> <tbody> <tr> <td>Powered</td> <td>60 V</td> <td>3.662 mV</td> </tr> </tbody> </table> <p>Note that a powered voltage measurement is made between VPWR and DRAINn.            Note: if a channel is OFF, the result through I<sup>2</sup>C interface is automatically 0000.</p>	Mode	Full Scale Value	V <sub>STEP</sub>	Powered	60 V	3.662 mV
Mode	Full Scale Value	V <sub>STEP</sub>								
Powered	60 V	3.662 mV								

**9.6.2.48 2x FOLDBACK SELECTION Register**

COMMAND = 40h with 1 Data Byte Read/Write

**Figure 92. 2x FOLDBACK SELECTION Register Format**

7	6	5	4	3	2	1	0
2xFB4	2xFB3	2xFB2	2xFB1	MPOL4	MPOL3	MPOL2	MPOL1
R/W-0	R/W-0	R/W-0	R/W-0	R/W -0	R/W -0	R/W -0	R/W -0

LEGEND: R/W = Read/Write; R = Read only; -n = value after reset

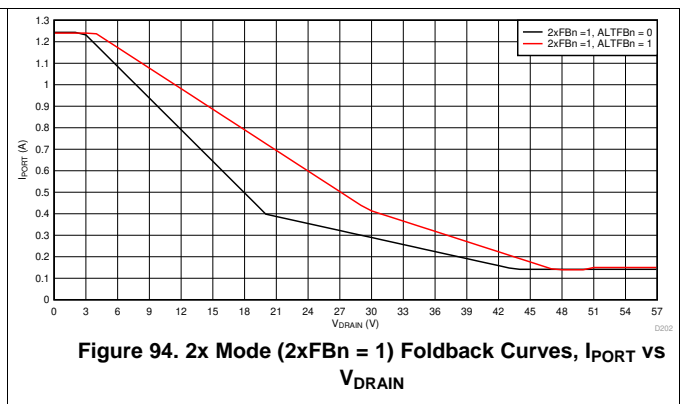
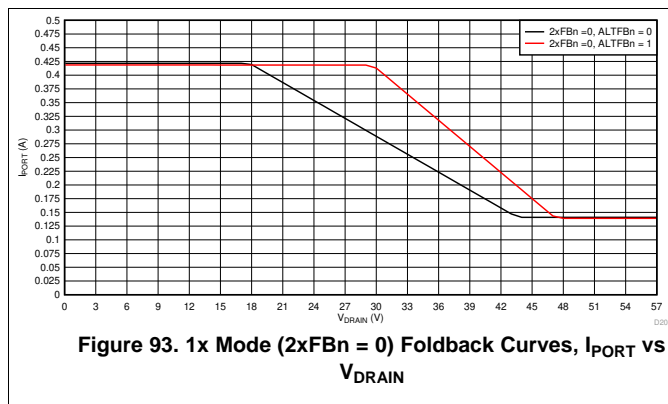
**Table 53. 2x FOLDBACK SELECTION Register Field Descriptions**

Bit	Field	Type	Reset	Description
7-4	2xFB4- 2xFB1	R/W	0	<p>When set, this activates the 2x Foldback mode for a channel which increases its <math>I_{LIM}</math> and <math>I_{SHORT}</math> levels normal settings, as shown in Figure 40. Note that the fault timer starts when the <math>I_{LIM}</math> threshold is exceeded.</p> <p>Notes:</p> <ol style="list-style-type: none"> <li>1) At turn on, the inrush current profile is unaffected by these bits, as shown in Figure 39.</li> <li>2) When a 2xFBn bit is deasserted, the <math>t_{LIM}</math> setting used for the associated channel is always the nominal value (approximately 60 ms). If 2xFBn bit is asserted, then <math>t_{LIM}</math> for associated channel is programmable as defined in the Timing Configuration register (0x16).</li> <li>3) If the assigned class for a channel is class 4 or above, the 2xFB bit will be automatically set during turn on.</li> </ol> <p>For a single signature 4-pair powered PD both bits will be set</p> <p>For a dual signature 4-pair powered PD each Channel will be set according to the individually assigned PD classification</p>
3-0	MPOL4 - MPOL1	R/W	0	<p>Manual Policing and Foldback configuration bits</p> <p>0 = The internal device firmware automatically adjusts the Policing (<math>P_{CUT}</math>) and 2xFBn settings based on the assigned class during port turn on</p> <p>1 = The Policing (<math>P_{CUT}</math>) and 2xFBn settings will not be changed during port turn on.</p> <p>Note: Independent of these settings, the Policing (<math>P_{CUT}</math>) and 2xFBn settings are returned to their default values upon port turn off.</p> <p>Note: Setting either bit for a 4P configured port disables the automatic configuration on <b>both</b> channels</p> <p>The MPOLn bits are cleared upon port turn off.</p>

**NOTE**

For 4-pair wired Ports the 2xFBn bits **individually** control each Channels operation.

Refer to register 0x55h description for more information on additional Foldback and Inrush configuration options





**9.6.2.49 FIRMWARE REVISION Register**

COMMAND = 41h with 1 Data Byte, Read Only

**Figure 95. FIRMWARE REVISION Register Format**

7	6	5	4	3	2	1	0
FRV							

LEGEND: R/W = Read/Write; R = Read only; -n = value after reset

**Table 54. FIRMWARE REVISION Register Field Descriptions**

Bit	Field	Type	Reset	Description
7–0	FRV	R		Firmware Revision number

After a RESET or POR fault this value will default to 0000, 0000b, but upon a “valid” SRAM load, this value will reflect the corresponding SRAM version of firmware (0x01h – 0xFEh).

---

**NOTE**

If the value of this register = 0xFFh, the device is running in “safe mode”, and the SRAM needs to be reprogrammed to resume normal operation.

---

### 9.6.2.50 I<sup>2</sup>C WATCHDOG Register

COMMAND = 42h with 1 Data Byte, Read/Write

The I<sup>2</sup>C watchdog timer monitors the I<sup>2</sup>C clock line in order to prevent hung software situations that could leave ports in a hazardous state. The timer can be reset by either edge on SCL input. If the watchdog timer expires, all channels will be turned off and WDS bit will be set. The nominal watchdog time-out period is 2 seconds.

**Figure 96. I<sup>2</sup>C WATCHDOG Register Format**

7	6	5	4	3	2	1	0
–	–	–	IWDD3	IWDD2	IWDD1	IWDD0	WDS
–	–	–	R/W-1	R/W-0	R/W-1	R/W-1	R/W-0

LEGEND: R/W = Read/Write; R = Read only; -n = value after reset

**Table 55. I<sup>2</sup>C WATCHDOG Register Field Descriptions**

Bit	Field	Type	Reset	Description
4–1	IWDD3–IWDD0	R/W	1011b	I <sup>2</sup> C Watchdog disable. When equal to 1011b, the watchdog is masked. Otherwise, it is unmasked and the watchdog is operational.
0	WDS	R/W	0	I <sup>2</sup> C Watchdog timer status, valid even if the watchdog is masked. When set, it means that the watchdog timer has expired without any activity on I <sup>2</sup> C clock line. Writing 0 at WDS location clears it. Note that when the watchdog timer expires and if the watchdog is unmasked, all channels are also turned off.

When the channels are turned OFF due to I<sup>2</sup>C watchdog, the corresponding bits are also cleared:

**Table 56. I<sup>2</sup>C WATCHDOG Reset**

Register	Bits to be Reset
0x04	CLSCn and DETCn
0x06	DISFn and PCUTn
0x08	STRn and ILIMn
0x0A/B	PCUTnn
0x0C-0F	Requested Class and Detection
0x10	PGn and PEn
0x14	CLEn and DETEn
0x1C	ACn and CCnn
0x1E-21	2P Policing set to 0xFFh
0x24	PFn
0x2A-2B	4P Policing set to 0xFFh
0x2D	NLMnn, NCTnn, 4PPCTnn, and DCDTnn
0x30-3F	Channel Voltage and Current Measurements
0x40	2xFBn
0x44 - 47	Detection Resistance Measurements
0x4C-4F	Assigned Class and Previous Class
0x51-54	Autoclass Measurement

The corresponding PGCn and PECn bits of Power Event register will also be set if there is a change. The corresponding PEn and PGn bits of Power Status Register are also updated accordingly.

**NOTE**

If the I<sup>2</sup>C watchdog timer has expired, the Temperature and Input voltage registers will stop being updated until the WDS bit is cleared. The WDS bit must then be cleared to allow these registers to work normally.

**9.6.2.51 DEVICE ID Register**

COMMAND = 43h with 1 Data Byte, Read Only

**Figure 97. DEVICE ID Register Format**

7	6	5	4	3	2	1	0
DID				SR			

LEGEND: R/W = Read/Write; R = Read only; -n = value after reset

**Table 57. DEVICE ID Register Field Descriptions**

Bit	Field	Type	Reset	Description
7–5	DID	R	0010b	Device ID number
4–0	SR	R	0010b	Silicon Revision number

**9.6.2.52 CHANNEL 1 DETECT RESISTANCE Register**

COMMAND = 44h with 1 Data Byte, Read Only

**Figure 98. CHANNEL 1 DETECT RESISTANCE Register Format**

7	6	5	4	3	2	1	0
R1_7	R1_6	R1_5	R1_4	R1_3	R1_2	R1_1	R1_0
R-0	R-0	R-0	R-0	R-0	R-0	R-0	R-0

LEGEND: R/W = Read/Write; R = Read only; -n = value after reset

**9.6.2.53 CHANNEL 2 DETECT RESISTANCE Register**

COMMAND = 45h with 1 Data Byte, Read Only

**Figure 99. CHANNEL 2 DETECT RESISTANCE Register Format**

7	6	5	4	3	2	1	0
R2_7	R2_6	R2_5	R2_4	R2_3	R2_2	R2_1	R2_0
R-0	R-0	R-0	R-0	R-0	R-0	R-0	R-0

LEGEND: R/W = Read/Write; R = Read only; -n = value after reset

**9.6.2.54 CHANNEL 3 DETECT RESISTANCE Register**

COMMAND = 46h with 1 Data Byte, Read Only

**Figure 100. CHANNEL 3 DETECT RESISTANCE Register Format**

7	6	5	4	3	2	1	0
R3_7	R3_6	R3_5	R3_4	R3_3	R3_2	R3_1	R3_0
R-0	R-0	R-0	R-0	R-0	R-0	R-0	R-0

LEGEND: R/W = Read/Write; R = Read only; -n = value after reset

**9.6.2.55 CHANNEL 4 DETECT RESISTANCE Register**

COMMAND = 47h with 1 Data Byte, Read Only

**Figure 101. CHANNEL 4 DETECT RESISTANCE Register Format**

7	6	5	4	3	2	1	0
R4_7	R4_6	R4_5	R4_4	R4_3	R4_2	R4_1	R4_0
R-0	R-0	R-0	R-0	R-0	R-0	R-0	R-0

LEGEND: R/W = Read/Write; R = Read only; -n = value after reset

**Table 58. DETECT RESISTANCE Register Fields Descriptions**

Bit	Field	Type	Reset	Description				
7-0	Rn_7- Rn_0	R	0	8-bit data conversion result of detection resistance for channel n. Most recent 2-point Detection Resistance measurement result. The I <sup>2</sup> C data transmission is a 1-byte transfer. Note that the register content is not cleared at turn off. The equation defining the resistance measured is: $R = N \times R_{STEP}$ Where R <sub>STEP</sub> is defined below as well as the full scale value: <table border="1" data-bbox="597 1686 1117 1759"> <thead> <tr> <th>Useable Resistance Range</th> <th>R<sub>STEP</sub></th> </tr> </thead> <tbody> <tr> <td>2 kΩ to 50 kΩ</td> <td>195.3125 Ω</td> </tr> </tbody> </table>	Useable Resistance Range	R <sub>STEP</sub>	2 kΩ to 50 kΩ	195.3125 Ω
Useable Resistance Range	R <sub>STEP</sub>							
2 kΩ to 50 kΩ	195.3125 Ω							

**9.6.2.56 CHANNEL 1 DETECT CAPACITANCE Register**

COMMAND = 48h with 1 Data Byte, Read Only

**Figure 102. CHANNEL 1 DETECT CAPACITANCE Register Format**

7	6	5	4	3	2	1	0
C1_7	C1_6	C1_5	C1_4	C1_3	C1_2	C1_1	C1_0
R-0	R-0	R-0	R-0	R-0	R-0	R-0	R-0

LEGEND: R/W = Read/Write; R = Read only; -n = value after reset

**9.6.2.57 CHANNEL 2 DETECT CAPACITANCE Register**

COMMAND = 49h with 1 Data Byte, Read Only

**Figure 103. CHANNEL 2 DETECT CAPACITANCE Register Format**

7	6	5	4	3	2	1	0
C2_7	C2_6	C2_5	C2_4	C2_3	C2_2	C2_1	C2_0
R-0	R-0	R-0	R-0	R-0	R-0	R-0	R-0

LEGEND: R/W = Read/Write; R = Read only; -n = value after reset

**9.6.2.58 CHANNEL 3 DETECT CAPACITANCE Register**

COMMAND = 4Ah with 1 Data Byte, Read Only

**Figure 104. CHANNEL 3 DETECT CAPACITANCE Register Format**

7	6	5	4	3	2	1	0
C3_7	C3_6	C3_5	C3_4	C3_3	C3_2	C3_1	C3_0
R-0	R-0	R-0	R-0	R-0	R-0	R-0	R-0

LEGEND: R/W = Read/Write; R = Read only; -n = value after reset

**9.6.2.59 CHANNEL 4 DETECT CAPACITANCE Register**

COMMAND = 4Bh with 1 Data Byte, Read Only

**Figure 105. CHANNEL 4 DETECT CAPACITANCE Register Format**

7	6	5	4	3	2	1	0
C4_7	C4_6	C4_5	C4_4	C4_3	R4_2C	C4_1	C4_0
R-0	R-0	R-0	R-0	R-0	R-0	R-0	R-0

LEGEND: R/W = Read/Write; R = Read only; -n = value after reset

**Table 59. DETECT CAPACITANCE Register Fields Descriptions**

Bit	Field	Type	Reset	Description				
7-0	Cn_7- Cn_0	R	0	<p>8-bit data conversion result of capacitance measurement for channel n. Most recent capacitance measurement result. The I<sup>2</sup>C data transmission is a 1-byte transfer. The equation defining the resistance measured is:</p> $C = N \times C_{STEP}$ <p>Where C<sub>STEP</sub> is defined below as well as the full scale value:</p> <table border="1" style="margin-left: 40px;"> <tr> <th>Useable Resistance Range</th> <th>C<sub>STEP</sub></th> </tr> <tr> <td>1 μF to 12 μF</td> <td>0.05 μF</td> </tr> </table> <p>Note that the register content is not cleared at turn off.            Note: The capacitance measurement is only supported in Manual/Diagnostic mode.            Note: No capacitance measurement will be made if the result of the resistance detection is returned as "valid".            Note: The TPS23881 SRAM needs to be programmed in order for the capacitance measurement to operate properly.</p>	Useable Resistance Range	C <sub>STEP</sub>	1 μF to 12 μF	0.05 μF
Useable Resistance Range	C <sub>STEP</sub>							
1 μF to 12 μF	0.05 μF							

**9.6.2.60 CHANNEL 1 ASSIGNED CLASS Register**

COMMAND = 4Ch with 1 Data Byte, Read Only

**Figure 106. CHANNEL 1 ASSIGNED CLASS Register Format**

7	6	5	4	3	2	1	0
AClass Ch1				PClass Ch1			
R-0	R-0	R-0	R-0	R-0	R-0	R-0	R-0

LEGEND: R/W = Read/Write; R = Read only; -n = value after reset

**9.6.2.61 CHANNEL 2 ASSIGNED CLASS Register**

COMMAND = 4Dh with 1 Data Byte, Read Only

**Figure 107. CHANNEL 2 ASSIGNED CLASS Register Format**

7	6	5	4	3	2	1	0
AClass Ch2				PClass Ch2			
R-0	R-0	R-0	R-0	R-0	R-0	R-0	R-0

LEGEND: R/W = Read/Write; R = Read only; -n = value after reset

**9.6.2.62 CHANNEL 3 ASSIGNED CLASS Register**

COMMAND = 4Eh with 1 Data Byte, Read Only

**Figure 108. CHANNEL 3 ASSIGNED CLASS Register Format**

7	6	5	4	3	2	1	0
AClass Ch3				PClass Ch3			
R-0	R-0	R-0	R-0	R-0	R-0	R-0	R-0

LEGEND: R/W = Read/Write; R = Read only; -n = value after reset

**9.6.2.63 CHANNEL 4 ASSIGNED CLASS Register**

COMMAND = 4Fh with 1 Data Byte, Read Only

**Figure 109. CHANNEL 4 ASSIGNED CLASS Register Format**

7	6	5	4	3	2	1	0
AClass Ch4				PClass Ch4			
R-0	R-0	R-0	R-0	R-0	R-0	R-0	R-0

LEGEND: R/W = Read/Write; R = Read only; -n = value after reset

**Bit Descriptions:** These bits represent the "assigned" and previous classification results for channel n. These bits are cleared when channel n is turned off.

**Table 60. CHANNEL n ASSIGNED CLASS Register Field Descriptions**

Bit	Field	Type	Reset	Description
7–4	ACLASS Ch-n	R	0	Assigned classification on channel n. See <a href="#">Table 61</a> below
3–0	PCLASS Ch-n	R	0	Previous Class result on channel n. See <a href="#">Table 62</a> below

**Table 61. Assigned Class Designations**

ACLASS-Chn				Assigned Class
Bit 7	Bit 6	Bit 5	Bit 4	
0	0	0	0	Unknown
0	0	0	1	Class 1
0	0	1	0	Class 2
0	0	1	1	Class 3
0	1	0	0	Class 4
0	1	0	1	Reserved
0	1	1	0	Reserved
0	1	1	1	Reserved
1	0	0	0	Class 5 - 4-Pair Single Signature
1	0	0	1	Class 6 - 4-Pair Single Signature
1	0	1	0	Class 7 - 4-Pair Single Signature
1	0	1	1	Class 8 - 4-Pair Single Signature
1	1	0	0	Reserved
1	1	0	1	Class 5 - 4-Pair Dual Signature
1	1	1	0	Reserved
1	1	1	1	Reserved

**Table 62. Previous Class Designations**

PCLASS-Chn				Previous Class
Bit 7	Bit 6	Bit 5	Bit 4	
0	0	0	0	Unknown
0	0	0	1	Class 1
0	0	1	0	Class 2
0	0	1	1	Class 3
0	1	0	0	Class 4
0	1	0	1	Reserved
0	1	1	0	Class 0
0	1	1	1	Reserved
1	0	0	0	Class 5 - 4-Pair Single Signature
1	0	0	1	Class 6 - 4-Pair Single Signature
1	0	1	0	Class 7 - 4-Pair Single Signature
1	0	1	1	Class 8 - 4-Pair Single Signature
1	1	0	0	Reserved
1	1	0	1	Class 5 - 4-Pair Dual Signature
1	1	1	0	Reserved
1	1	1	1	Reserved

**“Requested” vs. “Assigned” Classification:**

The “requested” class is the classification the PSE measures during Mutual Identification prior to turn on, whereas the “assigned” class is the classification level the Channel was powered on with based on the Power Allocation setting in register 0x29h. The “requested” classification values are available in registers 0x0C-0F

For a 4-pair single signature device, both channels will report the same assigned PD classification within 5ms after classification is completed. However, only the channel that classification was measured on will have the CLSCn bit set in register 0x04h

For a 4-pair dual signature device each Channel will reports is own individually assigned PD classification within 5ms of turn on.

---

**NOTE**

Upon being powered, devices that present a class 0 signature during discovery will be given an assigned class of "Class 3"

---

---

**NOTE**

There is no Assigned Class assigned for ports/channels powered out of Manual/Diagnostic mode. Any settings such as the port power policing and 1x/2x foldback selection that are typically configure based on the assigned class result need to manually configured by the user.

---

**Previous Classification**

In certain circumstances the requested class result in 0x0C-0F can not properly reflect the actual classification of the PD connected to the port/channel. This will happen when a port has a power allocation limit of 15.4W and the PSE can only provide 1 classification finger during turn on. When this occurs and if the device is configured to run in Semi Auto mode with det and cls enabled, the 3-finger classification measurement that preceded the turn on detection and classification cycle will be stored here. This information can be useful in scenarios where a port had to be demoted to stay under the system power limit at turn on but additional power budget comes available later on.

---

**NOTE**

The Previous Classification results are only valid for channels being used in semi auto mode with ongoing discovery (DETE and CLE = 1).

---



### 9.6.2.64 AUTO CLASS CONTROL Register

COMMAND = 50h with 1 Data Byte, Read/Write

**Figure 110. AUTO CLASS CONTROL Register Format**

7	6	5	4	3	2	1	0
MAC4	MAC3	MAC2	MAC1	AAC4	AAC3	AAC2	AAC1
R/W-0	R/W-0	R/W-0	R/W-0	R/W-0	R/W-0	R/W-0	R/W-0

LEGEND: R/W = Read/Write; R = Read only; -n = value after reset

**Table 63. AUTO CLASS CONTROL Register Field Descriptions**

Bit	Field	Type	Reset	Description
7 - 4	MACn	R/W	0	Manual Auto Class Measurement bits 1 = Manual Auto Class Measurement enabled 0 = Manual Auto Class measurement complete The auto class measurement will begin within 10ms of this bit being set. This bit will be cleared by the internal firmware within 1ms of the updated Autoclass measurement result(s) in 0x51-54h.
3 - 0	AACn	R/W	0	Auto Class Auto Adjustment Enable bits 1 = Autoclass auto adjust is enabled and the corresponding PCUT settings will be automatically adjusted based on the measured autoclass power 0 = Autoclass auto adjust is disabled and it is up to the user to adjust the value of PCUT as desired.

**NOTE**

Any MACn bits set prior to turn on will be ignored and cleared during turn on.

**Auto Class Pcut Adjustments:**

If the ACx bit(s) are set in register 0x50h, the TPS23881 will automatically adjust its PCUT value based on the auto class power measurement ( $P_{AC}$  in registers 0x51-54) and Any Automatic Auto Class facilitated (AACn = 1) PCut adjustments will be made within 5 ms of the end of the auto class measurement period.

If the AACn bits are not set, the table and equations below should be used to make any PCUT adjustments based on the auto class power measurement ( $P_{AC}$ ).

**Table 64. Typical Auto Class Margins by Measured Power**

Auto Class Measured Power ( $P_{AC}$ )	$P_{AC\_MARGIN}$
$P_{AC} < 18.5\text{ W}$	0.5 W
$19\text{ W} < P_{AC} < 25.5\text{ W}$	1 W
$26\text{ W} < P_{AC} < 36.5\text{ W}$	2 W
$36.5\text{ W} < P_{AC} < 45\text{ W}$	3 W
$45\text{ W} < P_{AC} < 51.5\text{ W}$	4 W
$51.5\text{ W} < P_{AC} < 58\text{ W}$	5 W
$58\text{ W} < P_{AC} < 63\text{ W}$	6 W
$63\text{ W} < P_{AC} < 68\text{ W}$	7W
$68\text{ W} < P_{AC} < 73\text{ W}$	8W
$P_{AC} > 73\text{ W}$	9W

---

**NOTE**

For a PSE supporting Auto Class, the  $P_{AC\_MARGIN}$  is an IEEE required surplus of power over the measured power during auto class that allows for component degradation over time.

---

For 2-Pair or Dual Signature 4-Pair PDs, only the 2P-PCut values will be updated based on each pair sets measured PAC according to the equation below.

$$2P\text{-PCut} = P_{AC} + P_{AC\_MARGIN}$$

For Single signature 4-Pair PDs, the sum of the autoclass power measurements on each pair set will be used to determine the 4P-PCut setting according to the equation below:

$$4P\text{-PCut} = P_{AC\_ALTA} + P_{AC\_ALTB} + P_{AC\_MARGIN}$$

For Single signature 4-Pair PDs, the auto class measurements will have no impact on the 2P-PCut settings. These values will remain unchanged from the 2P-Pcut settings prior to the start of the auto class measurement.

---

**NOTE**

For 4-pair wired ports with single signature connected devices:

if only one AACn bit is set and an autoclass power measurement is completed (manual or during turn on), the 4-PCut value will still be updated based on the power measurement

If only one MACn bit is set, no autoclass measurement will be completed.

---

**NOTE**

If the result of  $P_{AC} + P_{AC\_MARGIN}$  is **above** a Channel's assigned classification range, no changes will be made to the either the 2P or 4P Pcut settings.

---

### 9.6.2.65 CHANNEL 1 AUTO CLASS POWER Register

COMMAND = 51h with 1 Data Byte, Read Only

**Figure 111. CHANNEL 1 AUTO CLASS POWER Register Format**

7	6	5	4	3	2	1	0
-	PAC1_6	PAC1_5	PAC1_4	PAC1_3	PAC1_2	PAC1_1	PAC1_0
R-0	R-0	R-0	R-0	R-0	R-0	R-0	R-0

LEGEND: R/W = Read/Write; R = Read only; -n = value after reset

### 9.6.2.66 CHANNEL 2 AUTO CLASS POWER Register

COMMAND = 52h with 1 Data Byte, Read Only

**Figure 112. CHANNEL 2 AUTO CLASS POWER Register Format**

7	6	5	4	3	2	1	0
-	PAC2_6	PAC2_5	PAC2_4	PAC2_3	PAC2_2	PAC2_1	PAC2_0
R-0	R-0	R-0	R-0	R-0	R-0	R-0	R-0

LEGEND: R/W = Read/Write; R = Read only; -n = value after reset

### 9.6.2.67 CHANNEL 3 AUTO CLASS POWER Register

COMMAND = 53h with 1 Data Byte, Read Only

**Figure 113. CHANNEL 3 AUTO CLASS POWER Register Format**

7	6	5	4	3	2	1	0
-	PAC3_6	PAC3_5	PAC3_4	PAC3_3	PAC3_2	PAC3_1	PAC3_0
R-0	R-0	R-0	R-0	R-0	R-0	R-0	R-0

LEGEND: R/W = Read/Write; R = Read only; -n = value after reset

### 9.6.2.68 CHANNEL 4 AUTO CLASS POWER Register

COMMAND = 54h with 1 Data Byte, Read Only

**Figure 114. CHANNEL 4 AUTO CLASS POWER Register Format**

7	6	5	4	3	2	1	0
-	PAC4_6	PAC4_5	PAC4_4	PAC4_3	PAC4_2	PAC4_1	PAC4_0
R-0	R-0	R-0	R-0	R-0	R-0	R-0	R-0

LEGEND: R/W = Read/Write; R = Read only; -n = value after reset

**Table 65. AUTO CLASS POWER Register Fields Descriptions**

Bit	Field	Type	Reset	Description
6-0	PACn_6- PACn_0	R	0	8-bit data conversion result of the auto class power measurement for channel n. Peak average power calculation result from channel voltage and current data conversion measurements taken during the auto class power measurement window. The equation defining the auto class power measured is: $P_{AC} = N \times P_{AC\_STEP}$ Where, when assuming 0.200-Ω Rsense resistor is used: $P_{C\_STEP} = 0.5 W$

#### NOTE

The IEEE requires a surplus of power (defined as  $P_{AC\_MARGIN}$ ) to be available over the measured auto class power to allow for component degradation over time. See [Table 64](#) for the relationship between  $P_{AC}$  and  $P_{AC\_MARGIN}$

9.6.2.69 ALTERNATIVE FOLDBACK Register

COMMAND = 55h with 1 Data Byte, Read/Write

Figure 115. ALTERNATIVE FOLDBACK Register Format

7	6	5	4	3	2	1	0
ALTFB4	ALTFB3	ALTFB2	ALTFB1	ALTIR4	ALTIR3	ALTIR2	ALTIR1
R/W-0	R/W-0	R/W-0	R/W-0	R/W-0	R/W-0	R/W-0	R/W-0

LEGEND: R/W = Read/Write; R = Read only; -n = value after reset

Table 66. ALTERNATIVE FOLDBACK Register Field Descriptions

Bit	Field	Type	Reset	Description
7-4	ALTFBn	R	0	Alternative Foldback Enable bits: Used to enable the operational alternative foldback curves while powered. 1 = Alternative Foldback is enabled 0 = Alternative Foldback is disabled The ALTFBn bits should be set prior to issuing a PWONn command to ensure the desired foldback curve is being used.
3-0	ALTIRn	R	0	Alternative Inrush Enable bits: Used to enable the alternative foldback curves during inrush on channel n 1 = Alternative Inrush is enabled 0 = Alternative Inrush is disabled Note: The ALTIRn bits need to be set prior to sending a PWONn command to ensure the desired inrush behavior is followed

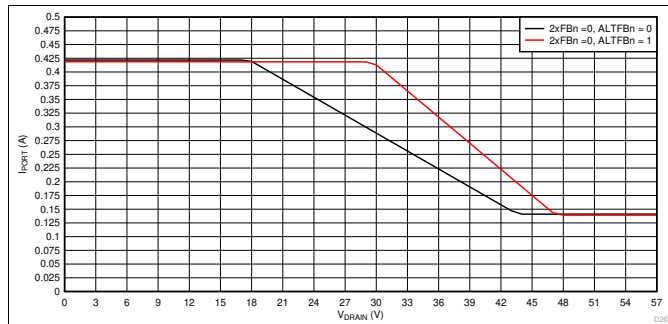


Figure 116. 1x Mode (2xFBn = 0) Foldback Curves, I<sub>PORT</sub> vs V<sub>DRAIN</sub>

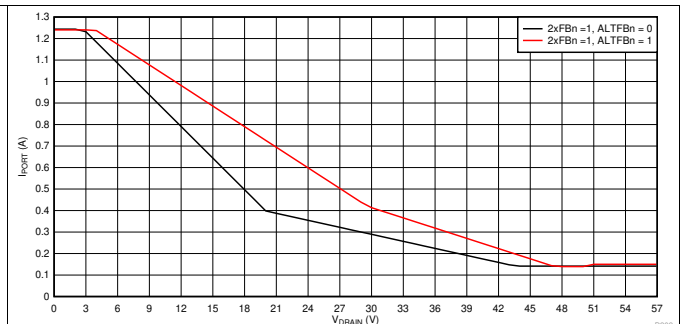


Figure 117. 2x Mode (2xFBn = 1) Foldback Curves, I<sub>PORT</sub> vs V<sub>DRAIN</sub>

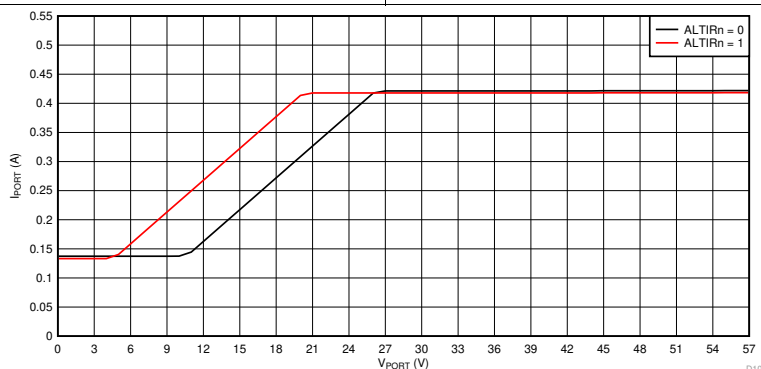


Figure 118. Inrush Foldback Curves, I<sub>PORT</sub> vs V<sub>PORT</sub>

### 9.6.2.70 SRAM CONTROL Register

COMMAND = 60h with 1 Data Byte, Read/Write

**Figure 119. SRAM CONTROL Register Format**

7	6	5	4	3	2	1	0
PROG_SEL	CPU_RST	-	PAR_EN	RAM_EN	PAR_SEL	R/WZ	CLR_PTR
R/W-0	R/W-0	R/W-0	R/W-0	R/W-0	R/W-0	R/W-0	R/W-0

LEGEND: R/W = Read/Write; R = Read only; -n = value after reset

**Table 67. SRAM CONTROL Register Field Descriptions**

Bit	Field	Type	Reset	Description
7	PROG_SEL	R/W	0	I2C Programming select bit. 1 = SRAM I2C read/write is enabled 0 = SRAM I2C read/write is disabled.
6	CPU_RST	R/W	0	CPU Reset bit 1 = Internal CPU is held in RESET 0 = Internal CPU is active This is strictly a CPU reset. Toggling this bit reset the cpu only and will not change any contents of the I <sup>2</sup> C registers
5	Reserved	R/W	0	Reserved
4	PAR_EN	R/W	0	SRAM Parity Enable bit: 1 = SRAM Parity Check will be enabled 0 = SRAM Parity Check will be disabled It is recommended that the Parity function be enable whenever SRAM is being used
3	RAM_EN	R/W	0	SRAM Enable bit 1 = SRAM will be enabled and the internal CPU will run from both SRAM and internal ROM 0 = Internal CPU will run from internal ROM only This bit needs to be set to a 1 after SRAM programing to enable the utilization of the SRAM code
2	PAR_SEL	R/W	0	SRAM Parity Select bit: Setting this bit to a 1 in conjunction with the RZ/W bit enables access to the SRAM Parity bits. 1 = Parity bits read/write is enabled 0 = Parity bits read/write is disabled
1	R/WZ	R/W	0	SRAM Read/Write select bit: 0 = SRAM Write – SRAM data is written with a write to 0x61h 1 = SRAM Read – SRAM data is read with a read from 0x61h SRAM data can be continuously read/written over I2C until a STOP bit is sent.
0	CLR_PTR	R/W	0	Clear Address Pointer bit: 1 = Resets the memory address pointer 0 = Releases pointer for use In order to ensure proper programming, this bit should be toggled (0-1-0) to writing or reading the SRAM or Parity memory.

**SRAM Programming:**

Upon power up, it is recommended that the TPS23881's SRAM be programmed to the latest version of code available for download through the [TI mySecure Software](#) webpage.. All I<sup>2</sup>C traffic other than those commands outlined below to program the SRAM shall be deferred until after the SRAM programming sequences below are complete.

---

**NOTE**

For TPS23881 applications choosing not to load SRAM and run from the internal ROM only, please consult the SRAM Release notes and ROM Advisory documentation available through the [TI mySecure Software](#) webpage.

---



---

**NOTE**

The SRAM programming control must be completed at the lower I2C address (Channels 1-4). Configuring this registers for the upper I2C device address (Channels 5-8) will not program the SRAM

---



---

**NOTE**

The SRAM programming needs to be delayed at least 50ms from the initial power on (VPWR and VDD above UVLO) of the device to allow for the device to complete its internal hardware initialization process

---

**0x60h setup for SRAM Programming:** Prior to programming/writing the SRAM, the following bits sequence needs to be completed in register 0x60h:

7	6	5	4	3	2	1	0
PROG_SEL	CPU_RST	-	PAR_EN	RAM_EN	PAR_SEL	R/WZ	CLR_PTR
0 → 1	0 → 1	0	0	0	0	1 → 0	0 → 1 → 0

The same sequence is required to read the SRAM with the exception that the R/WZ bit needs to be set to “1”.

If the device is in “Safe Mode”, the same sequence as above may be used to reprogram the SRAM.

An I<sup>2</sup>C write to 0x61h following this sequence actively programs the SRAM program memory starting from the address set in registers 0x62h and 63h.

**0x60h setup for SRAM Parity Programming:** Following the programming of the SRAM program memory, the following bits sequence needs to be completed in register 0x60h in order to configure the device to program the Parity memory:

7	6	5	4	3	2	1	0
PROG_SEL	CPU_RST	-	PAR_EN	RAM_EN	PAR_SEL	R/WZ	CLR_PTR
0 → 1	0 → 1	0	0	0	0 → 1	1 → 0	0 → 1 → 0

The same sequence is required to read the Parity with the exception that the R/WZ bit needs to be set to “1”.

An I<sup>2</sup>C write to 0x61h following this sequence actively programs the Parity memory starting from the address set in registers 0x62h and 63h.

**0x60h setup to run from SRAM Program Memory:** Upon completion of programming, the following bits sequence needs to be completed in register 0x60h in order to enable the device to run properly out of SRAM:

7	6	5	4	3	2	1	0
PROG_SEL	CPU_RST	-	PAR_EN	RAM_EN	PAR_SEL	R/WZ	CLR_PTR
1 → 0	1 → 0	0	0 → 1	0 → 1	1 → 0	0	0

Within 1ms of the completion of the above sequence, the device will complete a compatibility check on the SRAM

If the SRAM load is determined to be “Valid”: Register 0x41h will have a value between 0x01h and 0xFEh, and the device will return to normal operation.

If the SRAM load is determined to be “Invalid”:

- 0x41h will be set to 0xFFh
- The RAM\_EN bit will be internally cleared
- The device will operating in “safe mode” until another programming attempt is completed

#### 9.6.2.71 SRAM START ADDRESS (LSB) Register

COMMAND = 62h with 1 Byte, Read/Write

**Figure 120. SRAM START ADDRESS (LSB) Register Format**

7	6	5	4	3	2	1	0
SA_7	SA_6	SA_5	SA_4	SA_3	SA_2	SA_1	SA_0
R/W-0	R/W-0	R/W-0	R/W-0	R/W-0	R/W-0	R/W-0	R/W-0

LEGEND: R/W = Read/Write; R = Read only; -n = value after reset

#### 9.6.2.72 SRAM START ADDRESS (MSB) Register

COMMAND = 63h with 1 Byte, Read/Write

**Figure 121. SRAM START ADDRESS (MSB) Register Format**

7	6	5	4	3	2	1	0
SA_15	SA_14	SA_13	SA_12	SA_11	SA_10	SA_9	SA_8
R/W-0	R/W-0	R/W-0	R/W-0	R/W-0	R/W-0	R/W-0	R/W-0

LEGEND: R/W = Read/Write; R = Read only; -n = value after reset

**Table 68. SRAM START ADDRESS Register Field Descriptions**

Bit	Field	Type	Reset	Description
15-0	SA_15- SA_0	R/W	0	SRAM and Parity Programming Start Address bits: the value entered into these registers sets the start address location for the SRAM or Parity programming

## 10 Application and Implementation

### NOTE

Information in the following applications sections is not part of the TI component specification, and TI does not warrant its accuracy or completeness. TI's customers are responsible for determining suitability of components for their purposes. Customers should validate and test their design implementation to confirm system functionality.

### 10.1 Application Information

The TPS23881 is an 8-channel, IEEE 802.3bt ready PoE PSE controller and can be used in high port count semiauto or fully micro-controller managed applications (The MSP430FR5969 micro-controller is recommended for most applications). Subsequent sections describe detailed design procedures for applications with different requirements including host control.

The schematic of [Figure 122](#) depicts semiauto mode operation of the TPS23881, providing functionality to power PoE loads. The TPS23881 can do the following:

1. Performs load detection.
2. Performs classification for type-1 (one finger) through type-4 (five finger) loads.
3. Enables power on with protective foldback current limiting, and Port power policing ( $P_{CUT}$ ) value.
4. Shuts down in the event of fault loads and shorts.
5. Performs Maintain Power Signature function to insure removal of power if load is disconnected.
6. Undervoltage lock out occurs if VPWR falls below  $V_{PUV\_F}$  (typical 26.5 V).

Following a power-off command, disconnect or shutdown due to a Start,  $P_{CUT}$  or  $I_{LIM}$  fault, the port powers down. Following port power off due to a disconnect, the TPS23881 will immediately restart the detection and classification cycles if the DETE and CLE bits are set in register 0x14. If the shutdown is due to a start,  $P_{CUT}$  or  $I_{LIM}$  fault, the TPS23881 enters into a cool-down period during which any Detect/Class Enable Command for that port will be delayed. At the end of cool down cycle, one or more detection/class cycles are automatically restarted if the class and/or detect enable bits are set. If a port is disabled using the power off command, the DETE and CLE bits will be cleared and these bits will need to be reset over I<sup>2</sup>C in order for detection and classification to resume.

#### 10.1.1 Autonomous Operation

Unlike Auto mode, which still requires a host to initialize the TPS23881 operation through a series of I<sup>2</sup>C commands, there is no host or I<sup>2</sup>C communication required when the TPS23881 is configured in Autonomous mode.

Connecting a resistor between the AUTO pin and GND based on the table below will enable autonomous mode and configure all of the ports to the same Power Allocation settings. In the event a PD is connected with a higher requested class than the autonomous mode configuration, the port will power demote the PD to the selected autonomous mode configuration power level. The port automatically performs detection and classification (if valid detection occurs) continuously on all ports. Port power is automatically turned on based on Power Allocation settings in register 0x29 if a valid classification is measured.

**Table 69. AUTO Pin Programming**

Auto Pin	Autonomous Mode Configuration
Open/Floating	Disabled
124 k $\Omega$	2-pair 15 W
62 k $\Omega$	2-pair 30 W
35.7 k $\Omega$	4-pair 30W
22.6 k $\Omega$	4-pair 45W
15.8 k $\Omega$	4-pair 60W
11 k $\Omega$	4-pair 75W
7.7 k $\Omega$	4-pair 90W



**NOTE**

A 10 nF capacitor is required in parallel with  $R_{\text{AUTO}}$  to ensure stability in the Autonomous mode selection.

### 10.1.2 Introduction to PoE

Power-over-Ethernet (PoE) is a means of distributing power to Ethernet devices over the Ethernet cable using either data or spare pairs. PoE eliminates the need for power supplies at the Ethernet device. Common applications of PoE are security cameras, IP Phones and wireless access points (WAP). The host or mid-span equipment that supplies power is the power source equipment (PSE). The load at the Ethernet connector is the powered device (PD). PoE protocol between PSE and PD controlling power to the load is specified by IEEE 802.3bt standard. Transformers are used at Ethernet host ports, mid-spans and hubs, to interface data to the cable. A DC voltage can be applied to the center tap of the transformer with no effect on the data signals. As in any power transmission line, a relatively high voltage (approximately 50 V) is used to keep currents low and minimize the effects of IR drops in the line to preserve power delivery to the load. Standard 2-Pair PoE delivers approximately 13 W to a type 1 PD, and 25.5 W to a type 2 PD, whereas standard 4-Pair PoE will be capable of delivering approximately 51 W to a type 3 PD and 71 W to a type 4 PD.

#### 10.1.2.1 2-Pair Versus 4-Pair Power and the New IEEE802.3bt Standard

The IEEE 802.3at-2009 standard previously expanded PoE power delivery from 15.4W (Commonly referred to as .af or Type-1 PoE) to 30 W (.at or Type-2 PoE) of sourced power from the PSE (Power Sourcing Equipment) over 2-pairs of ethernet wires (Commonly known as either the Alt-A or Alt-B pair sets). The IEEE 802.3bt standard further expands power delivery up to 90 W sourced from a PSE by allowing for power delivery over both the ALT-A and ALT-B pairsets in parallel. Two new PoE equipment "Types" have also been created as part of the new standard. Type 3 PSE equipment will be capable of sourcing up to 60 W of power over 4-pair or 30 W over 2-pair while supporting the new MPS requirements. Type 4 PSE equipment will be capable of sourcing up to 90 W of power over 4-pair. The TPS23881 has been designed to be fully configurable to support any of these configurations.

The Maintain Power Signature (or MPS) requirements have also been updated for the new standard. The previous version of the standard only required PSEs to maintain power on a port if the PD (Powered Device) current exceeded 10 mA for at least 60 ms every 300 ms to 400 ms. By decreasing these requirements to 6 ms every 320 ms to 400 ms, the minimum power requirement to maintain PoE power have been reduced by a factor of nearly 10.

### 10.1.3 SRAM Programming

Upon power up, the TPS23881 device can operate from its internal ROM memory or users have the option of programming the SRAM via I<sup>2</sup>C.

**NOTE**

The latest version of TPS23881 firmware may be accessed from the [TI mySecure Software](#) webpage.

All I<sup>2</sup>C traffic other than those commands outlined below to program the SRAM shall be deferred until after the SRAM programming sequences below are complete.

For systems that include multiple TPS23881 devices, the 0x7F "global" broadcast I2C address may be used to programmed all of the devices at the same time.

Refer to the [How to Load TPS2388x SRAM Code](#) document on TI.com for more detailed instructions on the SRAM programing procedure.

## 10.2 Typical Application

This typical application shows an eight (2-Pair) port, semiauto mode application using a MSP430 or similar micro-controller. Operation in any mode requires I<sup>2</sup>C host support. The TPS23881 provides useful telemetry in multi-port applications to aid in implementing port power management.

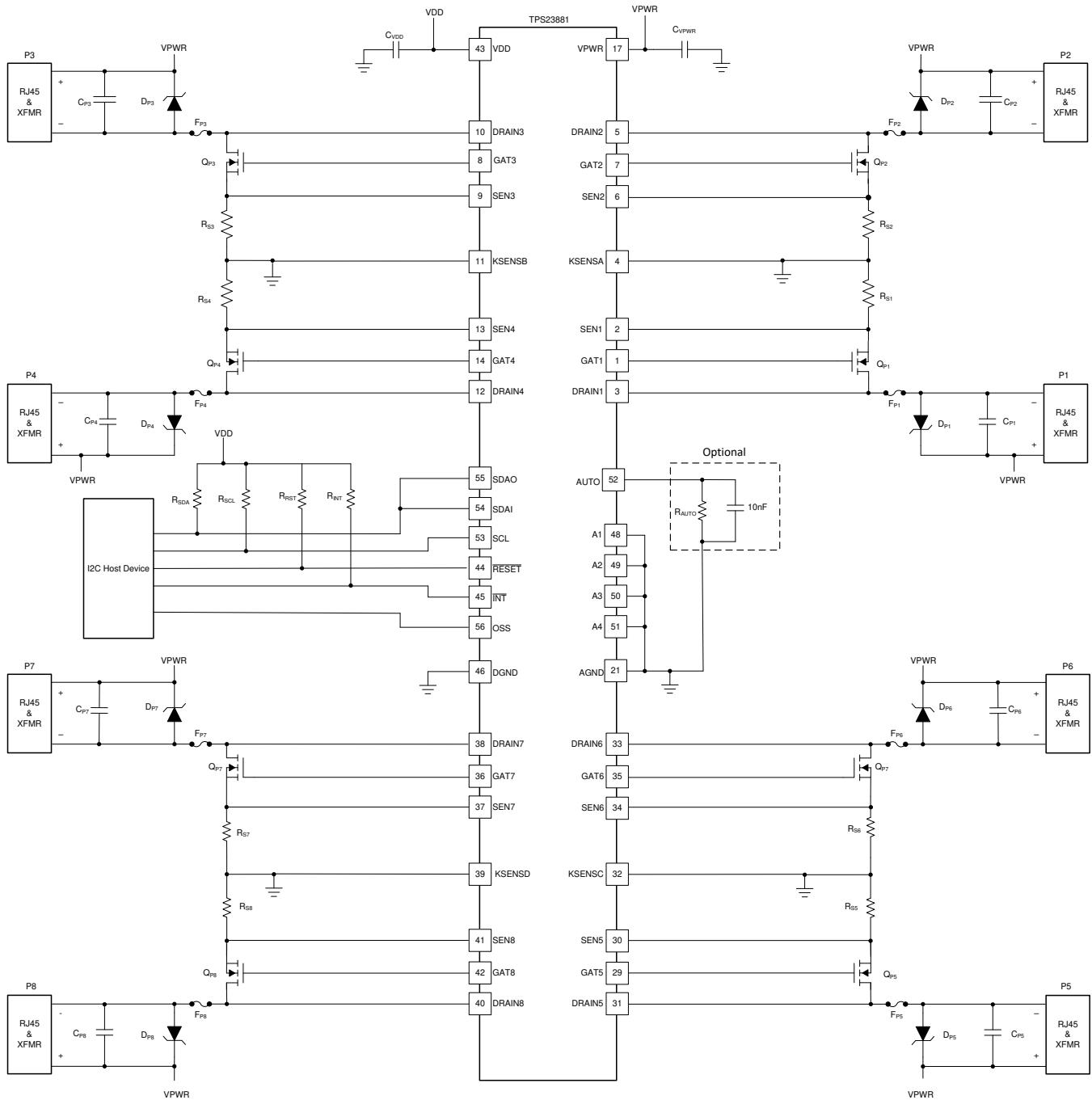


Figure 122. Eight 2-Pair Port Application

Typical Application (continued)

This typical application shows a four (4-Pair) port, semiauto mode application using a MSP430 or similar microcontroller.

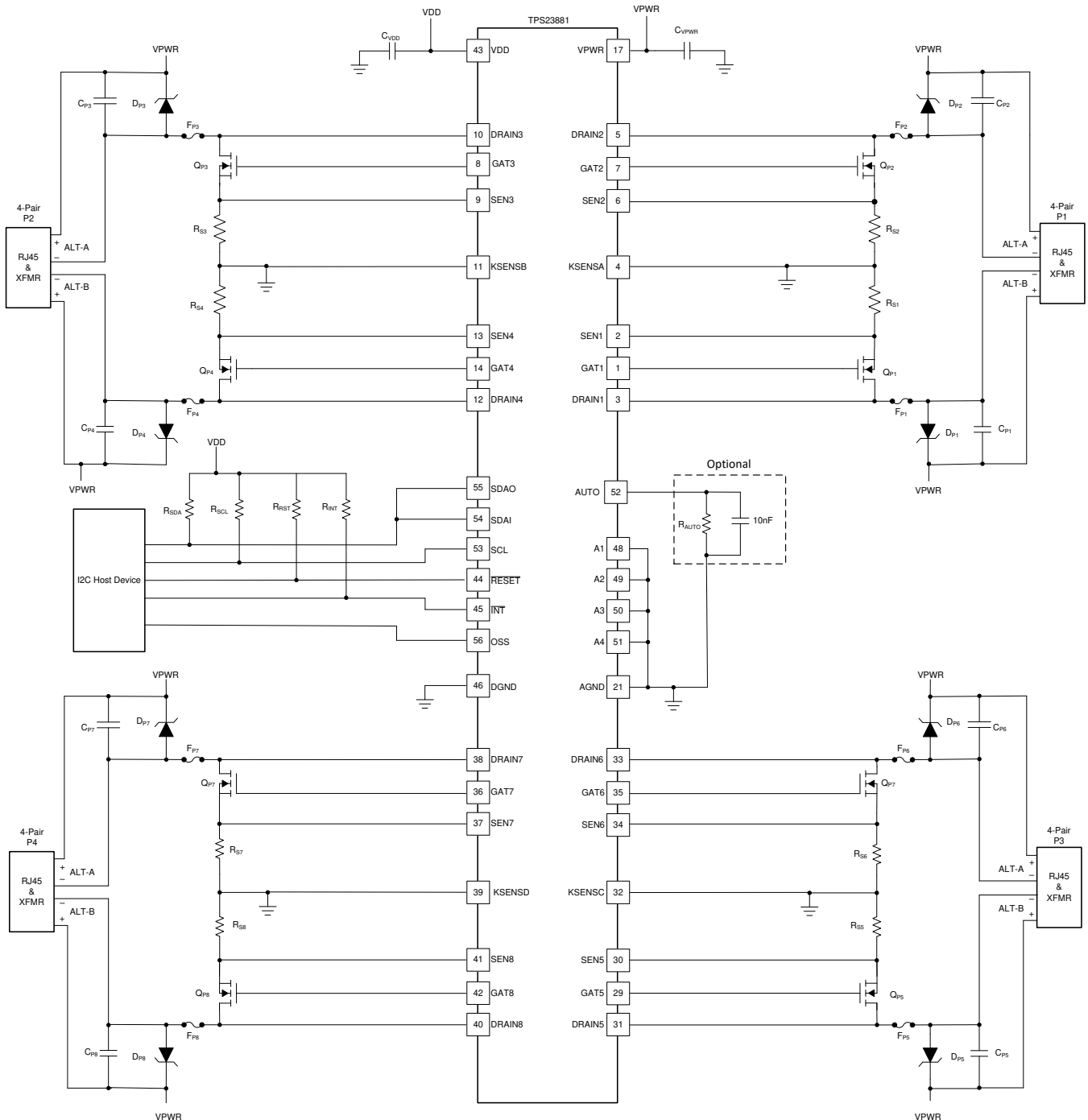


Figure 123. Four 4-Pair Port Application

## Typical Application (continued)

### 10.2.1 Design Requirements

TPS23881 devices are used in the eight port configuration and are managed by the I<sup>2</sup>C host device. The I<sup>2</sup>C address for TPS23881 is programmed using the A4..A1 pins. When using multiple TPS23881 devices in a system, each device requires by a unique I<sup>2</sup>C address. See [PIN STATUS Register](#) for more information on how to program the TPS23881 I<sup>2</sup>C address.

[Figure 122](#) and [Figure 123](#) show typical application for either all 2-pair or 4-pair ports, but the TPS23881 may also be configured to support any combination of either 2-pair or 4-pair PSE ports. 4-pair port requires the use of both Alternative A and Alternative B wire pair sets at the RJ45 terminal, whereas a 2-pair port only requires the Alternative A pair set to be used.

A MCU is not required to operate the TPS23881 device, but some type of I<sup>2</sup>C master/host controller device is required to program the internal SRAM and initialize the basic I<sup>2</sup>C register configuration of the TPS23881.

It is recommended that the  $\overline{\text{RESET}}$  pin be connected to a micro-controller or other external circuitry.

#### NOTE

The  $\overline{\text{RESET}}$  pin must be held low until both VPWR and VDD are above their UVLO thresholds.

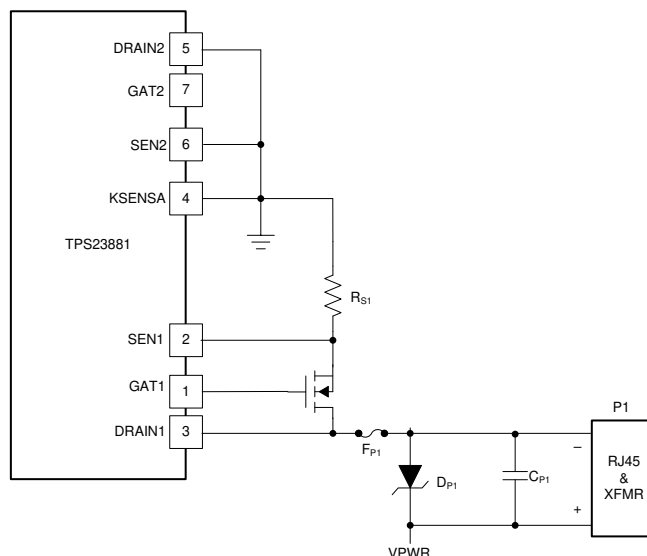
Refer to the [TPS23881EVM User's Guide](#) for more detailed information.

### 10.2.2 Detailed Design Procedure

Refer to the [TPS23881EVM User's Guide](#) for more detailed information on component selection and layout recommendations.

#### 10.2.2.1 Connections on Unused Channels

On unused channels, it is recommended to ground the SENx pin and leave the GATx pin open. DRAINx pins can be grounded or left open (leaving open may slightly reduce power consumption). [Figure 124](#) shows an example of an unused PORT2.



**Figure 124. Unused PORT2 Connections**

## Typical Application (continued)

### 10.2.2.2 Power Pin Bypass Capacitors

- $C_{VPWR}$ : 0.1  $\mu$ F, 100 V, X7R ceramic at pin 17 (VPWR)
- $C_{VDD}$ : 0.1  $\mu$ F, 5 V, X7R ceramic at pin 43 (VDD)
- $C_{AUTO}$  <sup>(1)</sup>: 10 nF, 5 V, X7R ceramic at pin 52 (AUTO) <sup>(1)</sup>

### 10.2.2.3 Per Port Components

- $C_{Pn}$ : 0.1- $\mu$ F, 100-V, X7R ceramic between VPWR and Pn-
- $R_{Sn}$ : Each channel's current sense resistor is a 0.2- $\Omega$ . A 1%, 0.25-W resistor in an 0805 SMT package is recommended. If a 90W Policing ( $P_{CUT}$ ) threshold is selected, the maximum power dissipation for the resistor becomes approximately 140 mW.

---

#### NOTE

For systems requiring either more accurate system power monitoring or precise Port Power Policing accuracy, it is recommend that 0.1%  $R_{SENSE}$  resistors be used.

---

- $Q_{Pn}$ : The port MOSFET can be a small, inexpensive device with average performance characteristics.  $BV_{DSS}$  should be 100 V minimum. Target a MOSFET  $R_{DS(on)}$  at  $V_{GS} = 10$  V of between 50 m $\Omega$  and 150 m $\Omega$ . The MOSFET GATE charge ( $Q_G$ ) and input capacitance ( $C_{ISS}$ ) should be less than 50 nC and 2000 pF respectively. The maximum power dissipation for  $Q_{Pn}$  with  $R_{DS(on)} = 100$  m $\Omega$  at 640 mA nominal policing ( $I_{CUT}$ ) threshold is approximately 45 mW.

---

#### NOTE

In addition to the MOSFET  $R_{DS(on)}$  and  $BV_{DSS}$  characteristics, the power MOSFET SOA ratings also need to be taken into consideration when selecting these components for your system design. It is recommended that a MOSFET be chosen with an SOA rating that exceeds the inrush and operational foldback characteristic curves as shown in [Figure 39](#) and [Figure 40](#). When using the standard current foldback (ALTIRn or ALTFBn = 0) options, the CSD19538Q3A 100V N-Channel MOSFET is recommended.

---

- $F_{Pn}$ : The port fuse should be a slow blow type rated for at least 60 VDC and above approximately 2 x  $P_{CUT}$  (max). The cold resistance should be below 200 m $\Omega$  to reduce the DC losses. The power dissipation for FPN with a cold resistance of 180 m $\Omega$  at maximum  $P_{CUT}$  is approximately 150 mW.
- $D_{PnA}$ : The port TVS should be rated for the expected port surge environment.  $D_{PnA}$  should have a minimum reverse standoff voltage of 58 V and a maximum clamping voltage of less than 95 V at the expected peak surge current

(1) Only required if  $R_{AUTO}$  is also connected to the AUTO pin

## Typical Application (continued)

### 10.2.2.4 System Level Components (not shown in the schematic diagrams)

The system TVS and bulk VPWR capacitance work together to protect the PSE system from surge events which could cause VPWR to surge above 70 V. The TVS and bulk capacitors should be placed on the PCB such that all TPS23881 ports are adequately protected.

- **TVS:** The system TVS should be rated for the expected peak surge power of the system and have a minimum reverse standoff voltage of 58 V. Together with the VPWR bulk capacitance, the TVS must prevent the VPWR rail from exceeding 70 V.
- **Bulk Capacitor:** The system bulk capacitor(s) should be rated for 100 V and can be of aluminum electrolytic type. Two 47- $\mu$ F capacitors can be used for each TPS23881 on board.
- **Distributed Capacitance:** In higher port count systems, it may be necessary to distribute 1- $\mu$ F, 100-V, X7R ceramic capacitors across the 54-V power bus. One capacitor per each TPS23881 pair is recommended.
- **Digital I/O Pullup Resistors:** RESET and A1-A4 are internally pulled up to VDD, while OSS is internally pulled down, each with a 50-k $\Omega$  (typical) resistor. A stronger pull-up/down resistor can be added externally such as a 10 k $\Omega$ , 1%, 0.063 W type in a SMT package. SCL, SDA1, SDAO, and INT require external pull-up resistors within a range of 1 k $\Omega$  to 10 k $\Omega$  depending on the total number of devices on the bus .
- **Ethernet Data Transformer (per port):** The Ethernet data transformer must be rated to operate within the IEEE802.3bt standard in the presence of the DC port current conditions. The transformer is also chosen to be compatible with the Ethernet PHY. The transformer may also be integrated into the RJ45 connector and cable terminations.
- **RJ45 Connector (per port):** The majority of the RJ45 connector requirements are mechanical in nature and include tab orientation, housing type (shielded or unshielded), or highly integrated. An integrated RJ45 consists of the Ethernet data transformer and cable terminations at a minimum. The integrated type may also contain the port TVS and common mode EMI filtering.
- **Cable Terminations (per port):** The cable terminations typically consist of series resistor (usually 75  $\Omega$ ) and capacitor (usually 10 nF) circuits from each data transformer center tap to a common node which is then bypassed to a chassis ground (or system earth ground) with a high-voltage capacitor (usually 1000 pF to 4700 pF at 2 kV).

## Typical Application (continued)

### 10.2.3 Application Curves

Unless otherwise noted, measurements taken on the TPS23881 EVM and Sifos PSA-3000 PowerSync Analyzer with PSA3202 test cards. Test conditions are  $T_J = 25\text{ }^\circ\text{C}$ ,  $V_{DD} = 3.3\text{ V}$ ,  $V_{PWR} = 54\text{ V}$ ,  $V_{DGND} = V_{AGND}$ , DGND, KSENSA, KSENSB, KSENSC and KSENSD connected to AGND, and all outputs are unloaded,  $2x\text{FBn} = 0$ . Positive currents are into pins.  $R_S = 0.200\text{ }\Omega$ , to KSENSA (SEN1 or SEN2), to KSENSB (SEN3 or SEN4), to KSENSC (SEN5 or SEN6) or to KSENSD (SEN7 or SEN8). All voltages are with respect to AGND unless otherwise noted. Operating registers loaded with default values unless otherwise noted.

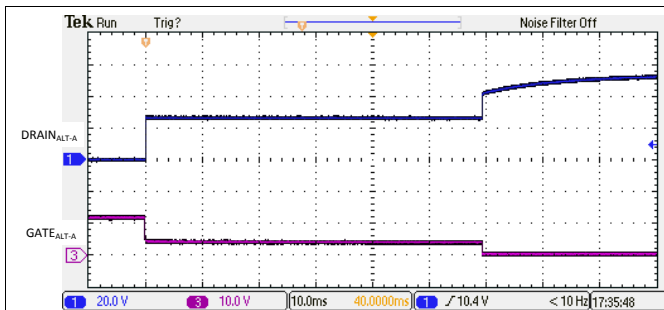


Figure 125. 2-Pair  $I_{LIM}$  Foldback and Turn Off

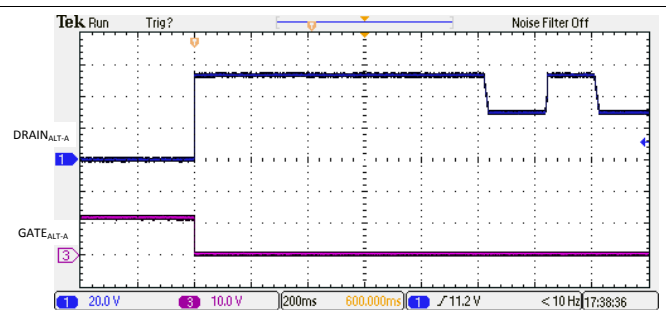


Figure 126. 2-Pair Backoff due to PCut Fault

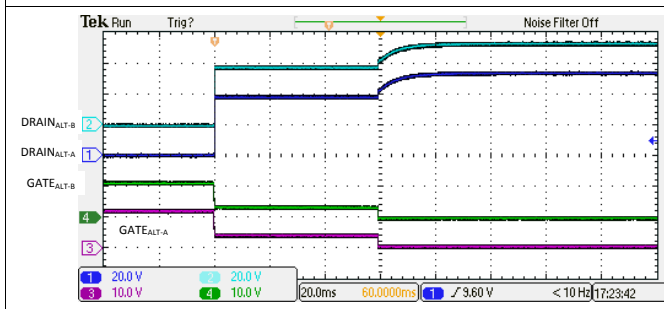


Figure 127. 4-Pair  $I_{LIM}$  Foldback and Turn Off

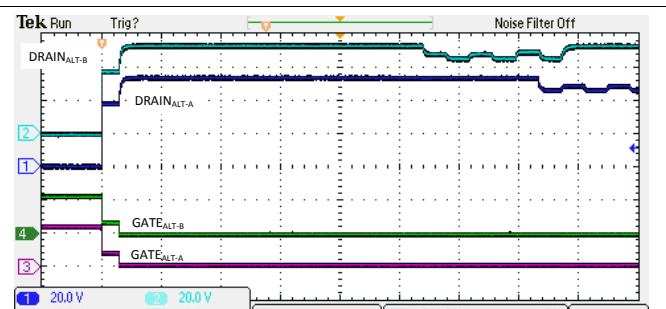


Figure 128. 4-Pair Backoff Due to  $I_{LIM}$  Fault

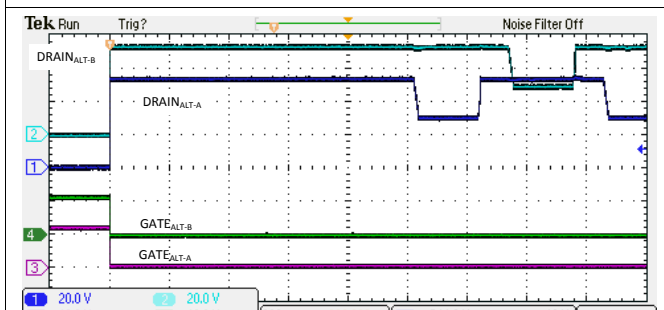


Figure 129. 4-Pair Backoff Due to 4PPCut Fault

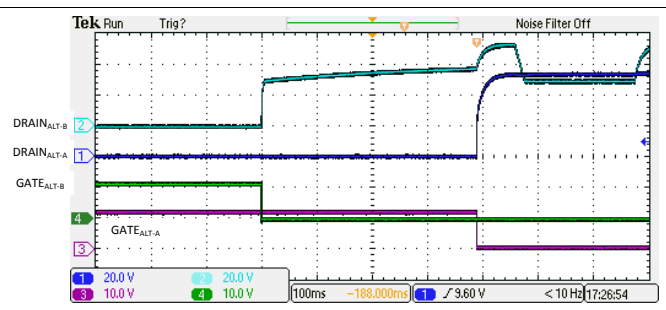


Figure 130. 4-Pair Single Signature Class 0-4 Disconnect

### Typical Application (continued)

Unless otherwise noted, measurements taken on the TPS23881 EVM and Sifos PSA-3000 PowerSync Analyzer with PSA3202 test cards. Test conditions are  $T_J = 25\text{ }^\circ\text{C}$ ,  $V_{VDD} = 3.3\text{ V}$ ,  $V_{VPWR} = 54\text{ V}$ ,  $V_{DGND} = V_{AGND}$ , DGND, KSENSA, KSENSB, KSENSC and KSENSD connected to AGND, and all outputs are unloaded,  $2x\text{FBn} = 0$ . Positive currents are into pins.  $R_S = 0.200\text{ }\Omega$ , to KSENSA (SEN1 or SEN2), to KSENSB (SEN3 or SEN4), to KSENSC (SEN5 or SEN6) or to KSENSD (SEN7 or SEN8). All voltages are with respect to AGND unless otherwise noted. Operating registers loaded with default values unless otherwise noted.

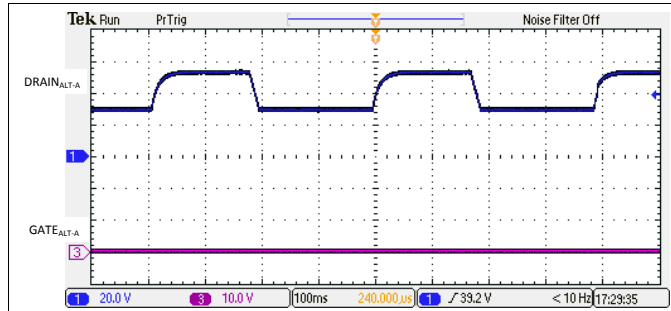


Figure 131. 2-Pair Open Circuit Detection Signature

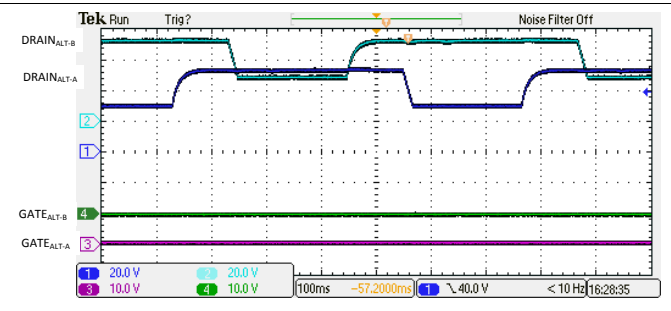


Figure 132. 4-Pair Open Circuit Detection Signature

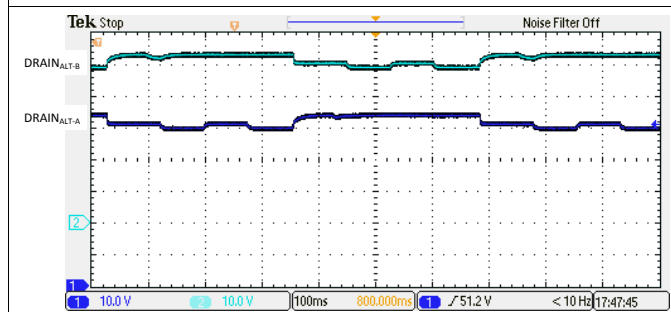


Figure 133. 4-Pair Low Resistance (11kΩ) Detection Signature

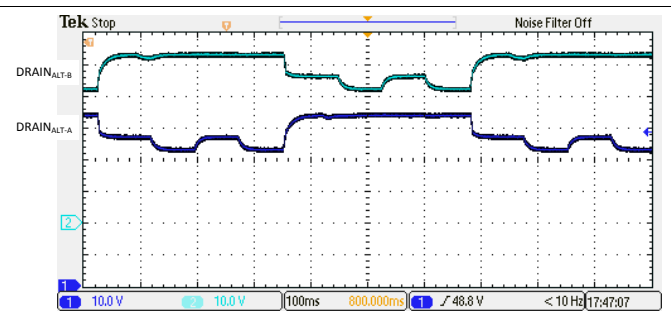


Figure 134. 4-Pair High Resistance (36kΩ) Detection Signature

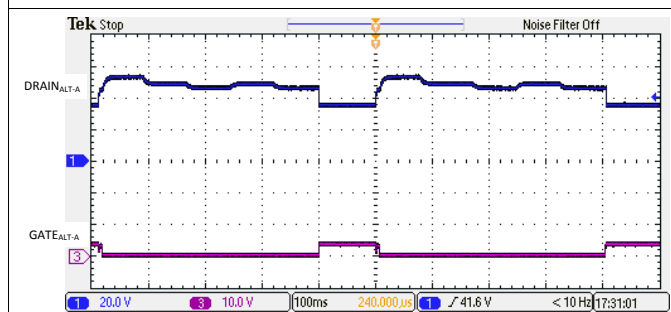


Figure 135. 2-Pair Semi-Auto Mode Discovery with a Valid Class 0-3 Load

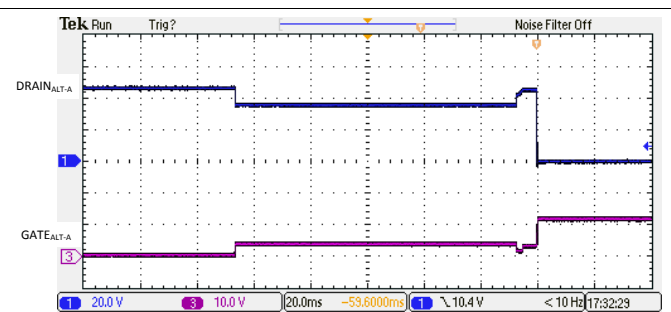


Figure 136. 2-Pair 1-Finger Classification and Turn On



### Typical Application (continued)

Unless otherwise noted, measurements taken on the TPS23881 EVM and Sifos PSA-3000 PowerSync Analyzer with PSA3202 test cards. Test conditions are  $T_J = 25\text{ }^\circ\text{C}$ ,  $V_{VDD} = 3.3\text{ V}$ ,  $V_{VPWR} = 54\text{ V}$ ,  $V_{DGND} = V_{AGND}$ , DGND, KSENSA, KSENSB, KSENSC and KSENSD connected to AGND, and all outputs are unloaded,  $2x\text{FBn} = 0$ . Positive currents are into pins.  $R_S = 0.200\text{ }\Omega$ , to KSENSA (SEN1 or SEN2), to KSENSB (SEN3 or SEN4), to KSENSC (SEN5 or SEN6) or to KSENSD (SEN7 or SEN8). All voltages are with respect to AGND unless otherwise noted. Operating registers loaded with default values unless otherwise noted.

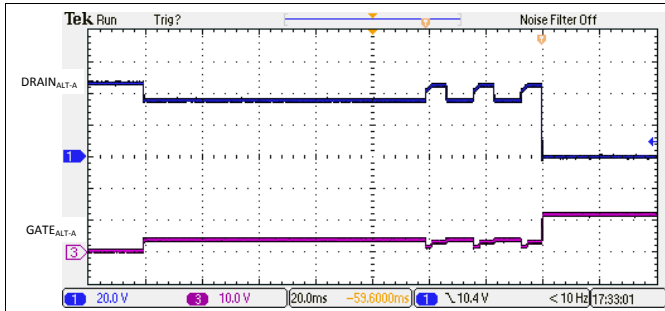


Figure 137. 2-Pair 3-Finger Classification and Turn On

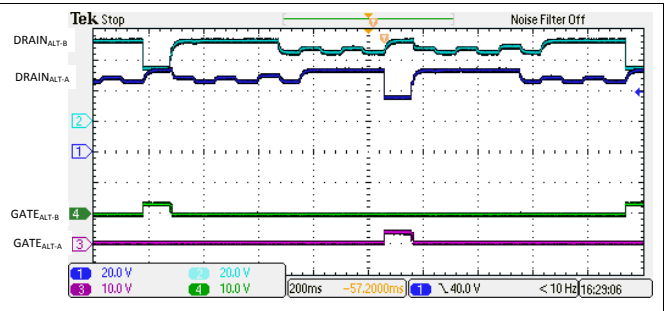


Figure 138. 4-Pair Semi-Auto Mode Discovery with a Valid Single Signature Class 0-3 Load

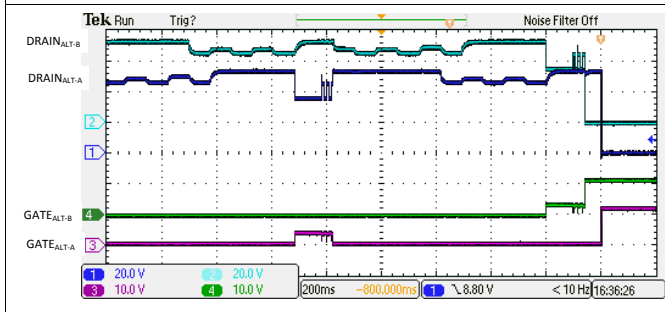


Figure 139. 4-Pair Single Signature Discovery and Turn On from Semi-Auto Mode

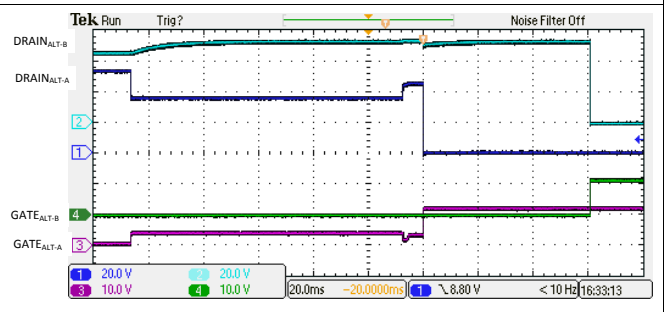


Figure 140. 4-Pair Single Signature 1-Finger Classification and Turn On

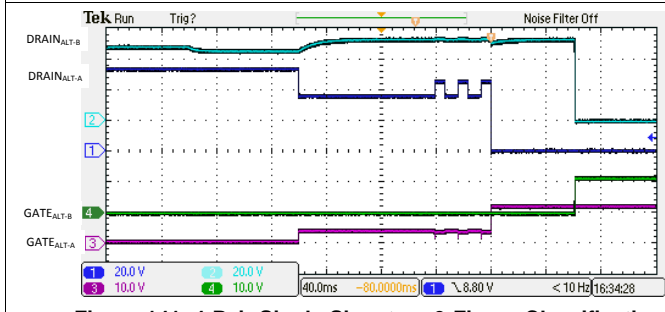


Figure 141. 4-Pair Single Signature 3-Finger Classification and Turn On

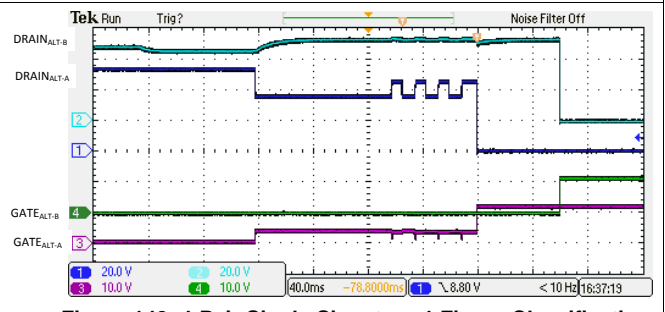


Figure 142. 4-Pair Single Signature 4-Finger Classification and Turn On

### Typical Application (continued)

Unless otherwise noted, measurements taken on the TPS23881 EVM and Sifos PSA-3000 PowerSync Analyzer with PSA3202 test cards. Test conditions are  $T_J = 25\text{ }^\circ\text{C}$ ,  $V_{DD} = 3.3\text{ V}$ ,  $V_{PWR} = 54\text{ V}$ ,  $V_{DGND} = V_{AGND}$ , DGND, KSENSA, KSENSB, KSENSC and KSENSD connected to AGND, and all outputs are unloaded,  $2x\text{FBn} = 0$ . Positive currents are into pins.  $R_S = 0.200\text{ }\Omega$ , to KSENSA (SEN1 or SEN2), to KSENSB (SEN3 or SEN4), to KSENSC (SEN5 or SEN6) or to KSENSD (SEN7 or SEN8). All voltages are with respect to AGND unless otherwise noted. Operating registers loaded with default values unless otherwise noted.

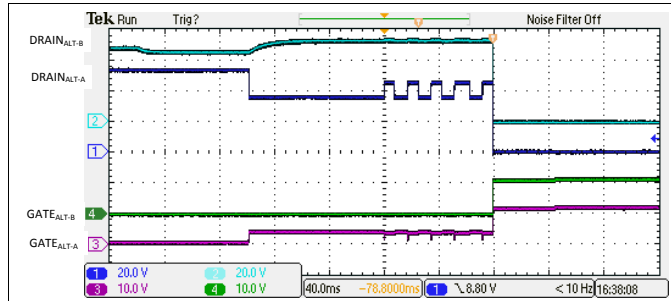


Figure 143. 4-Pair Single Signature 5-Finger Classification and Turn On

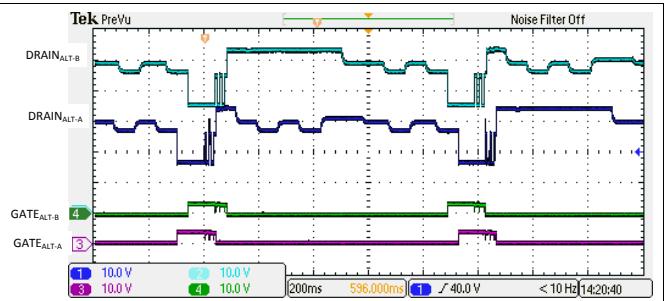


Figure 144. 4-Pair Semi-Auto Mode Discovery with a Valid Dual Signature Class 4D Load

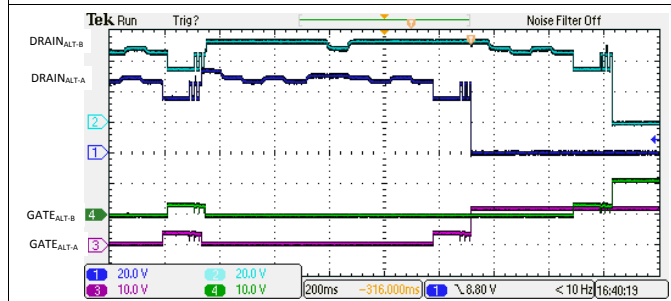


Figure 145. 4-Pair Dual Signature Discovery and Turn On from Semi-Auto Mode

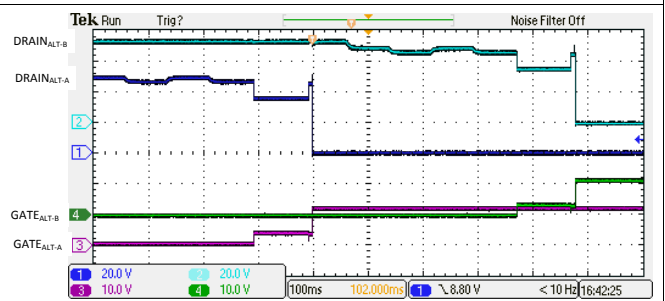


Figure 146. 4-Pair Dual Signature 1-Finger Classification and Turn On

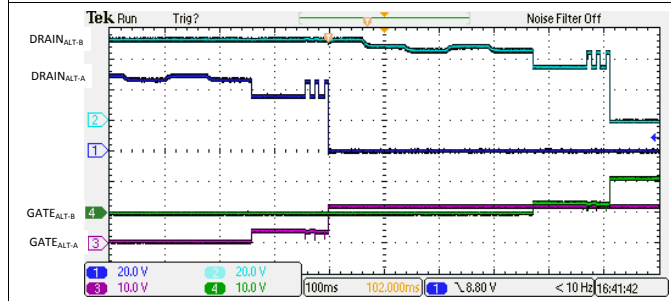


Figure 147. 4-Pair Dual Signature 3-Finger Classification and Turn On

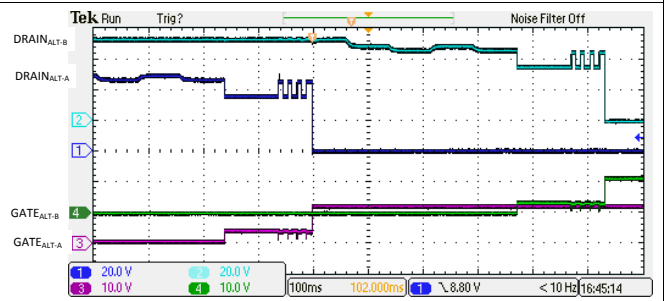


Figure 148. 4-Pair Dual Signature 4-Finger Classification and Turn On

## 11 Power Supply Recommendations

### 11.1 VDD

The recommended VDD supply voltage requirement is 3.3 V,  $\pm 0.3$  V. The TPS23881 requires approximately 6 mA typical and 12 mA maximum from the VDD supply. The VDD supply can be generated from VPWR with a buck-type regulator (A LM5017 based device is recommended) for a higher port count PSE using multiple TPS23881 devices operating in semiauto mode. The power supply design must ensure the VDD rail rises monotonically through the VDD UVLO thresholds without any droop under the UVLO\_fall threshold as the loads are turned on. This is accomplished with proper bulk capacitance across the VDD rail for the expected load current steps over worst case design corners. Furthermore, the combination of decoupling capacitance and bulk storage capacitance must hold the VDD rail above the UVLO\_fall threshold during any expected transient outages once power is applied.

### 11.2 VPWR

Although the supported VPWR supply voltage range is 44 V to 57 V, a power supply with a 50 V minimum output is required to provide PoE power levels from 30 W up to 60 W over 2-pair and 4-pair, and a 52 V minimum power supply is required to comply with Type-4 (up to 90W) IEEE requirements. The TPS23881 requires approximately 10-mA typical and 12-mA maximum from the VPWR supply, but the total output current required from the VPWR supply depends on the number and type of ports required in the system. The TPS23881 can be configured to support either 15.5 W, 30 W, 45 W, 60 W, 75W, or 90 W per port and the power limit is set proportionally at turn on. The port power limit,  $P_{CUT}$ , is also programmable to provide even greater system design flexibility. However, it is generally recommend to size the VPWR supply accordingly to the PoE Type to be supported. As an example, a 130 W or greater power supply would be recommended for eight type 1 (15.5 W each) ports, or a 500 W or greater power supply is recommended for eight 4-pair type 3 (60 W) ports, assuming maximum port and standby currents.

---

#### NOTE

In IEEE complaint applications, only 4-Pair configured ports are capable of supporting power levels greater than 30 W.

---

## 12 Layout

### 12.1 Layout Guidelines

#### 12.1.1 Kelvin Current Sensing Resistors

Load current in each PSE channel is sensed as the voltage across a low-end current-sense resistor with a value of 200 mΩ. For more accurate current sensing, kelvin sensing of the low end of the current-sense resistor is provided through pins KSENSA for channels 1 and 2, KSENSB for channels 3 and 4, KSENSC for channels 5 and 6 and KSENSD for channels 7 and 8.

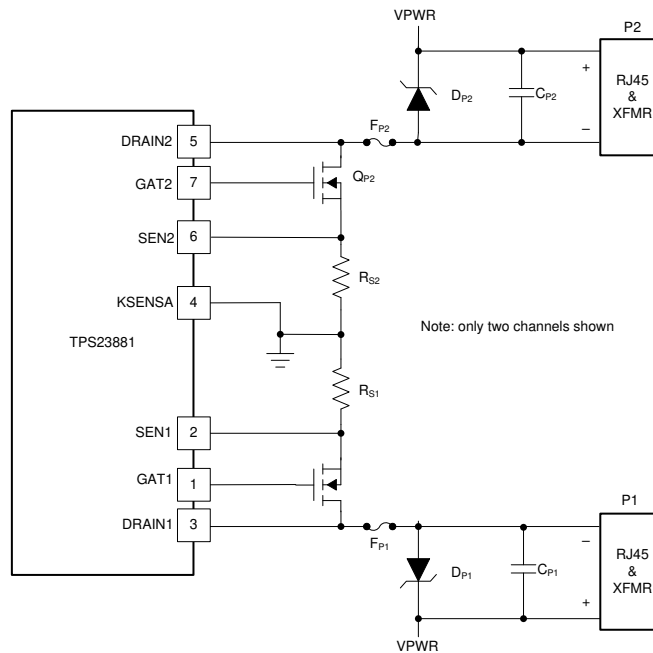


Figure 149. Kelvin Current-Sense Connection

KSENSA is shared between SEN1 and SEN2, KSENSB is shared between SEN3 and SEN4, KSENSC is shared between SEN5 and SEN6, and KSENSD is shared between SEN7 and SEN8. To optimize the accuracy of the measurement, the PCB layout must be done carefully to minimize impact of PCB trace resistance. Refer to as an example.

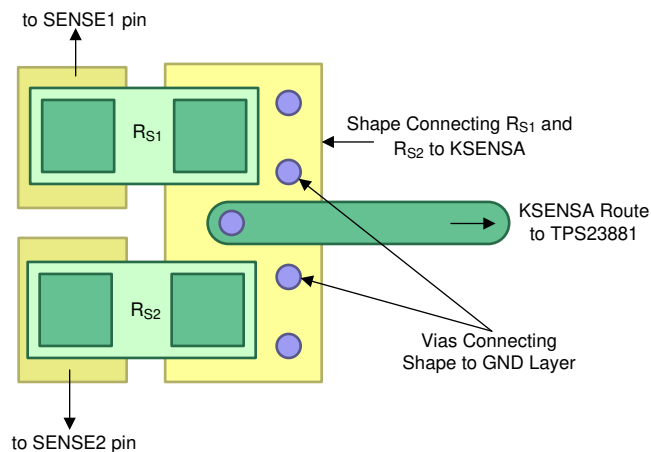
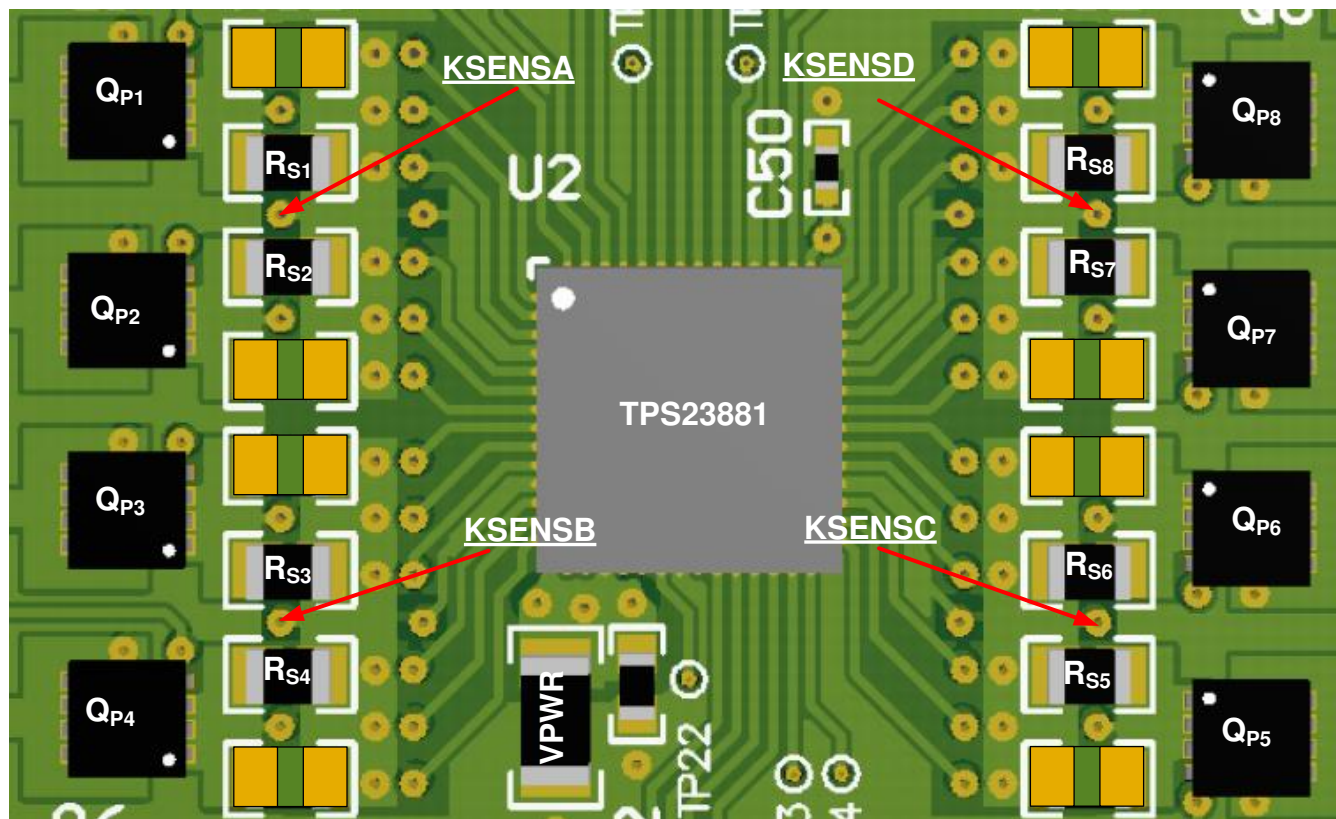


Figure 150. Kelvin Sense Layout Example

## 12.2 Layout Example



Note: PCB layout includes footprints for optional parallel  $R_{SENSE}$  resistors

Figure 151. Eight Port Layout Example (Top Side)

### 12.2.1 Component Placement and Routing Guidelines

#### 12.2.1.1 Power Pin Bypass Capacitors

- $C_{VPWR}$ : Place close to pin 17 (VPWR) and connect with low inductance traces and vias according to Figure 151.
- $C_{VDD}$ : Place close to pin 43 (VDD) and connect with low inductance traces and vias according to Figure 151
- $C_{AUTO}^{(2)}$ : Place close to pin 52 (AUTO) and connect with low inductance traces and vias. <sup>(2)</sup>

#### 12.2.1.2 Per-Port Components

- $R_{SnA} / R_{SnB}$ : Place according to in a manner that facilitates a clean Kelvin connection with KSENSE A/B/C/D.
- $Q_{Pn}$ : Place  $Q_{Pn}$  around the TPS23881 as illustrated in Figure 151. Provide sufficient copper from  $Q_{Pn}$  drain to  $F_{Pn}$ .
- $F_{Pn}$ ,  $C_{Pn}$ ,  $D_{PnA}$ ,  $D_{PnB}$ : Place this circuit group near the RJ45 port connector (or port power interface if a daughter board type of interface is used as illustrated in Figure 151). Connect this circuit group to  $Q_{Pn}$  drain or GND (TPS23881- AGND) using low inductance traces.

(2) Only required if  $R_{AUTO}$  is also connected to the AUTO pin

## 13 Device and Documentation Support

### 13.1 Documentation Support

#### 13.1.1 Related Documentation

For related documentation see the following:

Texas Instruments, [TPS23881EVM User's Guide](#)

### 13.2 Receiving Notification of Documentation Updates

To receive notification of documentation updates, navigate to the device product folder on ti.com. In the upper right corner, click on *Alert me* to register and receive a weekly digest of any product information that has changed. For change details, review the revision history included in any revised document.

### 13.3 Support Resources

[TI E2E™ support forums](#) are an engineer's go-to source for fast, verified answers and design help — straight from the experts. Search existing answers or ask your own question to get the quick design help you need.

Linked content is provided "AS IS" by the respective contributors. They do not constitute TI specifications and do not necessarily reflect TI's views; see TI's [Terms of Use](#).

### 13.4 Trademarks

E2E is a trademark of Texas Instruments.

All other trademarks are the property of their respective owners.

### 13.5 Electrostatic Discharge Caution



This integrated circuit can be damaged by ESD. Texas Instruments recommends that all integrated circuits be handled with appropriate precautions. Failure to observe proper handling and installation procedures can cause damage.

ESD damage can range from subtle performance degradation to complete device failure. Precision integrated circuits may be more susceptible to damage because very small parametric changes could cause the device not to meet its published specifications.

### 13.6 Glossary

[SLYZ022](#) — *TI Glossary*.

This glossary lists and explains terms, acronyms, and definitions.

## 14 Mechanical, Packaging, and Orderable Information

The following pages include mechanical, packaging, and orderable information. This information is the most current data available for the designated devices. This data is subject to change without notice and revision of this document. For browser-based versions of this data sheet, refer to the left-hand navigation.

**PACKAGING INFORMATION**

Orderable Device	Status (1)	Package Type	Package Drawing	Pins	Package Qty	Eco Plan (2)	Lead/Ball Finish (6)	MSL Peak Temp (3)	Op Temp (°C)	Device Marking (4/5)	Samples
TPS23881ARTQR	ACTIVE	QFN	RTQ	56	2000	Green (RoHS & no Sb/Br)	CU NIPDAUAG	Level-3-260C-168 HR	-40 to 125	TPS23881A	<a href="#">Samples</a>
TPS23881ARTQT	ACTIVE	QFN	RTQ	56	250	Green (RoHS & no Sb/Br)	CU NIPDAUAG	Level-3-260C-168 HR	-40 to 125	TPS23881A	<a href="#">Samples</a>
TPS23881RTQR	ACTIVE	QFN	RTQ	56	2000	Green (RoHS & no Sb/Br)	CU NIPDAUAG	Level-3-260C-168 HR	-40 to 125	TPS23881	<a href="#">Samples</a>
TPS23881RTQT	ACTIVE	QFN	RTQ	56	250	Green (RoHS & no Sb/Br)	CU NIPDAUAG	Level-3-260C-168 HR	-40 to 125	TPS23881	<a href="#">Samples</a>

(1) The marketing status values are defined as follows:

**ACTIVE:** Product device recommended for new designs.

**LIFEBUY:** TI has announced that the device will be discontinued, and a lifetime-buy period is in effect.

**NRND:** Not recommended for new designs. Device is in production to support existing customers, but TI does not recommend using this part in a new design.

**PREVIEW:** Device has been announced but is not in production. Samples may or may not be available.

**OBSOLETE:** TI has discontinued the production of the device.

(2) **RoHS:** TI defines "RoHS" to mean semiconductor products that are compliant with the current EU RoHS requirements for all 10 RoHS substances, including the requirement that RoHS substance do not exceed 0.1% by weight in homogeneous materials. Where designed to be soldered at high temperatures, "RoHS" products are suitable for use in specified lead-free processes. TI may reference these types of products as "Pb-Free".

**RoHS Exempt:** TI defines "RoHS Exempt" to mean products that contain lead but are compliant with EU RoHS pursuant to a specific EU RoHS exemption.

**Green:** TI defines "Green" to mean the content of Chlorine (Cl) and Bromine (Br) based flame retardants meet JS709B low halogen requirements of <=1000ppm threshold. Antimony trioxide based flame retardants must also meet the <=1000ppm threshold requirement.

(3) MSL, Peak Temp. - The Moisture Sensitivity Level rating according to the JEDEC industry standard classifications, and peak solder temperature.

(4) There may be additional marking, which relates to the logo, the lot trace code information, or the environmental category on the device.

(5) Multiple Device Markings will be inside parentheses. Only one Device Marking contained in parentheses and separated by a "-" will appear on a device. If a line is indented then it is a continuation of the previous line and the two combined represent the entire Device Marking for that device.

(6) Lead/Ball Finish - Orderable Devices may have multiple material finish options. Finish options are separated by a vertical ruled line. Lead/Ball Finish values may wrap to two lines if the finish value exceeds the maximum column width.

**Important Information and Disclaimer:**The information provided on this page represents TI's knowledge and belief as of the date that it is provided. TI bases its knowledge and belief on information provided by third parties, and makes no representation or warranty as to the accuracy of such information. Efforts are underway to better integrate information from third parties. TI has taken and



continues to take reasonable steps to provide representative and accurate information but may not have conducted destructive testing or chemical analysis on incoming materials and chemicals. TI and TI suppliers consider certain information to be proprietary, and thus CAS numbers and other limited information may not be available for release.

In no event shall TI's liability arising out of such information exceed the total purchase price of the TI part(s) at issue in this document sold by TI to Customer on an annual basis.



## TAPE AND REEL INFORMATION



### QUADRANT ASSIGNMENTS FOR PIN 1 ORIENTATION IN TAPE



\*All dimensions are nominal

Device	Package Type	Package Drawing	Pins	SPQ	Reel Diameter (mm)	Reel Width W1 (mm)	A0 (mm)	B0 (mm)	K0 (mm)	P1 (mm)	W (mm)	Pin1 Quadrant
TPS23881ARTQR	QFN	RTQ	56	2000	330.0	16.4	8.3	8.3	1.1	12.0	16.0	Q2
TPS23881ARTQT	QFN	RTQ	56	250	180.0	16.4	8.3	8.3	1.1	12.0	16.0	Q2
TPS23881RTQR	QFN	RTQ	56	2000	330.0	16.4	8.3	8.3	1.1	12.0	16.0	Q2
TPS23881RTQT	QFN	RTQ	56	250	180.0	16.4	8.3	8.3	1.1	12.0	16.0	Q2

**TAPE AND REEL BOX DIMENSIONS**


\*All dimensions are nominal

Device	Package Type	Package Drawing	Pins	SPQ	Length (mm)	Width (mm)	Height (mm)
TPS23881ARTQR	QFN	RTQ	56	2000	367.0	367.0	38.0
TPS23881ARTQT	QFN	RTQ	56	250	210.0	185.0	35.0
TPS23881RTQR	QFN	RTQ	56	2000	367.0	367.0	38.0
TPS23881RTQT	QFN	RTQ	56	250	210.0	185.0	35.0

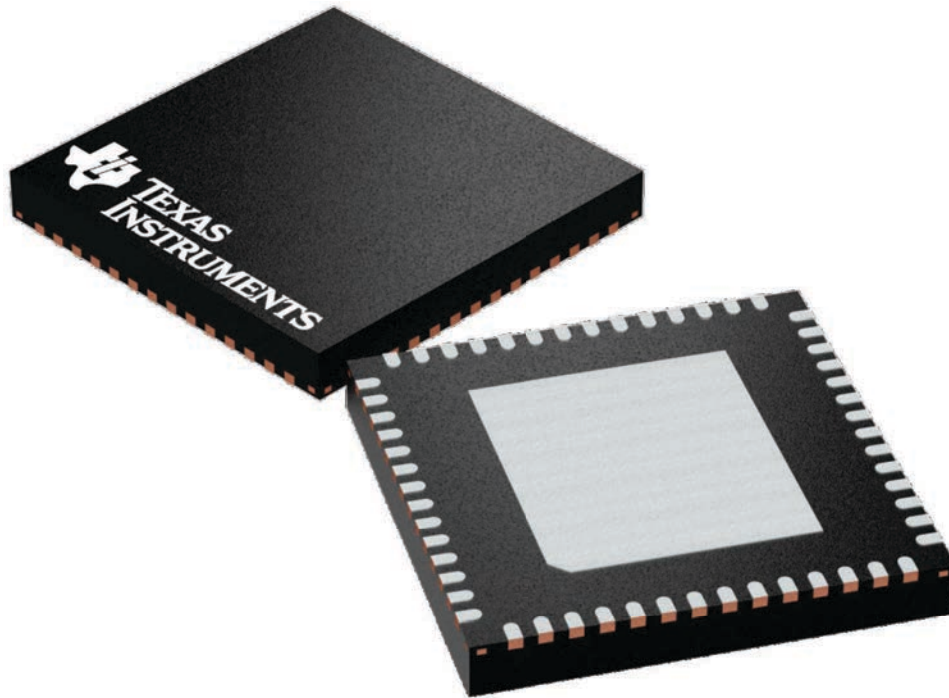
## GENERIC PACKAGE VIEW

**RTQ 56**

**VQFN - 1 mm max height**

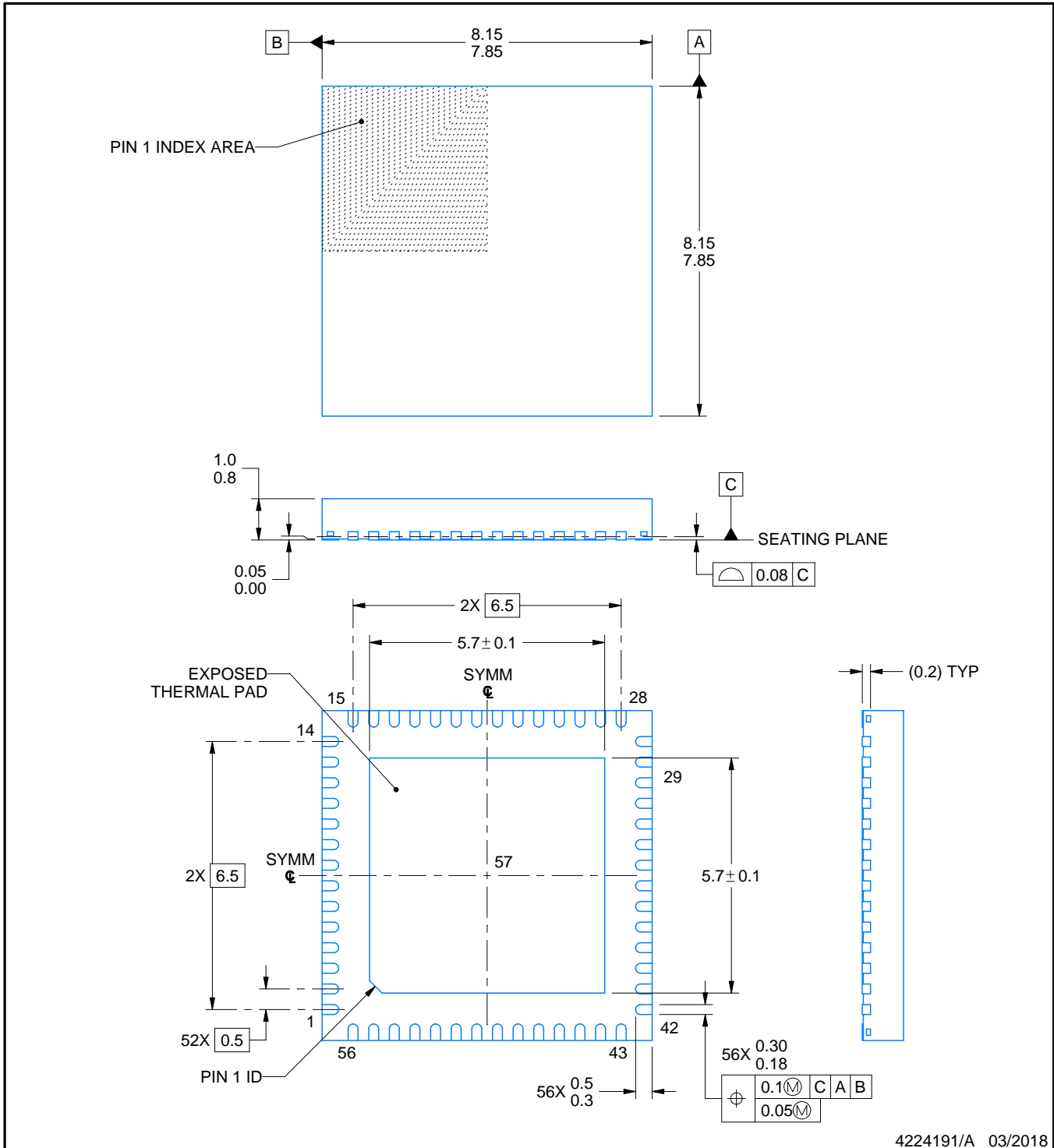
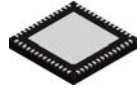
8 x 8, 0.5 mm pitch

PLASTIC QUAD FLATPACK - NO LEAD



Images above are just a representation of the package family, actual package may vary.  
Refer to the product data sheet for package details.

4224653/A



4224191/A 03/2018

NOTES:

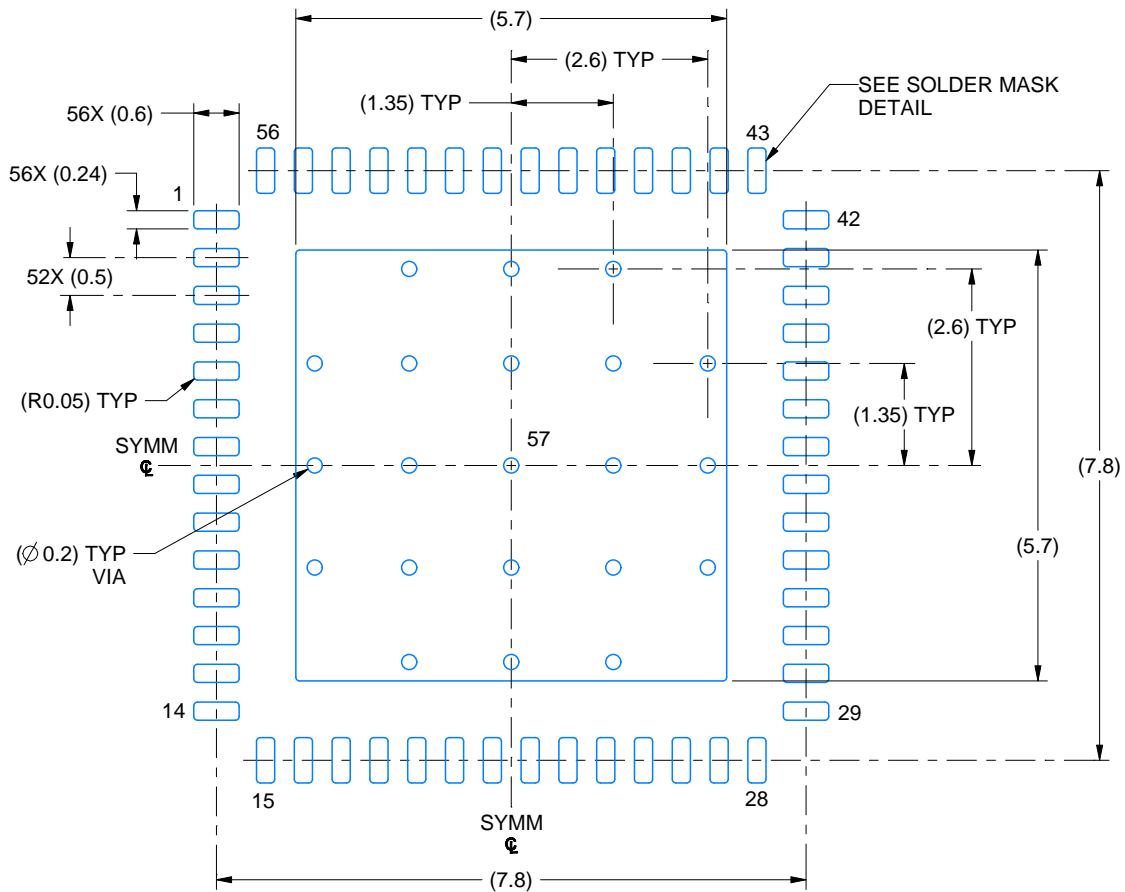
1. All linear dimensions are in millimeters. Any dimensions in parenthesis are for reference only. Dimensioning and tolerancing per ASME Y14.5M.
2. This drawing is subject to change without notice.
3. The package thermal pad must be soldered to the printed circuit board for thermal and mechanical performance.

# EXAMPLE BOARD LAYOUT

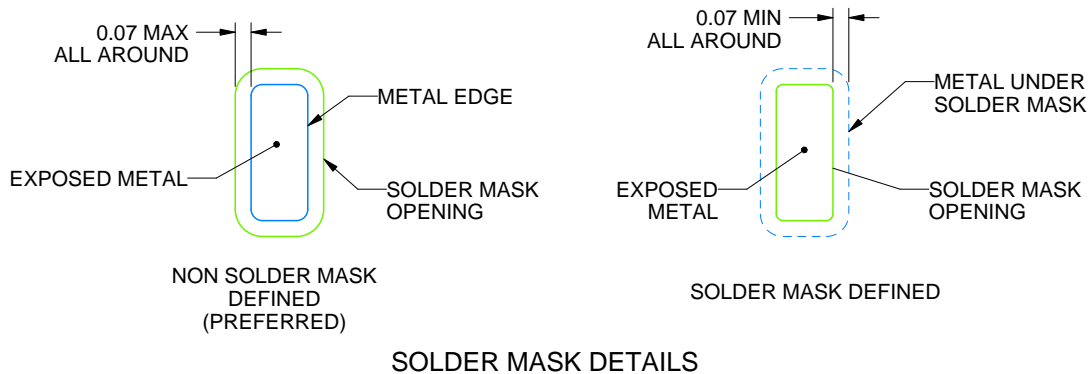
RTQ0056E

VQFN - 1 mm max height

PLASTIC QUAD FLATPACK - NO LEAD



LAND PATTERN EXAMPLE  
EXPOSED METAL SHOWN  
SCALE: 10X



4224191/A 03/2018

NOTES: (continued)

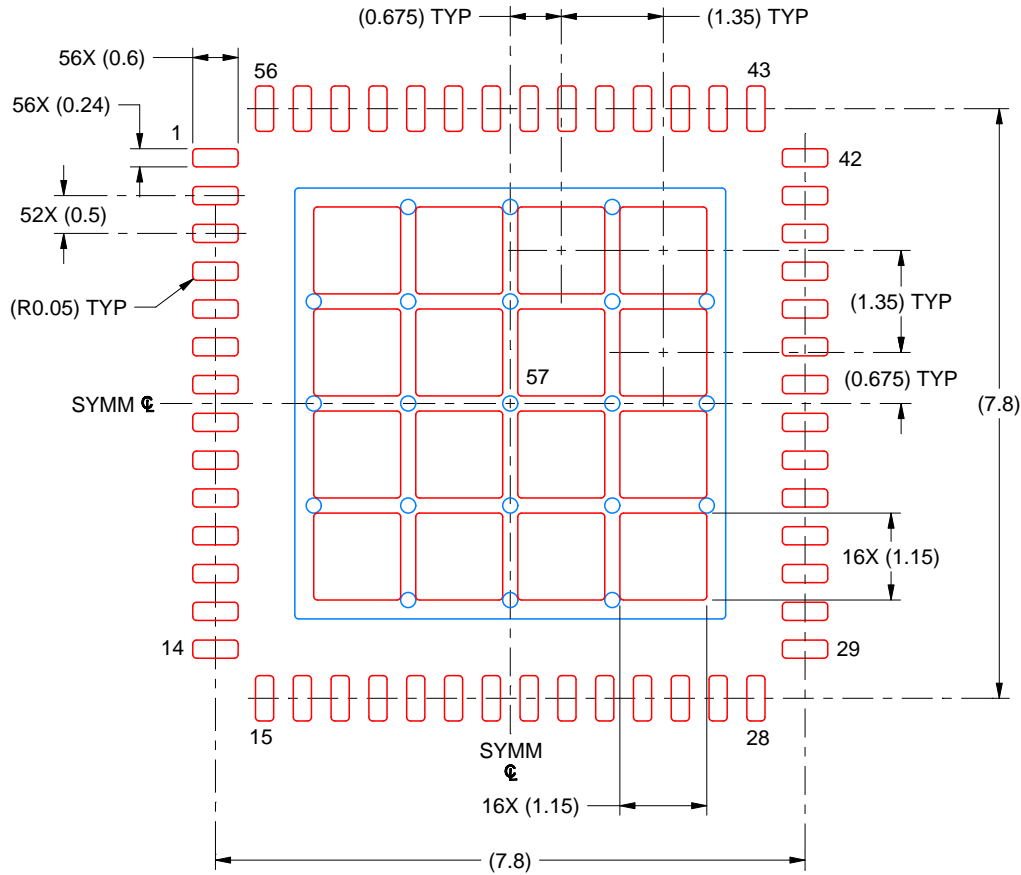
- This package is designed to be soldered to a thermal pad on the board. For more information, see Texas Instruments literature number SLUA271 ([www.ti.com/lit/sluea271](http://www.ti.com/lit/sluea271)).
- Vias are optional depending on application, refer to device data sheet. If any vias are implemented, refer to their locations shown on this view. It is recommended that vias under paste be filled, plugged or tented.

# EXAMPLE STENCIL DESIGN

RTQ0056E

VQFN - 1 mm max height

PLASTIC QUAD FLATPACK - NO LEAD



SOLDER PASTE EXAMPLE  
 BASED ON 0.125 MM THICK STENCIL  
 SCALE: 10X

EXPOSED PAD 57  
 65% PRINTED SOLDER COVERAGE BY AREA UNDER PACKAGE

4224191/A 03/2018

NOTES: (continued)

6. Laser cutting apertures with trapezoidal walls and rounded corners may offer better paste release. IPC-7525 may have alternate design recommendations.

## IMPORTANT NOTICE AND DISCLAIMER

TI PROVIDES TECHNICAL AND RELIABILITY DATA (INCLUDING DATASHEETS), DESIGN RESOURCES (INCLUDING REFERENCE DESIGNS), APPLICATION OR OTHER DESIGN ADVICE, WEB TOOLS, SAFETY INFORMATION, AND OTHER RESOURCES "AS IS" AND WITH ALL FAULTS, AND DISCLAIMS ALL WARRANTIES, EXPRESS AND IMPLIED, INCLUDING WITHOUT LIMITATION ANY IMPLIED WARRANTIES OF MERCHANTABILITY, FITNESS FOR A PARTICULAR PURPOSE OR NON-INFRINGEMENT OF THIRD PARTY INTELLECTUAL PROPERTY RIGHTS.

These resources are intended for skilled developers designing with TI products. You are solely responsible for (1) selecting the appropriate TI products for your application, (2) designing, validating and testing your application, and (3) ensuring your application meets applicable standards, and any other safety, security, or other requirements. These resources are subject to change without notice. TI grants you permission to use these resources only for development of an application that uses the TI products described in the resource. Other reproduction and display of these resources is prohibited. No license is granted to any other TI intellectual property right or to any third party intellectual property right. TI disclaims responsibility for, and you will fully indemnify TI and its representatives against, any claims, damages, costs, losses, and liabilities arising out of your use of these resources.

TI's products are provided subject to TI's Terms of Sale ([www.ti.com/legal/termsofsale.html](http://www.ti.com/legal/termsofsale.html)) or other applicable terms available either on [ti.com](http://ti.com) or provided in conjunction with such TI products. TI's provision of these resources does not expand or otherwise alter TI's applicable warranties or warranty disclaimers for TI products.

Mailing Address: Texas Instruments, Post Office Box 655303, Dallas, Texas 75265  
Copyright © 2019, Texas Instruments Incorporated