

Product Overview

The TQP5525 is high power WLAN power amplifier module containing an internally matched 3-stage PA, compensated DC biasing circuit and output power detector. This PA module provides high gain (32 dB), high linearity, industry leading EVM floor, and excellent spectral purity for wideband OFDM applications. The architecture and interface are optimized for the most stringent EVM requirements of next generation 802.11.ac WLAN devices.

The TQP5525 features chipset logic compatible control voltages and buffered PA enable pin (PAEN) all of which draw very low current to facilitate ease of use and compatibility with current and future transceiver generations. With its optimized power dissipation, this amplifier module is well suited for implementation into next generation MIMO configurations and well designed to work with or without digital pre-distortion (DPD).

The TQP5525 is manufactured using Qorvo's high-reliability HBT technology and is assembled in a small footprint 4.0 mm x 4.0 mm x 0.85 mm 20 pad QFN package.

Functional Block Diagram

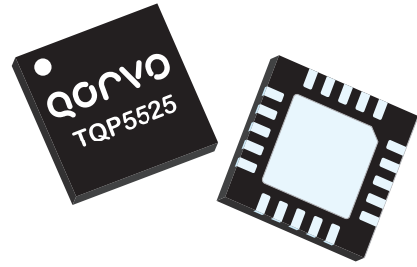
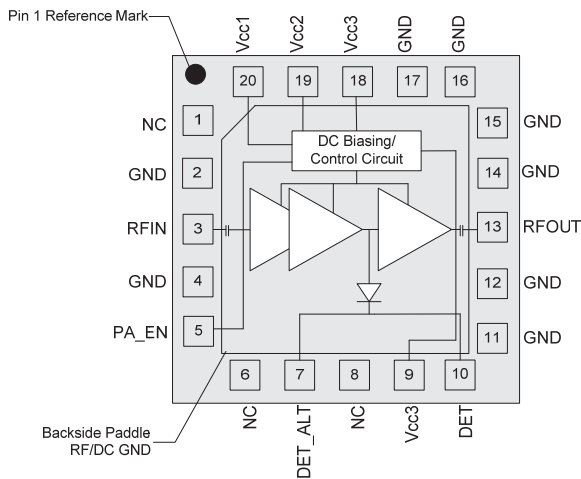

20 Pad 4.0 x 4.0 x 0.85 mm QFN Package

Key Features

- Fully Integrated 802.11ac Power Amplifier Module With Power Detector
- Internally Matched Input / Output
- Temperature Compensated Bias Network
- High Gain = 32 dB
- Integrated CMOS Compatible Logic and Shutdown
- $P_{OUT} = +25$ dBm (typ.) at -35 dB EVM, (802.11n / HT40 / MCS7)
- $P_{OUT} = +18$ dBm (typ.) at -40 dB EVM, (802.11ac / VHT80 / MCS9)
- $P_{OUT} = +26$ dBm (typ.) at -30 dB EVM, (802.11ac / VHT80 / MCS9)
- Supply Voltage: +3.3 V to +5.0 V
- Leadless 4.0 x 4.0 x 0.85 mm Pb-Free QFN Package

Applications

- 802.11a/n/ac Wireless LAN Systems
- CPE (Set Top Box, Routers, Gateways)
- WiFi Access Points and Small Cells
- Telematics
- Gaming and Infotainment
- Portable Devices
- Point-to-point and Backhaul
- ISM Band

Ordering Information

Part No.	Description
TQP5525	2500 Pieces on a 13" reel (standard)
TQP5525-EVB	Assembled Evaluation Board

Absolute Maximum Ratings

Parameter	Rating
Storage Temperature	-40 to 150 °C
Case Temperature, Survival	-40 to 100 °C
RF Input Power, CW, 50 Ω, T = 25 °C	+5 dBm
Device Voltage	+6.0 V

Operation of this device outside the parameter ranges given above may cause permanent damage.

Recommended Operating Conditions

Parameter	Min	Typ	Max	Units
V _{CC1} , V _{CC2} , V _{CC3}	+3.15	+5	+5.25	V
T _{AMB}	-40	+25	+85	°C
T _j (for >10 ⁶ hours MTTF)			+170	°C

Electrical performance is measured under conditions noted in the electrical specifications table. Specifications are not guaranteed over all recommended operating conditions.

Electrical Specifications – DC Characteristics

Parameter	Conditions	Min	Typ	Max	Units
Quiescent Current	No RF		350	400	mA
Operational Current	P _{out} = +21 dBm, 802.11ac, MCS9, HT80		475	550	mA
	P _{out} = +24 dBm, 802.11ac, MCS9, HT80		600	675	
	P _{out} = +27.5 dBm, 802.11ac, MCS0, HT20		750	850	
TX Shut Down Current	PA_EN= Low, No RF		8		μA
PA Enable Voltage	Input Voltage for High State	+1.8	+3.0	V _{CC1}	V
	Input Voltage for Low State		0	+0.45	
PA Enable Current			20	100	μA
Rise/Fall Time			0.4	0.8	μs
Thermal Resistance, θ _{jc}	Junction to backside paddle		17		°C/W

Notes:

1. Test conditions unless otherwise noted: V_{CC1}=V_{CC2}=V_{CC3} = +5.0 V, Temp.=+25°C.

Performance Over Voltage

Parameter	Conditions	Typical Value			Units
Voltage (V _{CC1} , V _{CC2} , V _{CC3})		+3.3	+4.2	+5.0	Volts
Small Signal Gain	f = 5250 – 5925 MHz	30.5	31.5	32	dB
P _{out} (11ac / VHT80 / MCS9)	DEVM = -35 dB	+22	+24	+25	dBm
P _{out} (11ac / HT20 / MCS0)	DEVM = -30 dB	+24	+26	+27	dBm
Operating Current	802.11ac / VHT80 / MCS9, DEVM = -35 dB	470	540	600	mA

Notes:

1. Test conditions unless otherwise noted: Temp.=+25°C.

Logic Truth Table

PA Mode	PA_EN State
Disabled	Low
Enabled	High

Electrical Specifications

Parameter	Conditions ⁽¹⁾	Min	Typ	Max	Units
Operational Freq. Range		4900		5925	MHz
3dB Bandwidth	At each 802.11ac VHT80 channel	4740		6100	MHz
Saturation Power (P _{sat})	f = 4900 – 5150 MHz		+31.5		dBm
	f = 5150 – 5925 MHz		+34		
P1dB	f = 4900 MHz – 5150 MHz	+29.5	+30.5		dBm
	f = 5150 MHz – 5925 MHz	+30	+32		
Small Signal Gain	f = 4900 – 5250 MHz	28	31	35	dB
	f = 5250 – 5925 MHz	29	32	37	
Gain OOB	Absolute gain, f = 3433 – 3917 MHz		0		dB
	Absolute gain, f = 1716 – 1959 MHz		-50		
Gain Flatness Across Band	For any 80 MHz BW, 802.11ac/VHT80		± 0.25		dB
Spectral Emission Mask Margin Relative to 11ac standard (802.11ac/HT20/MCS0)	P _{out} = +24 dBm, f = 5150 – 525 MHz		5		dB
	P _{out} = +26.5 dBm, f = 5250 – 5725 MHz		5		
	P _{out} = +27.5 dBm, f = 5725 – 5925 MHz		5		
PA Noise Figure			7		dB
Input Return Loss			10		dB
Output Return Loss			10		dB
CW Signal Phase Variation Harmonics (2f ₀)	P _{out} = +18 dBm to +24 dBm		1.0		Deg.
TX Harmonics (2f ₀) (802.11ac/VHT20/MCS0)	P _{out} = +22 dBm, f = 5150 – 5250 MHz		-45		dBm/ MHz
	P _{out} = +26.5 dBm, f = 5250 – 5725 MHz		-45		
	P _{out} = +27.5 dBm, f = 5725 – 5925 MHz		-45		
TX Harmonics (3f ₀) (802.11ac/VHT20/MCS0)	P _{out} = +22 dBm, f = 5150 – 5250 MHz		-45		dBm/ MHz
	P _{out} = +26.5 dBm, f = 5250 – 5725 MHz		-45		
	P _{out} = +27.5 dBm, f = 5725 – 5925 MHz		-45		
DEVM (802.11n/HT40/MCS7)	P _{out} = +25 dBm		-33		dB
DEVM (802.11ac/VHT80/MCS9)	P _{out} = +18 dBm		-40	-36	dB
	P _{out} = +24 dBm		-36	-31	
DEVM (802.11ac/VHT20/MCS0)	P _{out} = +27 dBm		-26		dB
Detector Voltage	No RF	+0.25	+0.35	+0.38	V
	P _{out} = +27.5 dBm	+0.8	+0.9	+1.2	
Stability	P _{out} = +28 dBm, VSWR = 6:1, all phases	All non-harmonically related outputs < -50 dBc/100 kHz			-

Notes:
 1. Test conditions unless otherwise noted: V_{CC1} = V_{CC2} = V_{CC3} = +5.0 V Temp. = +25 °C, Measured on TQP5525-EVB, PA_EN High = +3.0 V, -45 dBm EVM source

Timing Diagram

Transmit Timing Diagram
RF/DC Power On/Off Sequence

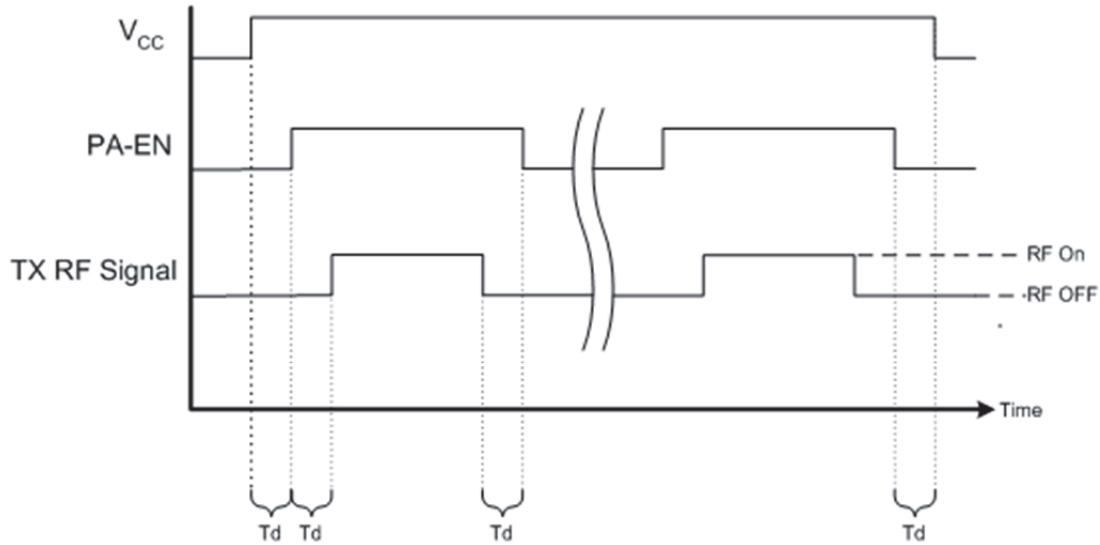

Notes: DC and RF signal levels per data sheet specification.
Observe the timing sequence shown in the diagram above and described below.

- Apply V_{CC} prior to turning on or pulsing PA enable.
- Turn off PA enable prior to turning off V_{CC} .
- Turn on PA enable prior to applying RF signal.
- Turn off RF signal prior to turning off PA enable.

Performance Plots $V_{CC} = +5\text{ V}$

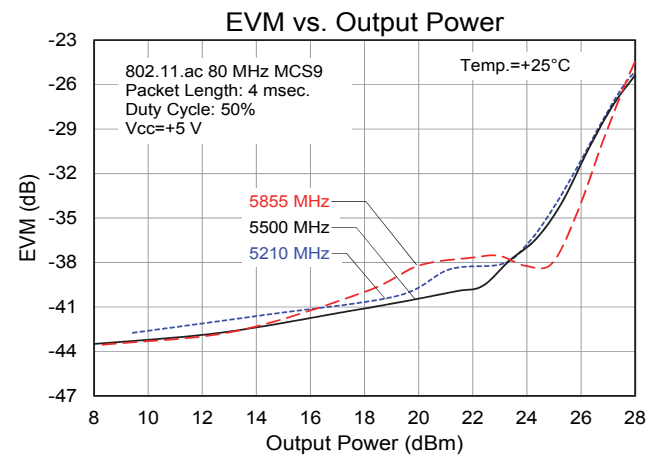
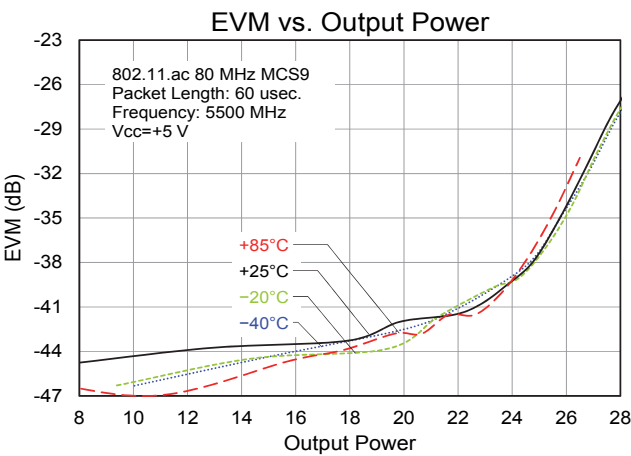
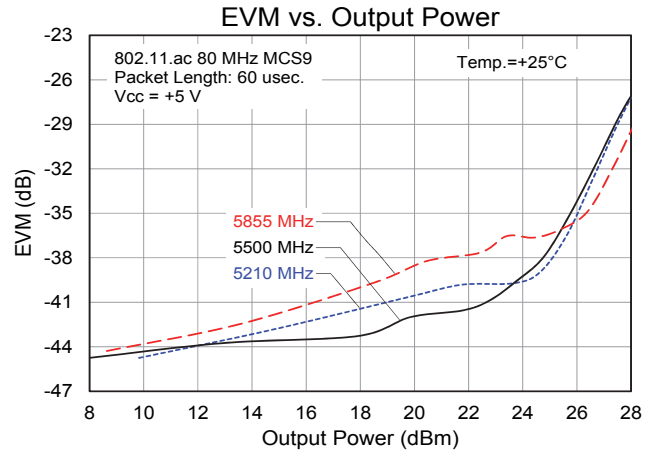
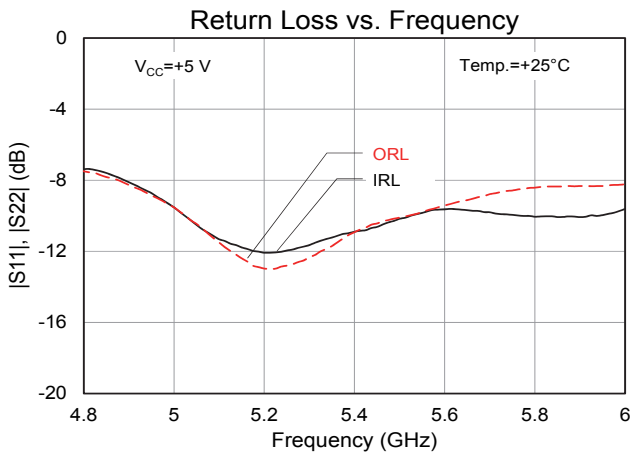
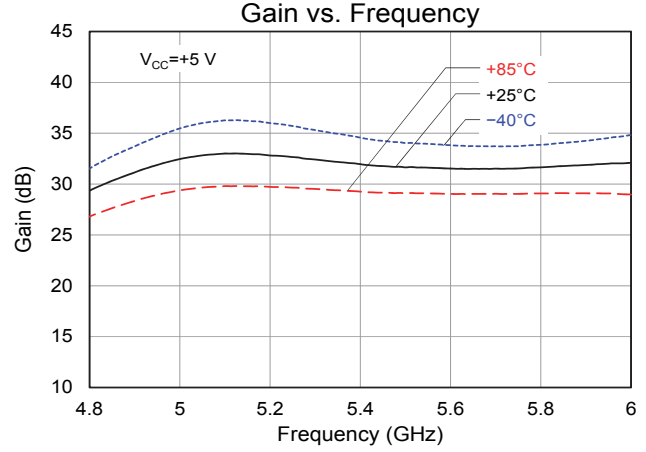
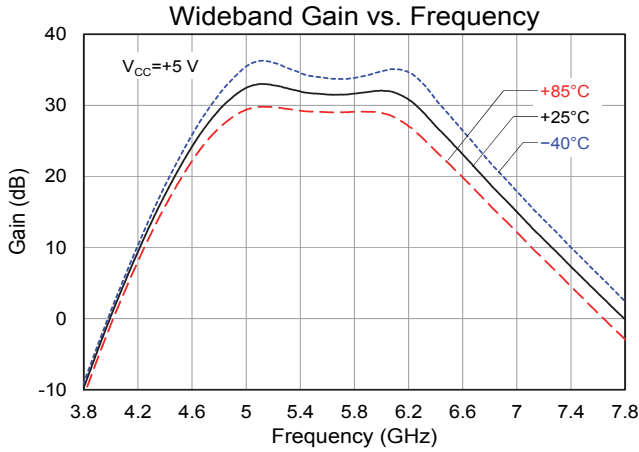

Performance Plots Vcc= +5 V (cont.)

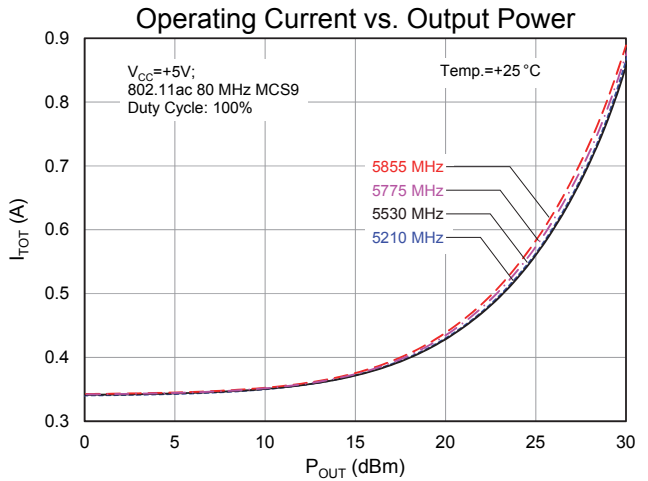
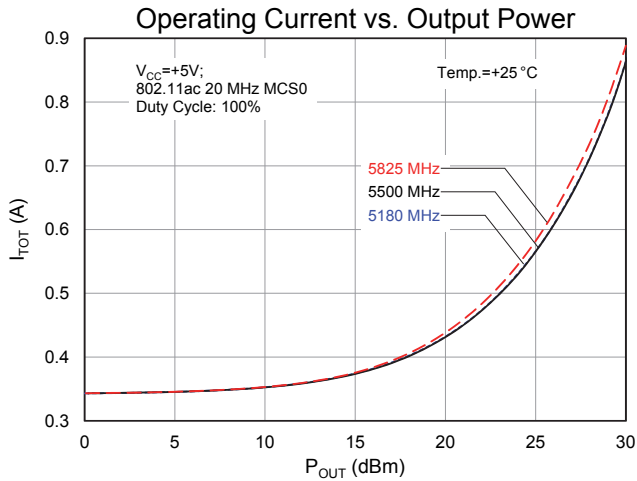
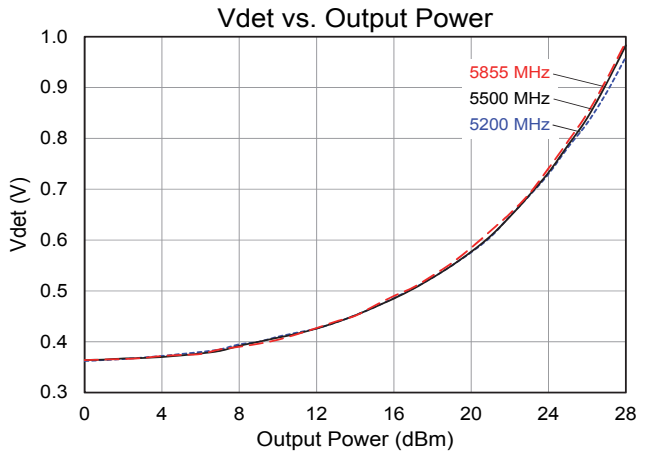
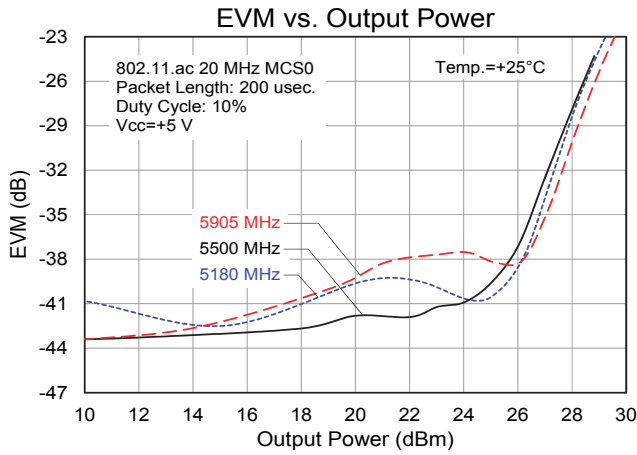

Performance Plots Vcc = +4.2 V

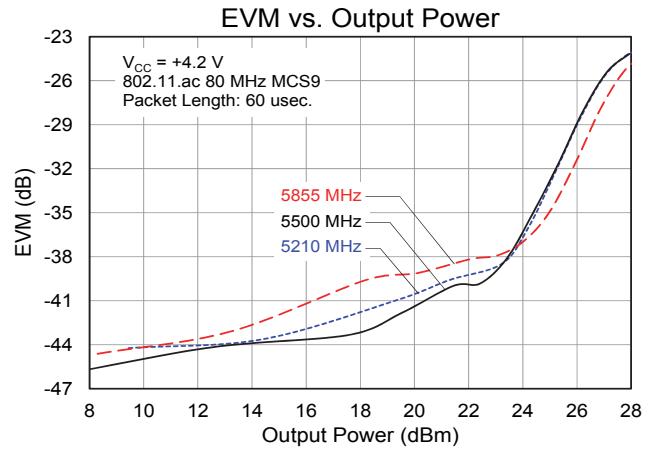
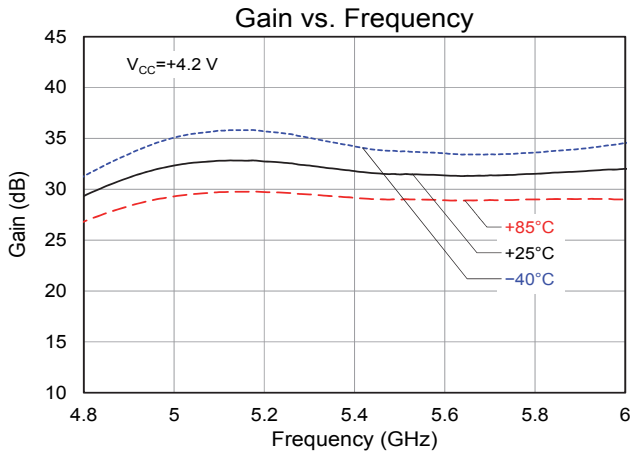

Performance Plots Vcc = +3.3 V

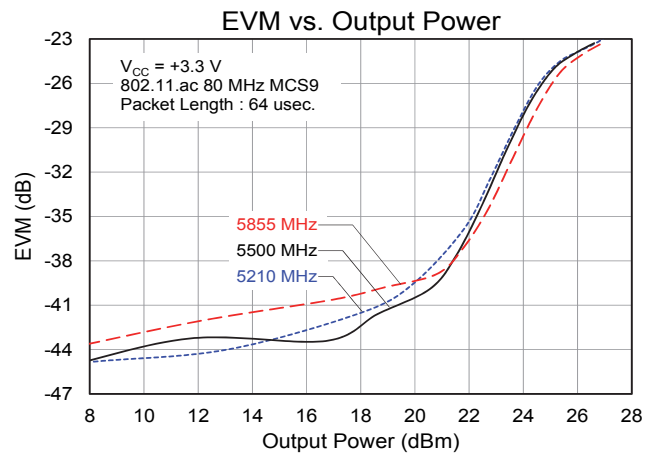
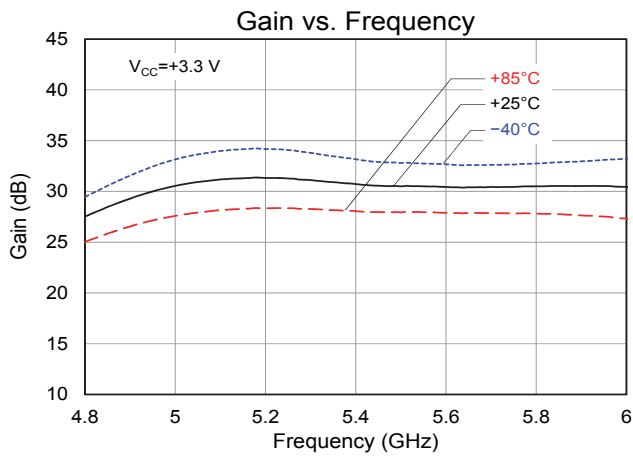

Application Circuit

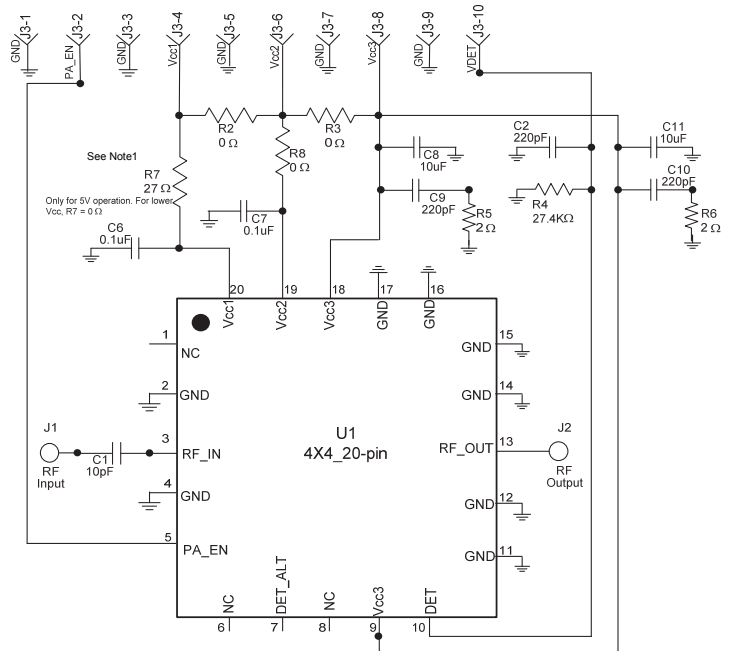
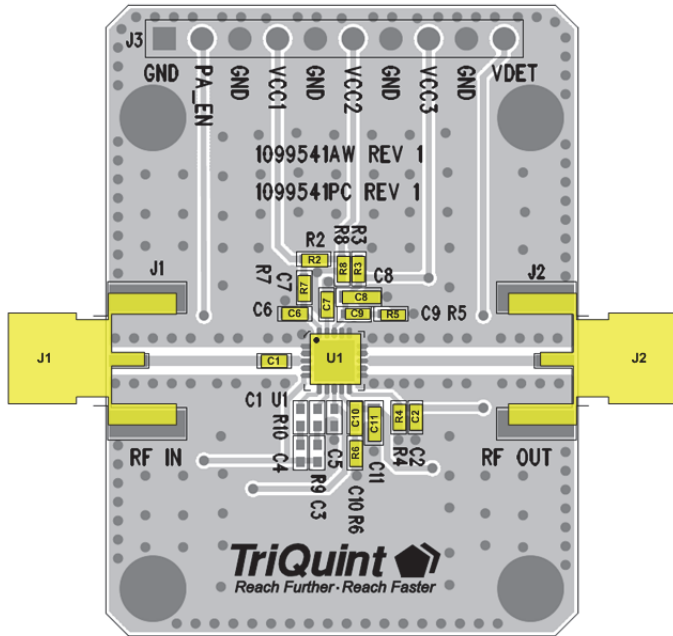

Bill of Material

Ref Des	Value	Description	Manuf.	Part Number
n/a	n/a	Printed Circuit Board		1099541
U1	n/a	High Power WLAN 5GHz PA	TriQuint	TQP5525
R2, R8, R3	0 Ω	Resistor, Chip, 04023, 5%	various	
C1	10 pF	Capacitor, Chip, 0402, 5%	various	
C6, C7	0.1 uF	Capacitor, Chip, 0402, 10%	various	
C8, C11	10 uF	Capacitor, Chip, 0402, 10%	various	
C9, C10, C2	220 pF	Capacitor, Chip, 0402, 10%	various	
R7 ⁽¹⁾	0 to 27 Ω	Resistor, Chip, 0402, 5%, 1/10W	various	
R5, R6 ⁽²⁾	2 Ω	Resistor, Chip, 0402, 5%, 1/16W	various	
R4	27.4 KΩ	Resistor, Chip, 0402, 5%, 1/16W	various	

Notes:

1. For Vcc1>+4.5V, value of R7 may be varied between 0 and 27 Ohms for EVM floor optimization.
2. R5 and R6 are de-Q resistors.

Pin Configuration and Description

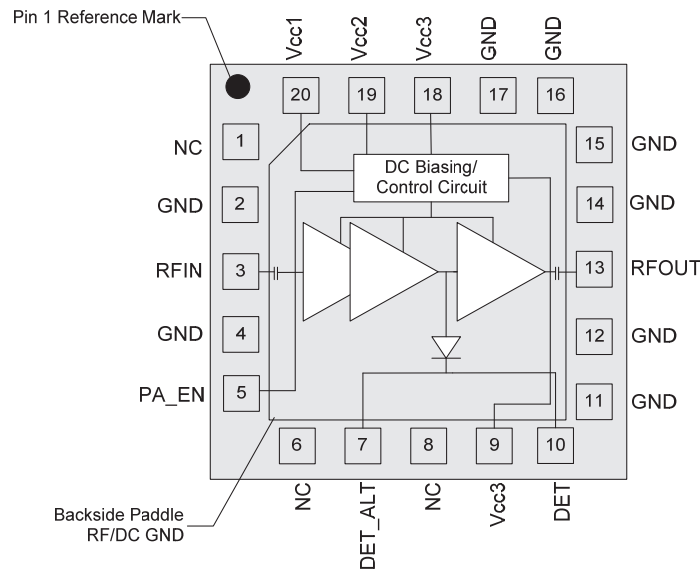

Pin No.	Label	Description
1	NC	No internal connection. This pin can be grounded or N/C on PCB.
2	GND	Ground
3	RF_IN	RF Input
4	GND	Ground
5	PA_EN	PA Enable
6	NC	No internal connection. This pin can be grounded or N/C on PCB.
7	DET_ALT	Alternate Detector Output
8	NC	No internal connection. This pin can be grounded or N/C on PCB.
9	VCC3	Supply voltage for third stage PA
10	DET	Detector Output
11	GND	Ground
12	GND	Ground
13	RF_OUT	RF Output
14	GND	Ground
15	GND	Ground
16	GND	Ground
17	GND	Ground
18	VCC3	Supply voltage for third stage PA
19	VCC2	Supply voltage for second stage PA
20	VCC1	Supply voltage for first stage PA
Backside Pad	RF/DC GND	RF/DC ground. Use recommended via pattern to minimize inductance and thermal resistance. See PCB Mounting Pattern for suggested footprint.

Package Marking and Dimensions

Marking: Product Identifier - TQ5525
Date Code - YYWW (Year, workweek)
Lot Code - AaXXXX

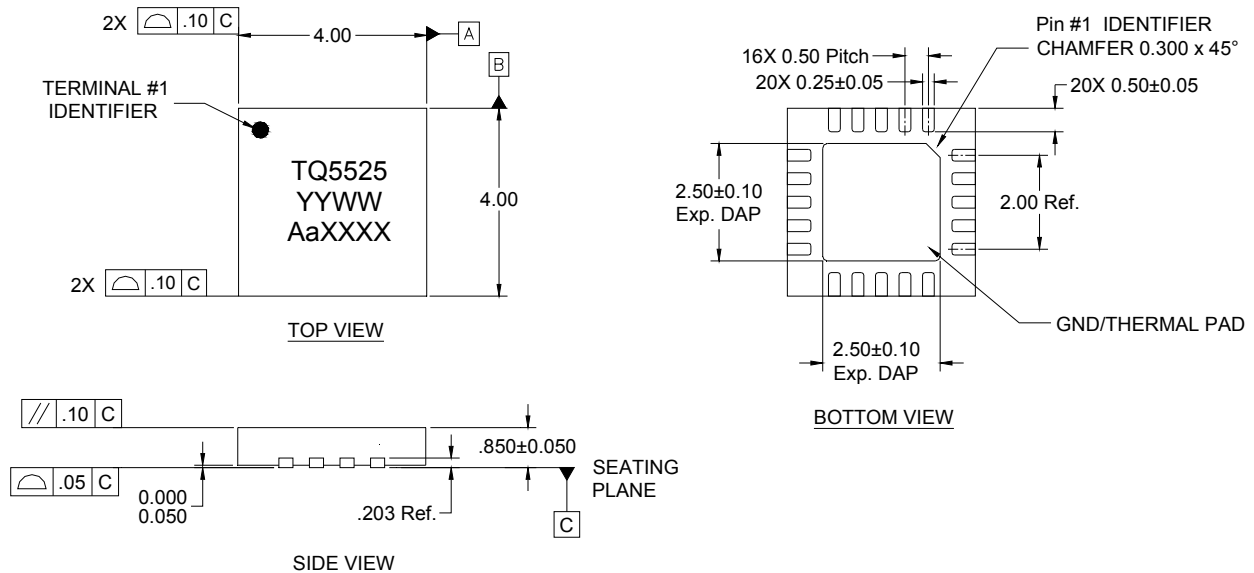

- Notes:
1. All dimensions are in millimeters.
 2. Contact plating: NiPdAu.

PCB Mounting Pattern

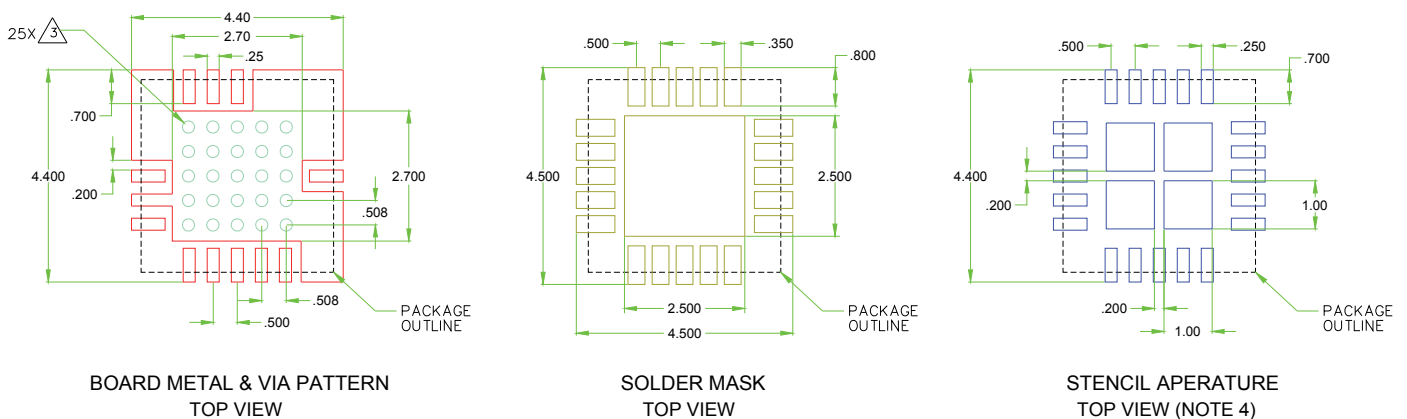

- Notes:
1. All dimensions are in millimeters. Angles are in degrees.
 2. Use 1 oz. copper minimum for top and bottom layer metal.
 3. Vias are required under the backside paddle of this device for proper RF/DC grounding and thermal dissipation. We recommend a 0.35mm (#80/.0135") diameter bit for drilling via holes and a final plated thru diameter of 0.25 mm (0.10").
 4. Ensure good package backside paddle solder attach for reliable operation and best electrical performance.

Handling Precautions

Parameter	Rating	Standard
ESD – Human Body Model (HBM)	Class 1C	ESDA / JEDEC JS-001-2012
ESD – Charged Device Model (CDM)	Class C3	JEDEC JESD22-C101F
MSL – Moisture Sensitivity Level	Level 1	IPC/JEDEC J-STD-020



Caution!
ESD-Sensitive Device

Solderability

Compatible with both lead-free (260°C max. reflow temp.) and tin/lead (245°C max. reflow temp.) soldering processes. Solder profiles available upon request.

Contact plating: NiPdAu

RoHS Compliance

This part is compliant with 2011/65/EU RoHS directive (Restrictions on the Use of Certain Hazardous Substances in Electrical and Electronic Equipment) as amended by Directive 2015/863/EU.

This product also has the following attributes:

- Lead Free
- Halogen Free (Chlorine, Bromine)
- Antimony Free
- TBBP-A (C₁₅H₁₂Br₄O₂) Free
- PFOS Free
- SVHC Free



Contact Information

For the latest specifications, additional product information, worldwide sales and distribution locations:

Web: www.qorvo.com

Tel: 1-844-890-8163

Email: customer.support@qorvo.com

Important Notice

The information contained herein is believed to be reliable; however, Qorvo makes no warranties regarding the information contained herein and assumes no responsibility or liability whatsoever for the use of the information contained herein. All information contained herein is subject to change without notice. Customers should obtain and verify the latest relevant information before placing orders for Qorvo products. The information contained herein or any use of such information does not grant, explicitly or implicitly, to any party any patent rights, licenses, or any other intellectual property rights, whether with regard to such information itself or anything described by such information. **THIS INFORMATION DOES NOT CONSTITUTE A WARRANTY WITH RESPECT TO THE PRODUCTS DESCRIBED HEREIN, AND QORVO HEREBY DISCLAIMS ANY AND ALL WARRANTIES WITH RESPECT TO SUCH PRODUCTS WHETHER EXPRESS OR IMPLIED BY LAW, COURSE OF DEALING, COURSE OF PERFORMANCE, USAGE OF TRADE OR OTHERWISE, INCLUDING THE IMPLIED WARRANTIES OF MERCHANTABILITY AND FITNESS FOR A PARTICULAR PURPOSE.**

Without limiting the generality of the foregoing, Qorvo products are not warranted or authorized for use as critical components in medical, life-saving, or life-sustaining applications, or other applications where a failure would reasonably be expected to cause severe personal injury or death.

Copyright 2016 © Qorvo, Inc. | Qorvo is a registered trademark of Qorvo, Inc.