

SOT-23 Plastic-Encapsulate MOSFET

P -Channel MOSFET

Product Summary

$V_{(BR)DSS}$	$R_{DS(on)MAX}$	I_D
-12V	45mΩ@-4.5V	-4.1A
	60mΩ@-2.5V	
	90mΩ@-1.8V	

Features

- TrenchFET Power MOSFET

Applications

- Load Switch for Portable Devices
- DC/DC Converter

Marking

- S5

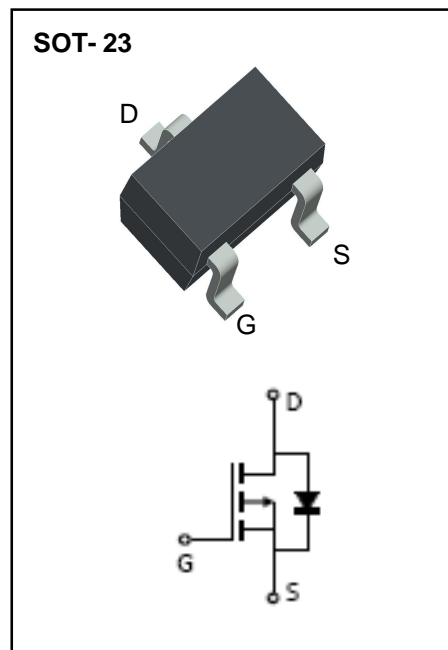

Limiting Values (Absolute Maximum Rating)

Parameter	Symbol	Value	Unit
Drain-Source Voltage	V_{DS}	-12	V
Gate-Source Voltage	V_{GS}	±8	
Continuous Drain Current	I_D	-4.1	A
Continuous Source-Drain Diode Current	I_S	-0.8	
Maximum Power Dissipation	P_D	0.35	W
Thermal Resistance from Junction to Ambient($t \leq 10s$)	$R_{\theta JA}$	357	°C/W
Junction Temperature	T_J	150	°C
Storage Temperature	T_{STG}	-50 ~ +150	

Electrical Characteristics (T_A=25°C unless otherwise noted)

Parameter	Symbol	Test Condition	Min	Typ	Max	Units
Static						
Drain-source breakdown voltage	V _{(BR)DSS}	V _{GS} = 0V, I _D = -250μA	-12			V
Gate-source threshold voltage	V _{GS(th)}	V _{DS} = V _{GS} , I _D = -250μA	-0.5		-0.9	
Gate-source leakage	I _{GSS}	V _{DS} = 0V, V _{GS} = ±8V			±100	nA
Zero gate voltage drain current	I _{DSS}	V _{DS} = -8V, V _{GS} = 0V			-1	μA
Drain-source on-state resistance ^e	R _{DS(on)}	V _{GS} = -4.5V, I _D = -3.5A		30	45	mΩ
		V _{GS} = -2.5V, I _D = -3A		40	60	
		V _{GS} = -1.8V, I _D = -2.0A		60	90	
Forward transconductance ^a	g _{fs}	V _{DS} = -5V, I _D = -4.1A	6			S
Dynamic						
Input capacitance ^{b,c}	C _{iss}	V _{DS} = -4V, V _{GS} = 0V, f = 1MHz		740		pF
Output capacitance ^{b,c}	C _{oss}			290		
Reverse transfer capacitance ^{b,c}	C _{rss}			190		
Total gate charge ^b	Q _g	V _{DS} = -4V, V _{GS} = -4.5V, I _D = -4.1A		7.8	15	nC
		V _{DS} = -4V, V _{GS} = -2.5V, I _D = -4.1A		4.5	9	
Gate-source charge ^b	Q _{gs}	V _{DS} = -4V, V _{GS} = -2.5V, I _D = -4.1A		1.2		
Gate-drain charge ^b	Q _{gd}			1.6		
Gate resistance ^{b,c}	R _g	f = 1MHz	1.4	7	14	Ω
Turn-on delay time ^{b,c}	t _{d(on)}	V _{DD} = -4V, R _L = 1.2Ω, I _D ≈ -3.3A, V _{GEN} = -4.5V, R _g = 1Ω		13	20	ns
Rise time ^{b,c}	t _r			35	53	
Turn-off Delay time ^{b,c}	t _{d(off)}			32	48	
Fall time ^{b,c}	t _f			10	20	
Turn-on delay time ^{b,c}	t _{d(on)}	V _{DD} = -4V, R _L = 1.2Ω, I _D ≈ -3.3A, V _{GEN} = -8V, R _g = 1Ω		5	10	
Rise time ^{b,c}	t _r			11	17	
Turn-off delay time ^{b,c}	t _{d(off)}			22	33	
Fall time ^{b,c}	t _f			16	24	
Drain-source body diode characteristics						
Continuous source-drain diode current	I _S	T _C = 25°C			-1.4	A
Pulse diode forward current ^a	I _{SM}				-10	
Body diode voltage	V _{SD}	I _F = -3.3A			-1.2	V

Note :

- Pulse Test ; Pulse Width ≤300μs, Duty Cycle ≤2%.
- Guaranteed by design, not subject to production testing.
- These parameters have no way to verify.

Typical Characteristics

Output Characteristics

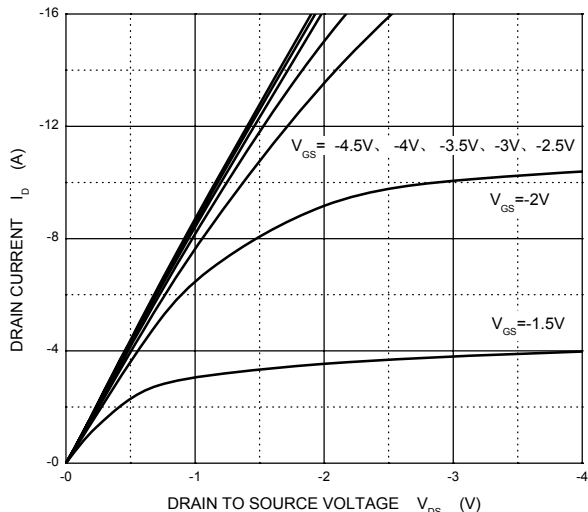

Transfer Characteristics

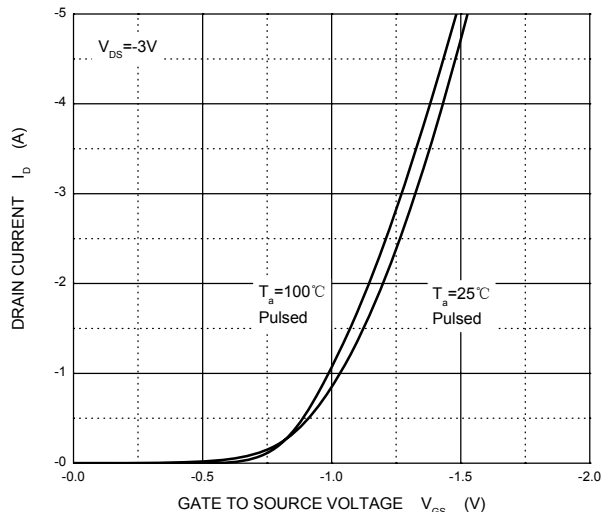

$R_{DS(ON)}$ — I_D

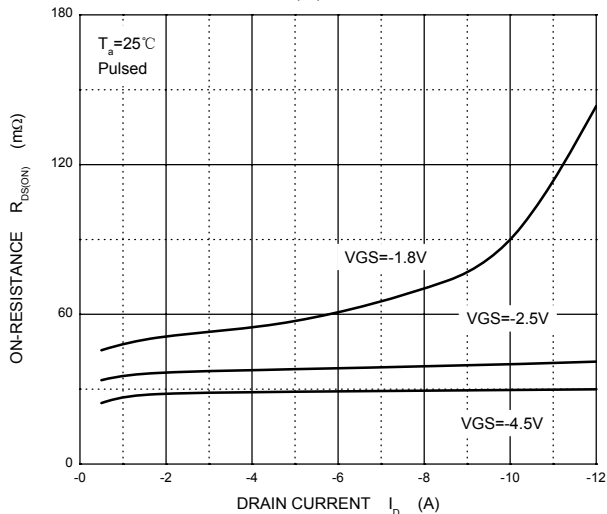

$R_{DS(ON)}$ — V_{GS}

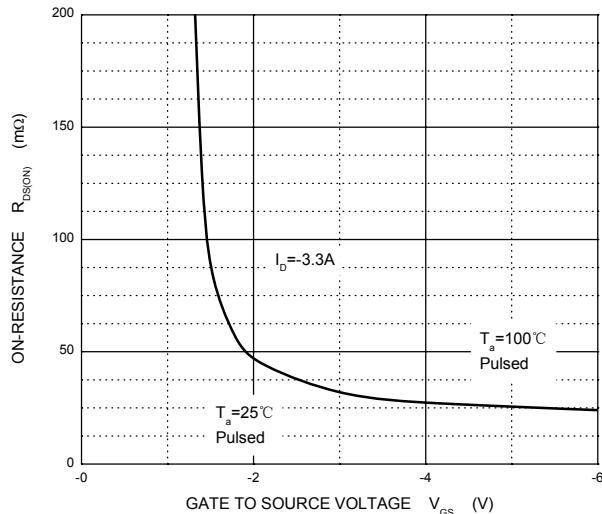

I_S — V_{SD}

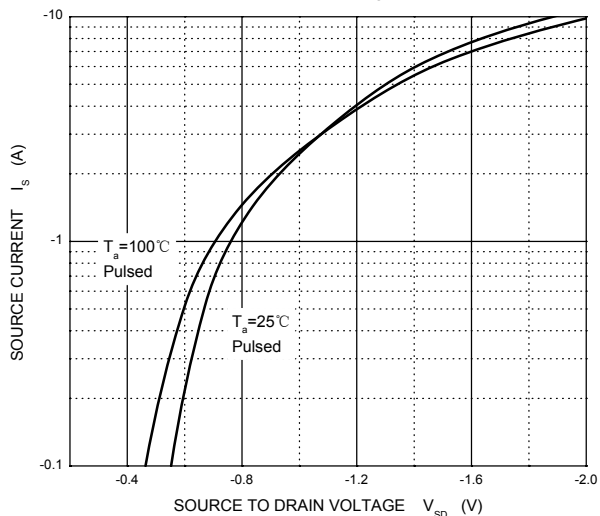

Threshold Voltage

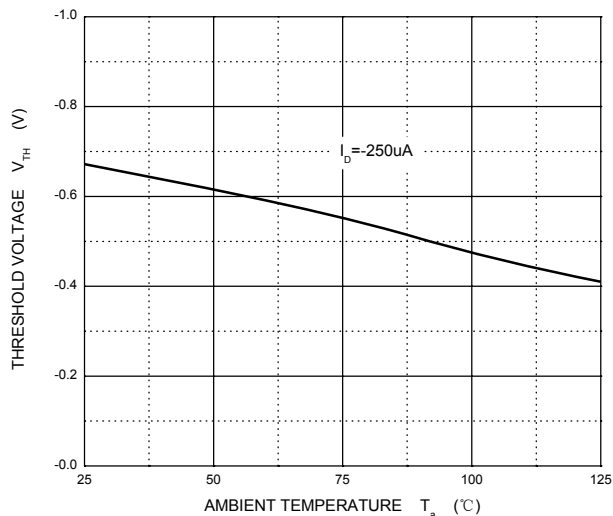

SOT-23 Package Outline Dimensions

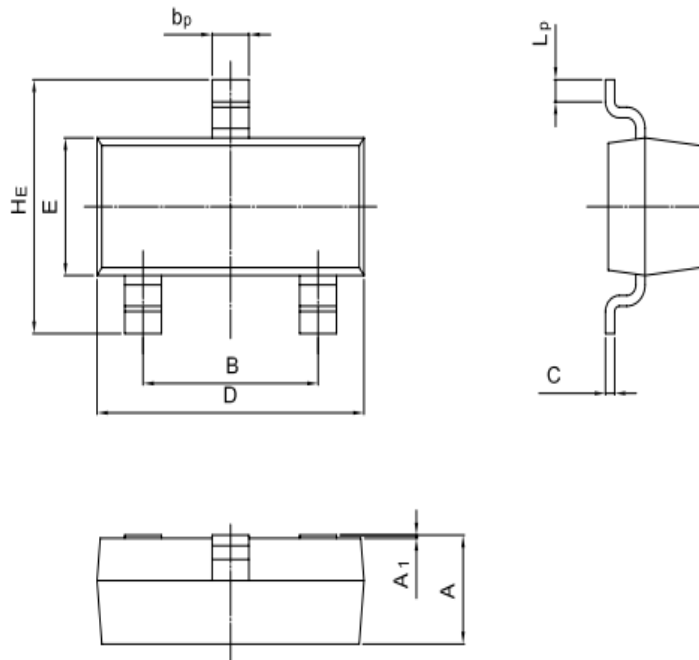

UNIT	A	B	bp	C	D	E	HE	A1	Lp
mm	1.40 0.95	2.04 1.78	0.50 0.35	0.19 0.08	3.10 2.70	1.65 1.20	3.00 2.20	0.100 0.013	0.50 0.20

SOT-23 Suggested Pad Layout

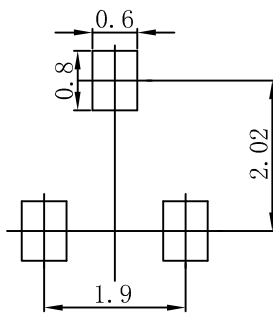

Note:

1. Controlling dimension: in millimeters.
2. General tolerance: $\pm 0.05\text{mm}$.
3. The pad layout is for reference purposes only.

NOTICE

JSJD reserve the right to make modifications, enhancements, improvements, corrections or other changes without further notice to any product herein. JSJD does not assume any liability arising out of the application or use of any product described herein.

Reel Taping Specifications For Surface Mount Devices-SOT-23

SOT-23 Embossed Carrier Tape

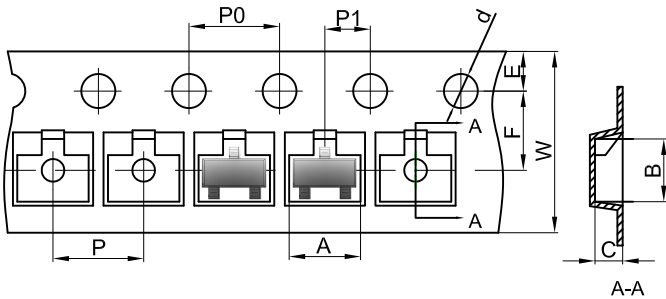

Packaging Description:

SOT-23 parts are shipped in tape. The carrier tape is made from a dissipative (carbon filled) polycarbonate resin. The cover tape is a multilayer film (Heat Activated Adhesive in nature) primarily composed of polyester film, adhesive layer, sealant, and anti-static sprayed agent. These reeled parts in standard option are shipped with 3,000 units per 7" or 17.8cm diameter reel. The reels are clear in color and is made of polystyrene plastic (anti-static coated).

Dimensions are in millimeter

Pkg type	A	B	C	d	E	F	P0	P	P1	W
SOT-23	3.15	2.77	1.22	Ø1.50	1.75	3.50	4.00	4.00	2.00	8.00

SOT-23 Tape Leader and Trailer

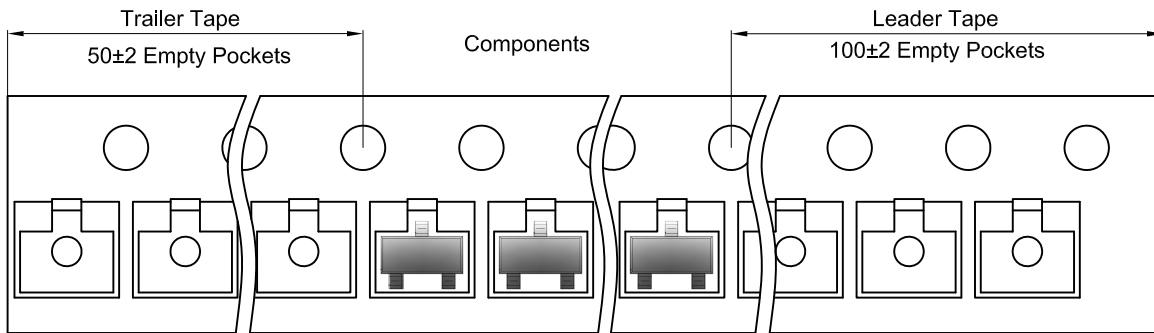

SOT-23 Reel

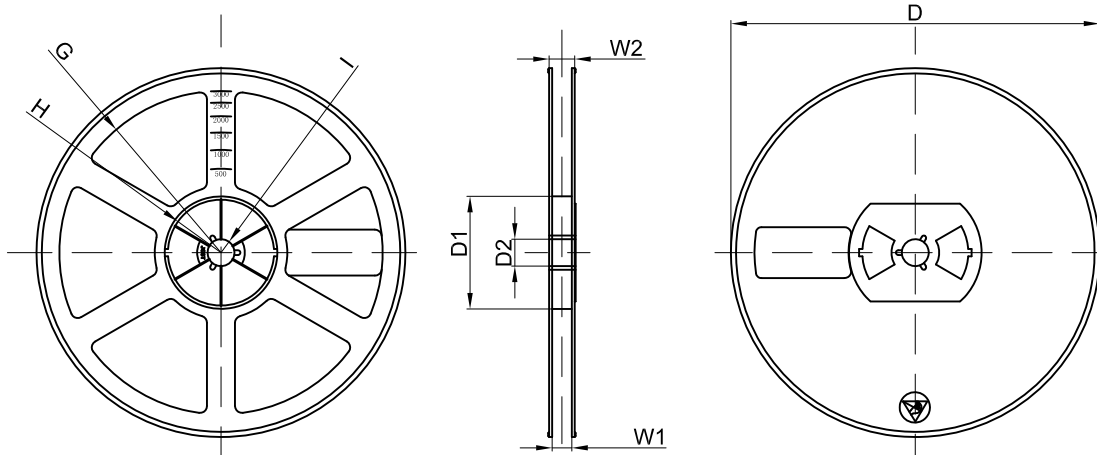

Dimensions are in millimeter

Reel Option	D	D1	D2	G	H	I	W1	W2
7"Dia	Ø178.00	54.40	13.00	R78.00	R25.60	R6.50	9.50	12.30

REEL	Reel Size	Box	Box Size(mm)	Carton	Carton Size(mm)	G.W.(kg)
3000 pcs	7 inch	45,000 pcs	203×203×195	180,000 pcs	438×438×230	