

DIO1553

Dual SPST Depletion Audio Switch with Negative Swing

Features

- Dual SPST Depletion Switch
- Normally Closed when $V_{CC} < 0.2V$
- Switches Configurable through Select Pins
- V_{SW} : -1.5V to 1.5V
- R_{ON} : 0.35 Ω (Typical)
- $R_{FLAT} < 0.01\Omega$ (Typical)
- THD+N: -103dB (Typical)
- OIRR: -88dB (Typical)

Applications

- Smart Phones
- Tablets, Ultra Books

Descriptions

The DIO1553 is a high-performance dual single-pole single-throw (SPST x 2) audio switch. The Depletion technology allows the device to conduct signals when there is no V_{CC} available and to isolate signals when V_{CC} is present. During signal conduction, the Depletion gate control allows the DIO1553 to achieve excellent THD+N performance while consuming minimal power.

Typical Applications

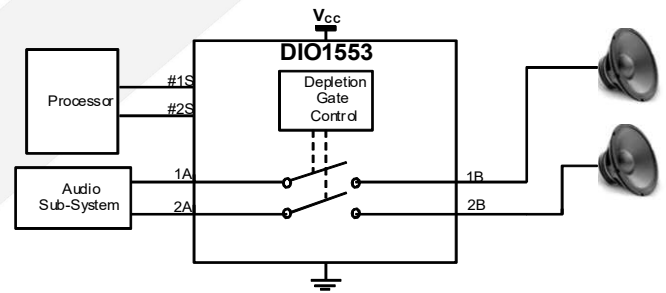
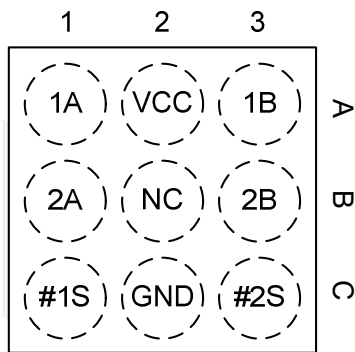

Figure 1. Application Block Diagram

Ordering Information

Order Part Number	Top Marking		T_A	Package	
DIO1553WL9	1553	Green	-40 to 85°C	WLCSP-9	Tape & Reel, 3000

Pin Configuration



WLCSP-9

Figure 2. Pin Assignment (Top View)

Pin Definitions

Pin #	Name	Type	Description
A1	1A	Depletion I/O	A-Port of Switch 1 (Normally Closed)
A3	1B	Depletion I/O	B-Port of Switch 1 (Normally Closed)
C1	#1S	Control	Select to Enable/Disable SW1 (Enable LOW)
A2	VCC	Power Supply / Control	Power Supply Input
B2	NC	No Connect	Do Not Connect
C2	GND	Ground	Ground
B1	2A	Depletion I/O	A-Port of Switch 2 (Normally Closed)
B3	2B	Depletion I/O	B-Port of Switch 2 (Normally Closed)
C3	#2S	Control	Select to Enable/Disable SW2 (Enable LOW)

Truth Table (Table 1)

V _{cc}	#1S	#2S	Switch 1	Switch 2
LOW	X	X	ON	ON
HIGH	HIGH	HIGH	OFF	OFF
HIGH	LOW	HIGH	ON	OFF
HIGH	HIGH	LOW	OFF	ON



DIO1553

Dual SPST Depletion Audio Switch with Negative Swing

Absolute maximum Rating

Stresses exceeding the absolute maximum ratings may damage the device. The device may not function or be operable above the recommended operating conditions and stressing the parts to these levels is not recommended. In addition, extended exposure to stresses above the recommended operating conditions may affect device reliability. The absolute maximum ratings are stress ratings only.

Symbol	Parameter		Min.	Max.	Unit
V _{CC}	Supply/Control Voltage		-0.5	4.3	V
V _{CNTRL}	Select Input Voltage	#1S, #2S	-0.5	4.3	V
V _{SW(ON)}	DC Switch I/O Voltage (Switch Conducting)	1A, 1B, 2A, 2B	-2	2	V
V _{SW(OFF)}	DC Switch I/O Voltage (Switch Isolated)	1A, 1B, 2A, 2B	-1.8	V _{CC}	V
I _{SW}	Switch I/O Current	V _{CC} =0 V (Switch Conducting)		350	mA
I _{SWPEAK}	Peak Switch Current	Pulsed at 1 ms Duration, <10% Duty Cycle		500	mA
ESD	Human Body Model, ANSI/ESDA/JEDEC JS-001-2012		6.5		kV
T _A	Absolute Maximum Operating Temperature		-40	85	°C
θ _{JA}	Thermal Resistance, Junction-to-Ambient	2S2P JEDEC std. PCB		97	°C/W
T _{STG}	Storage Temperature		-65	150	°C

Recommended Operating Conditions

The Recommended Operating Conditions table defines the conditions for actual device operation. Recommended operating conditions are specified to ensure optimal performance to the datasheet specifications. Fairchild does not recommend exceeding these ratings or designing to Absolute Maximum Ratings.

Symbol	Parameter		Min.	Max.	Unit
V _{CC(ON)}	Supply Voltage with Depletion Switch Conducting (1A=1B; 2A=2B)		0	0.2	V
V _{CC(OFF)}	Supply Voltage with Depletion Switch Isolated (1A≠1B; 2A≠2B);		1.6	3	V
V _{SW(ON)}	DC Switch I/O Voltage	Switch Conducting	-1.5	1.5	V
V _{SW(OFF)}	DC Switch I/O Voltage	Switch Isolated	-1.5	1.5	V
V _{CNTRL}	Select Input Voltage	#1S, #2S	0	3	V



DIO1553

Dual SPST Depletion Audio Switch with Negative Swing

DC Electrical Characteristics

Unless otherwise specified, typical values are for $T_A=25^{\circ}\text{C}$.

Symbol	Parameter	Condition	$T_A=-40^{\circ}\text{C}$ to 85°C				
			V_{CC} (V)	Min.	Typ.	Max.	Unit
$V_{CC(HYS)}$	Supply Voltage Hysteresis				180		mV
I_{ON}	Switch ON Leakage Current	nA=-0.5V, 0.5V, 1.5V, -1.5V, nB=Float, #1S=#2S=Float	0		0.1		μA
I_{OFF}	Switch OFF Leakage Current	nA=-0.5V, 0.5V, 1.5V, -1.5V, nB=GND, #1S=#2S= V_{CC}	1.8		0.5		μA
I_{CCT}	Increase in ICC for each Select Pin	#1S= V_{CC} , #2S=1.2V,	3		7		μA
		#1S=1.2V, #2S= V_{CC}					
R_{ON}	Switch On Resistance	$I_{SW}=100\text{mA}$, $V_{SW}=-1.5\text{V}$ to 1.5V	0		0.35		Ω
ΔR_{ON}	Switch On Resistance Difference, Channel to Channel	$I_{SW}=100\text{mA}$, $V_{SW}=-1.5\text{V}$ to 1.5V	0		0.01		Ω
$R_{FLAT(ON)}$	On Resistance Flatness	$I_{SW}=100\text{mA}$, $V_{SW}=-1.5\text{V}$ to 1.5V	0		0.01		Ω
R_{PD}	V_{CC} Pull-Down Resistance		<0.2		1.5		M Ω
R_{PU}	Select Pull-Up Resistance		<0.2		3		M Ω
I_{CC}	Quiescent Supply Current	#1S=#2S=0V or Float	Switch Isolated	1.5 – 3.0	50		μA
			Switch Conducting	0.2	0.2		
V_{IH}	Select Pin Input High Voltage		1.5 – 3.0	1.2			V
V_{IL}	Select Pin Input Low Voltage		1.5 – 3.0			0.5	V





DIO1553

Dual SPST Depletion Audio Switch with Negative Swing

AC Electrical Characteristics

Unless otherwise specified, typical values are for $T_A=25^{\circ}\text{C}$.

Symbol	Parameter	Condition		$T_A=-40^{\circ}\text{C}$ to 85°C				
				V_{CC} (V)	Min.	Typ.	Max.	Unit
t_{ON}	Turn-On Time V_{CC} to Output	$R_L=32\Omega$, $C_L=10\text{pF}$	$V_{SW}=1.5\text{ V}$	1.8 → 0		1		μs
		#nS=Float, Figure 3	$V_{SW}=-1.5\text{ V}$	1.8 → 0		1		
t_{OFF}	Turn-Off Time V_{CC} to Output	$R_L=32\Omega$, $C_L=10\text{pF}$	$V_{SW}=1.5\text{ V}$	0 → 1.8		130		μs
		#nS=Float, Figure 3	$V_{SW}=-1.5\text{ V}$	0 → 1.8		170		
t_{ONS}	Turn-On Time Select Pin	$R_L=32\Omega$, $C_L=10\text{pF}$	$V_{SW}=1.5\text{ V}$	1.8		180		μs
		#nS= $V_{CC} \rightarrow 0$, Figure 4	$V_{SW}=-1.5\text{ V}$	1.8		180		
t_{OFFS}	Turn-Off Time Select Pin	$R_L=32\Omega$, $C_L=10\text{pF}$	$V_{SW}=1.5\text{ V}$	1.8		55		μs
		#nS= $0 \rightarrow V_{CC}$, Figure 4	$V_{SW}=-1.5\text{ V}$	1.8		100		
BW	-3 dB Bandwidth	$V_{SW}=600\text{mVp-p}$, $R_L=50\Omega$; $C_L=5\text{pF}$		0		340		MHz
THD+N	Total Harmonic Distortion+Noise	$V_{SW}=1V_{RMS}$, $R_L=32\Omega$, $f=1\text{kHz}$	Non A-weighted	0		-103		dB
			A-weighted			-107		dB
OIRR	Port Off Isolation	$V_{SW}=0.707V_{RMS}$, $R_L=32\Omega$, $f=20\text{Hz}$ to 100kHz , Figure 5		1.8	-70	-88		dB
X_{TALK}	Cross Talk	$V_{SW}=1V_{RMS}$, $f=20\text{kHz}$, $R_L=32\Omega$		1.8		-100		dB
		$V_{SW}=1V_{RMS}$, $f=100\text{kHz}$, $R_L=32\Omega$				-75		
PSRR	Power Supply Rejection Ratio	Switch Isolating, $V_{Ripple}=V_{CC}+300\text{ mVp-p}$, $R_L=32\Omega$	217Hz	1.8		-80		dB
			1kHz			-77		
			20kHz			-73		

Capacitance

Unless otherwise specified, typical values are for $T_A=25^{\circ}\text{C}$.

Symbol	Parameter	Condition	$T_A=-40^{\circ}\text{C}$ to 85°C				
			V_{CC} (V)	Min.	Typ.	Max.	Unit
C_{ON}	On Capacitance	$V_{SW}=400\text{mVPP}$, $f=1\text{MHz}$,	0		21		pF
C_{OFF}	Off Capacitance	$V_{SW}=400\text{mVPP}$, $f=1\text{MHz}$, #1S=#2S= V_{CC}	1.8		25		pF
C_{CTRL}	Select Pin Capacitance	#nS=400mVPP, $f=1\text{MHz}$,	1.8		5		pF

Timing Diagrams

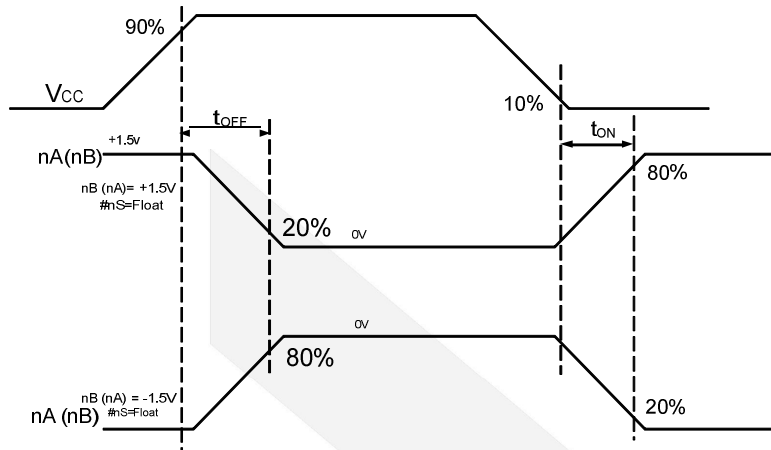

Figure 3. t_{ON}/t_{OFF} VCC to Output Timing

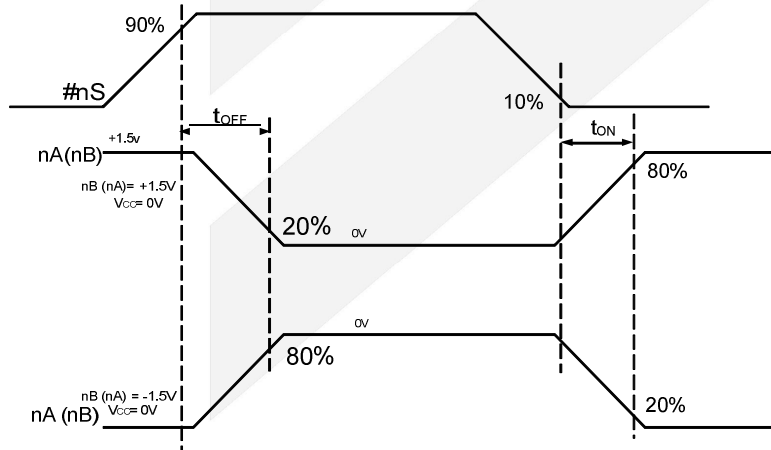
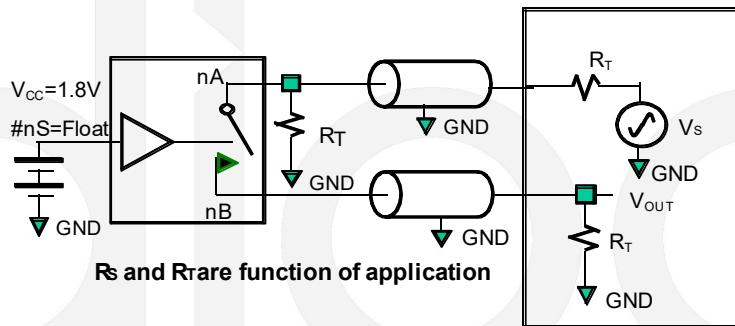

Figure 4. t_{ON}/t_{OFF} Select (#nS) to Output Timing



R_s and R_{rare} function of application

$$\text{OFF Isolation} = 20 \log(V_{OUT}/V_{IN})$$

Figure 5. OFF Isolation

Typical Performance Characteristics

ICC vs. VCC

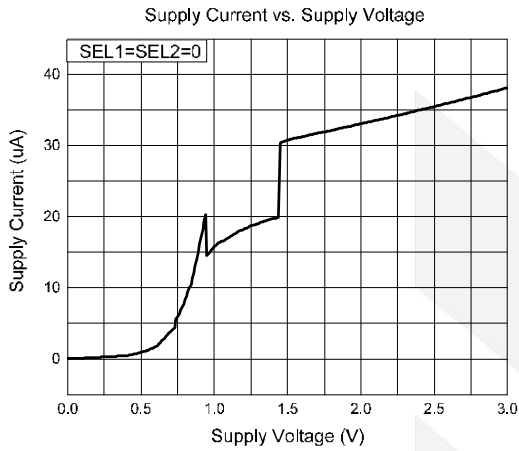

Ron

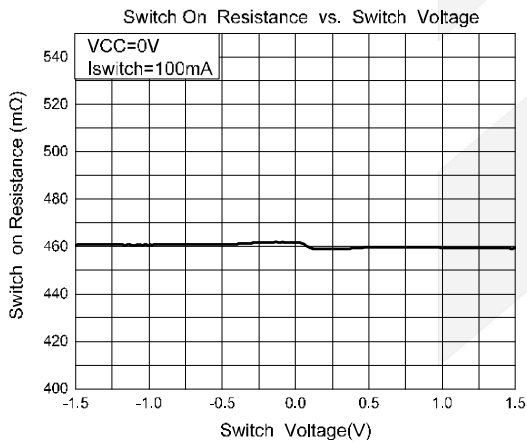

THD (A-Weighted)

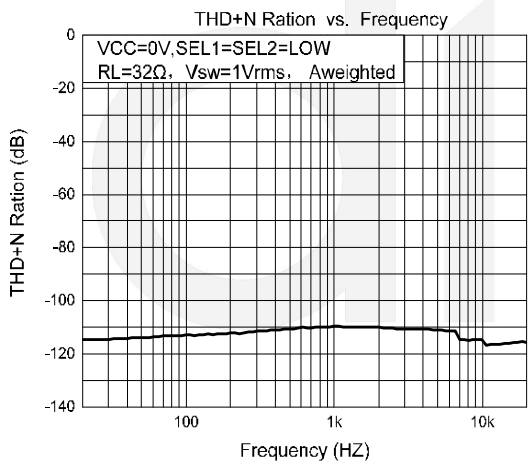

ICC VS. Temperature

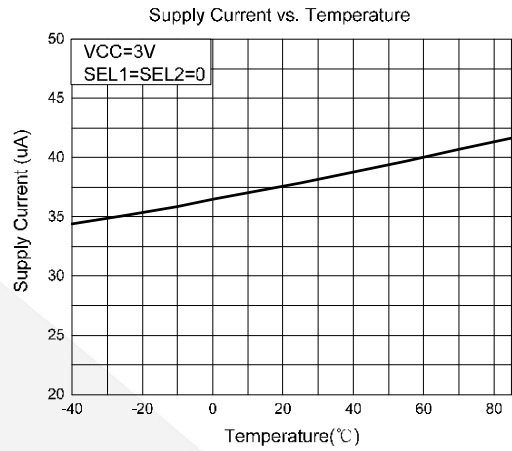

OIRR

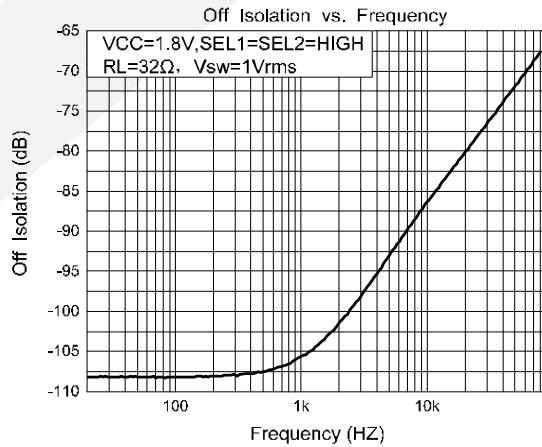

THD (Non A-Weighted)

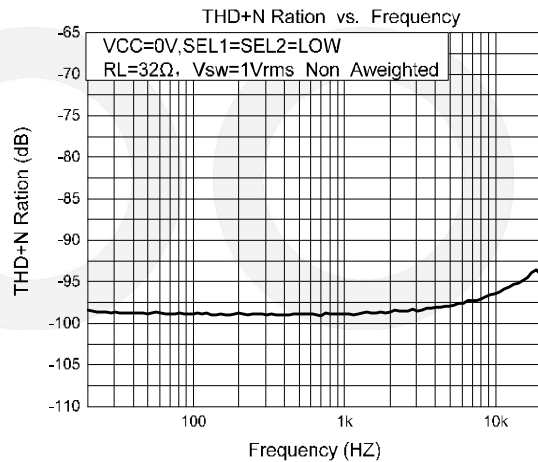

Physical Dimensions: WLCSP-9

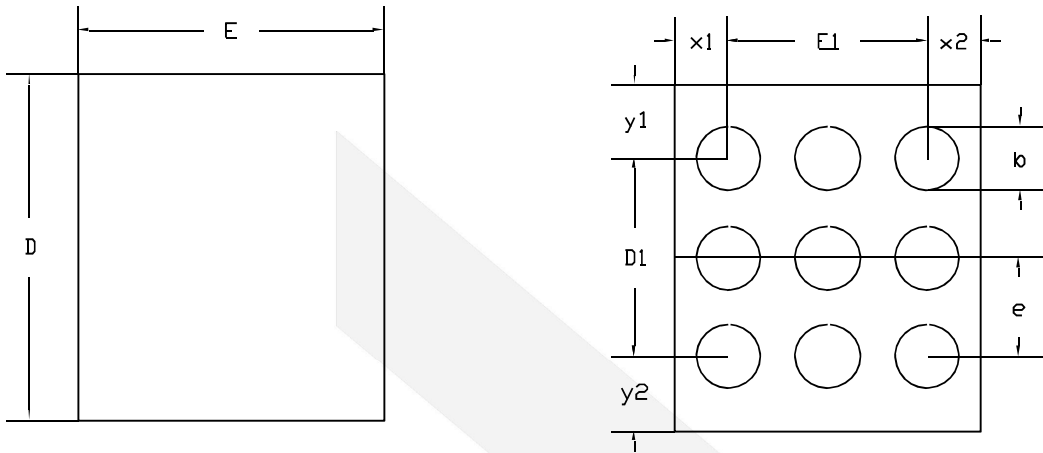

TOP VIEW
(MARK SIDE)

BOTTOM VIEW
(BALL SIDE)

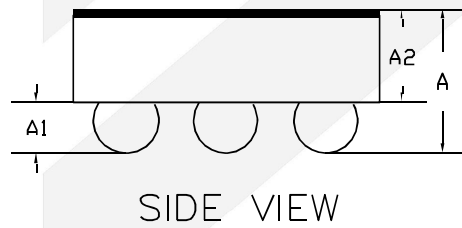

SIDE VIEW

NOTES:
ALL WAFER ORIENTATION NOTCH DOWN

Symbol	Min.	NOM.	Max.
A	0.541	0.581	0.624
A1	0.183	0.203	0.223
A2	0.358	0.378	0.398
D	1.365	1.385	1.405
D1	0.800BSC		
E	1.195	1.215	1.235
E1	0.800BSC		
b	0.23	0.26	0.29
e	0.400BSC		
x1	0.2075REF		
x2	0.2075REF		
y1	0.2925REF		
y2	0.2925REF		



DIO1553

Dual SPST Depletion Audio Switch with Negative Swing

CONTACT US

Dioo is a professional design and sales corporation for high-quality and performance analog semiconductors. The company focuses on industry markets, such as, cell phone, handheld products, laptop, and medical equipment and so on. Dioo's product families include analog signal processing and amplifying, LED drivers and charger IC. Go to <http://www.dioo.com> for a complete list of Dioo product families.

For additional product information, or full datasheet, please contact with our Sales Department or Representatives.

dioo