



# GBU10005 thru GBU1010

## 10.0 A Single-Phase Silicon Bridge Rectifier Rectifier Reverse Voltage 50 to 1000V

### Features

- Ideal for printed circuit board mounting
- This series is UL listed under the Recognized Component Index, file number E142814
- The plastic material used carries Underwriters Laboratory flammability recognition 94V-0
- Built-in printed circuit board stand-offs
- High case dielectric strength
- High temperature soldering guaranteed 260°C / 5 seconds at 5 lbs (2.3kg) tension

### Mechanical Data

Case: Reliable low cost construction utilizing molded plastic technique

Terminals: Plated leads solderable per MIL-STD-202, Method 208

Mounting Position: Any

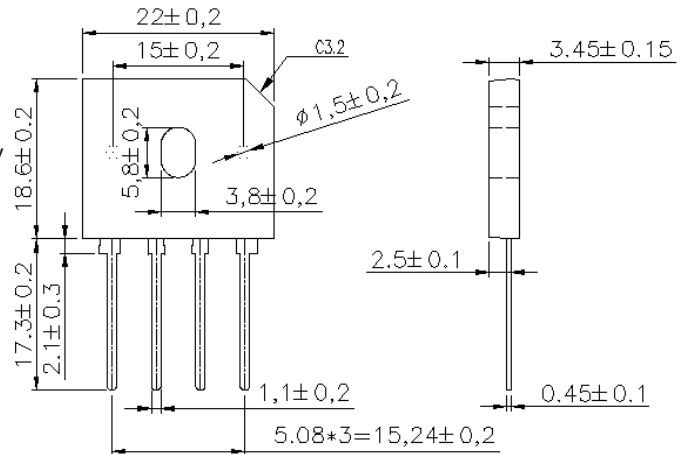

Dimensions in inches and (millimeters)

### Maximum Ratings & Thermal Characteristics

Rating at 25°C ambient temperature unless otherwise specified, Resistive or Inductive load, 60 Hz.  
For Capacitive load derate current by 20%.

Parameter	Symbol	GBU 10005	GBU 1001	GBU 1002	GBU 1004	GBU 1006	GBU 1008	GBU 1010	unit
Maximum repetitive peak reverse voltage	VRRM	50	100	200	400	600	800	1000	V
Maximum RMS bridge input voltage	VRMS	35	70	140	280	420	560	700	V
Maximum DC blocking voltage	VDC	50	100	200	400	600	800	1000	V
Maximum average forward rectified output current at TC=100°C (with heatsink)	IF(AV)	10.0							A
Peak forward surge current single sine-wave superimposed on rated load (JEDEC Method)	IFSM	200							A
Rating for fusing ( t<8.3ms)	I <sup>2</sup> t	166							A <sup>2</sup> sec
Operating junction and storage temperature range	TJ, TSTG	-55 to + 150							°C

### Electrical Characteristics

Rating at 25°C ambient temperature unless otherwise specified. Resistive or Inductive load, 60Hz.  
For Capacitive load derate by 20 %.

Parameter	Symbol	GBU 10005	GBU 1001	GBU 1002	GBU 1004	GBU 1006	GBU 1008	GBU 1010	Unit
Maximum instantaneous forward voltage drop per leg at 5.0A	VF	1.1							V
Maximum DC reverse current at rated TA =25°C DC blocking voltage per element TA =125°C	IR	10 500							μA

Notes: (1) Thermal resistance from Junction to Ambient on P.C. board mounting.

# Rating and Characteristic Curves ( $T_A=25^{\circ}\text{C}$ Unless otherwise noted )

## GBU10005 thru GBU1010

**Fig. 1 Derating Curve for Output Rectified Current**

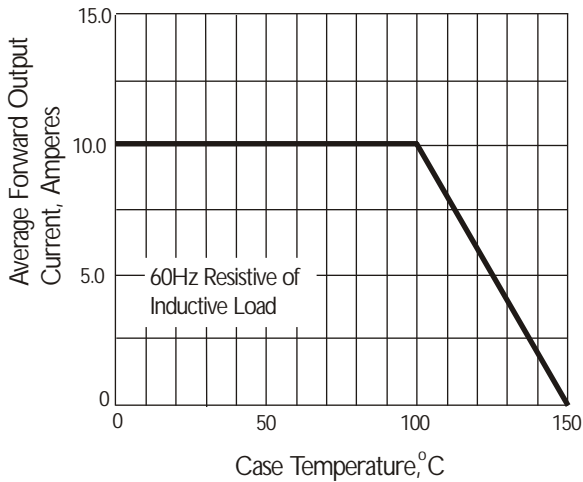

**Fig. 2 Maximum Non-repetitive Peak Forward Surge Current**

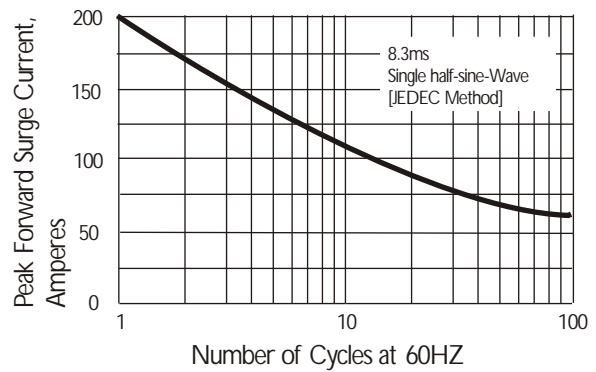

**Fig. 3 Typical Instantaneous Forward Characteristics**

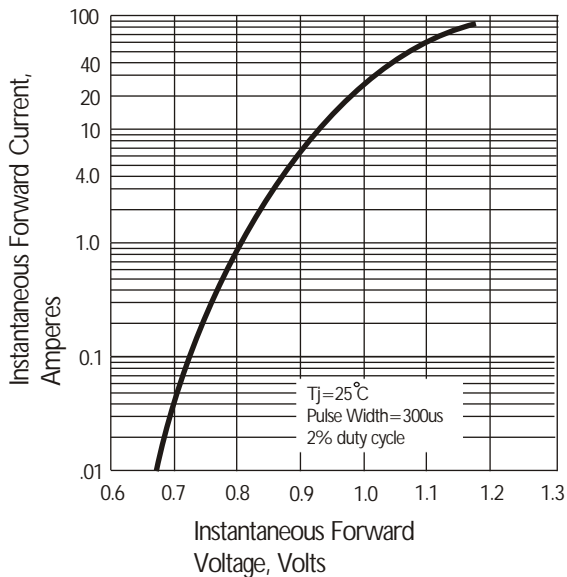

**Fig. 4 Typical Reverse Characteristics**

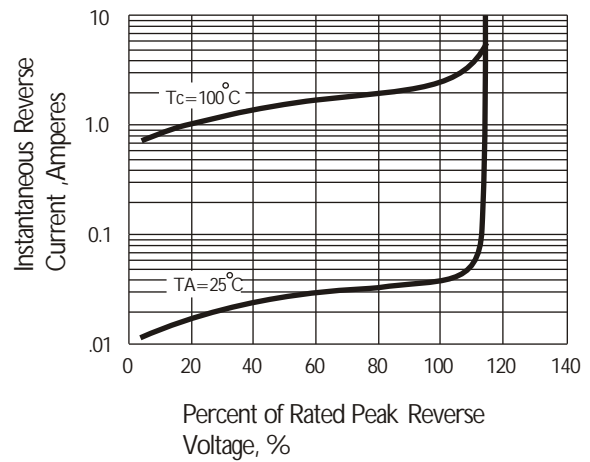

**Fig. 5 Typical Junction Capacitance**

