



ISO9001-2000 CERTIFIED

REV NO: A/0



产品承认书

SPECIFICATION FOR APPROVAL

CUSTOMER : 立创

PRODUCT NAME: 网络排阻 RA 0--2MΩ

RESISTANCE VALUE: 4.7KΩ ±2%

MONEC P/N: (example) RAA09472GFN

CUSTOMER P/N: _____

ISSUE DATE: 一月 23, 2019

APPROVED	PREPARED

CUSTOMER APPROVAL:

APPROVED	CHECKED

珠海鑫汇电子科技有限公司

ZHUHAI MONEC ELECTRONIC TECHNOLOGY CO.,LTD.

珠海市石花西路 203 号 5F(格力 2 号厂房 5 楼)

Add: NO.203,SHIHUA W.RD., ZHUHAI, CHINA P.C. 519020.

TEL : 0756-8877880

Http: www.Monec.com.cn

FAX : 0756-8877000

E-mail: sam@Monec.com.cn

1. Instruction

This sheet is the statement of the resistor network specification that our company productions can meet.

2. Construction & Dimensions

Unit: mm

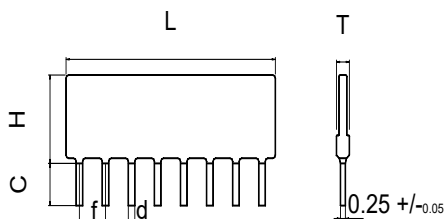

Style	L (max)	H max		T (max)	C ±0.60	d ±0.1	f ±0.20
		RA	RB				
4 pin	10.2						
5 pin	12.7						
6 pin	15.3						
7 pin	17.8						
8 pin	20.4						
9 pin	22.9	5.80	8.5	2.9	3.3	0.5	2.54
10 pin	25.4						
11 pin	28.0						
12 pin	30.5						
13 pin	33.1						
14 pin	35.6						

3. Circuit diagram

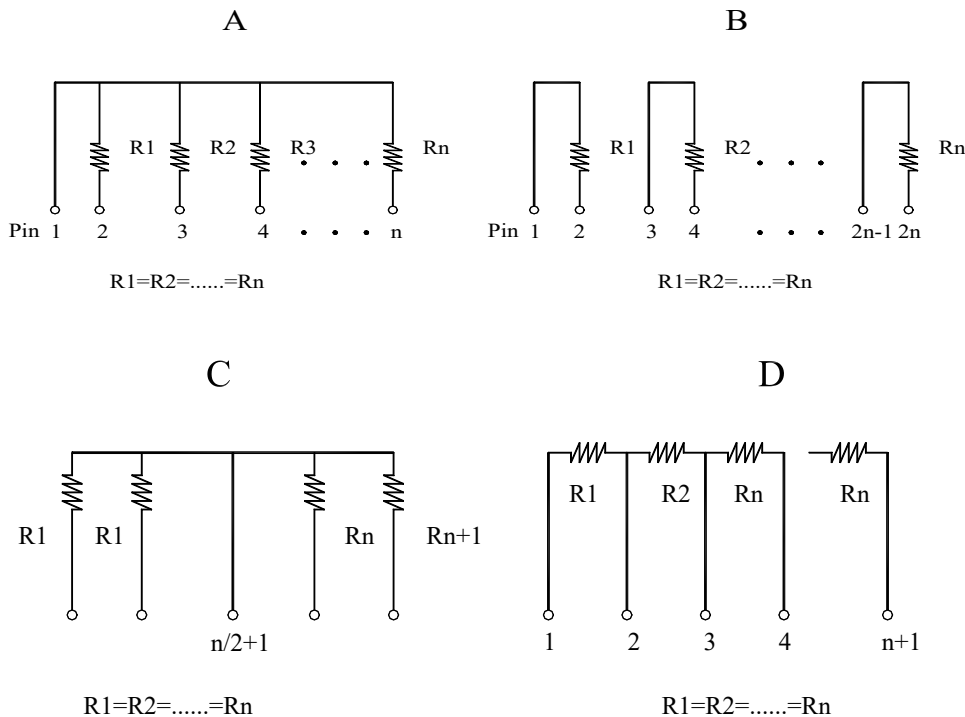

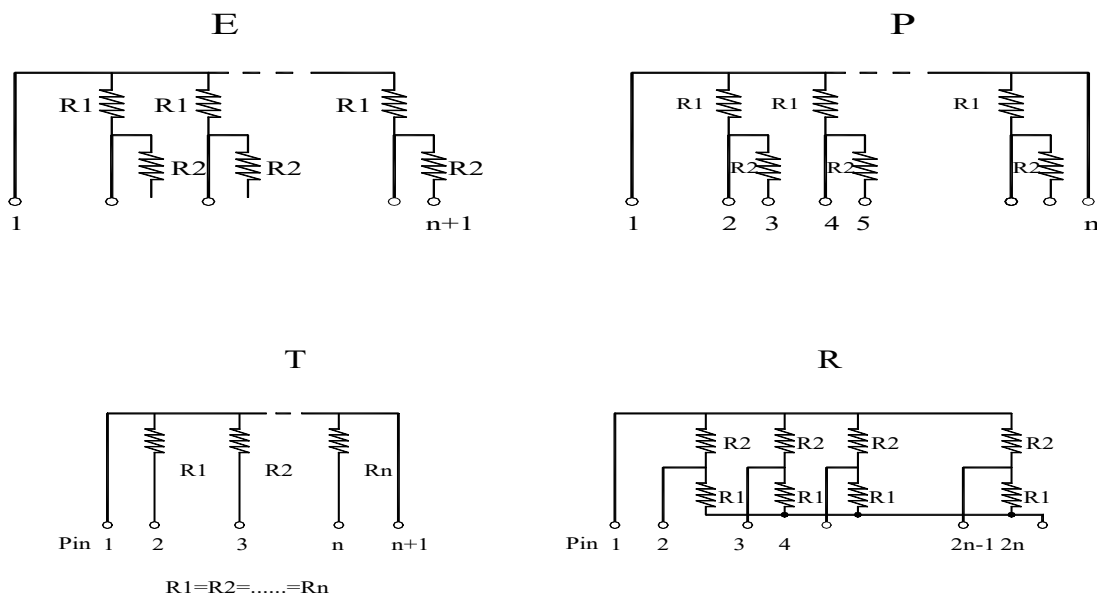

4. How to order

<u>RA</u>	<u>A</u>	<u>09</u>	<u>103</u>	<u>J</u>	<u>F</u>
Series	Circuit style	04= 4 Pin	RES. Value	RES.	F=Pb Free 本体印 F
RA= Low power	A style	05= 5 Pin	220= 22 Ω	F = ± 1%	FN=Pb Free 本体未印 F
RB= High power	B	06= 6 Pin	101= 100 Ω	G = ± 2%	其它特殊见料号说明
	C	07= 7 Pin	103= 10K Ω	J = ± 5%	
	D	:	105= 1M Ω		
	E	:	1822= 18.2K Ω		
	P	:	1005= 1M Ω		
	R	:			
	T	14=14 Pin			

5. Characteristics

Power rating

Series	Circuit style	Power rating
RA	B	0.2W
	A	0.125W
RB	All Style	0.25W

Mechanical characteristics

Item	Requirement	Test methods
Resistance to soldering heat	$\Delta R \leq \pm(1\% R_0 + 0.1 \Omega)$	With $260 \pm 5^\circ\text{C}$, for 3 sec.
Solder ability	Over 95% of termination must be covered with new solder	After immersing flux, dip in the $235 \pm 5^\circ\text{C}$ molten solder bath for 2 ± 0.5 sec.
Terminal strength (Tensile strength)	$\Delta R \leq \pm(1\% R_0 + 0.1 \Omega)$ No mechanical damage	Tensile: 1kg for 30 sec. Bending: 500g for 2 times
Exterior	No mechanical defect	Visual
Size	Within specification	Vernier calipers

SUBJECT: RESISTORS NETWORK SPECIFICATION SHEET

PAGE 3 OF 4

Electrical characteristics

Item	Requirement	Test methods
DC resistance	Within the specified tolerance	Refer to JIS C 5202 item 5.1
Temperature co-efficient (PPM/°C)	$R < 50 \Omega \pm 250 \text{ PPM}/^\circ\text{C}$ $50 \Omega \leq R < 2.2\text{M} \Omega \pm 100 \text{ PPM}/^\circ\text{C}$ $R \geq 2.2\text{M} \Omega \pm 250 \text{ PPM}/^\circ\text{C}$	$\text{TCR (PPM}/^\circ\text{C)} = (R_2 - R_1) / [R_1 \times (T_2 - T_1)]$ $T_1: 25^\circ\text{C}$ $T_2: \text{Test temperature } 25/-40/125^\circ\text{C}$ $R_1: \text{Resistance at TEMP. } T_1$ $R_2: \text{Resistance at TEMP. } T_2$
Short-time overload	$\Delta R \leq \pm (1\% R_0 + 0.1 \Omega)$	$2.5 \times \text{Rated voltage for 5 sec.}$ (200Vmax.) measure resistance after 30 minutes

Environment test

Item	Requirement	Test methods
Temperature cycle	$\Delta R \leq \pm (1\% R_0 + 0.1 \Omega)$	Repeat 5 cycles as follows -40°C 室温 125°C 室温 30min 15min 30min 15min
Load life in humidity	$\Delta R < \pm (3\% R_0 + 0.1 \Omega)$	Maintain the temperature of the resistor at $40 \pm 2^\circ\text{C}$ and 90-95% RH with the rated voltage applied for 1000+40/-0 hours. After two hours, measure value.
Load life	$\Delta R < \pm (3\% R_0 + 0.1 \Omega)$	Permanent resistance change after 1000 +40/-0 hours at RCWV of max., keep the resistor at $70 \pm 3^\circ\text{C}$ ambient.

6. Standard Resistance (OHM) E-12 Series

10	12	15	18	22	27	33	39	47	56	68	82
100	120	150	180	220	270	330	390	470	560	680	820
1K	1.2K	1.5K	1.8K	2.2K	2.7K	3.3K	3.9K	4.7K	5.6K	6.8K	8.2K
10K	12K	15K	18K	22K	27K	33K	39K	47K	56K	68K	82K
100K	120K	150K	180K	220K	270K	330K	390K	470K	560K	680K	820K
1M	1.2M	1.5M	1.8M	2.2M							

7. Dual Terminators (R2/R1) (OHM)

240/120 390/330 390/180 470/330
 270/220 3.3K/1.5K 330/220 6.2K/3.0K 4.7K/3.3K

DERATING CURVE

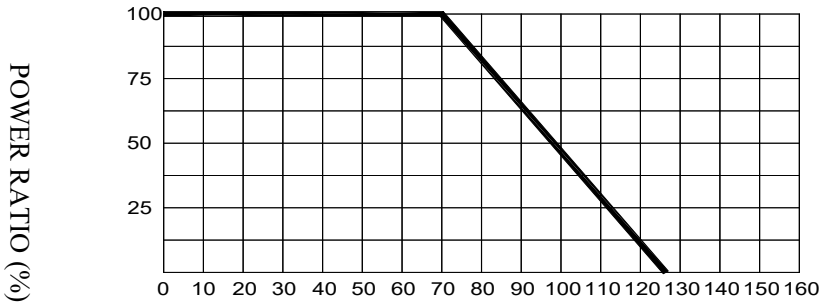

AMBIENT TEMPERATURE(°C)

8. Outgoing inspection sampling plan

1. MIL-STD-105D. Level II, Normal inspection
2. Single sampling
3. AQL:

Defective	CR	MA	MI
AQL	0	0.15	1.0

9. Packaging

Standard packing quantity: 200pcs per bag.