

(RoHS)

产 品 规 格 书

SPECIFICATION FOR APPROVAL

客户名称

Customer Name:

产品名称

Product Name:

贴片石英晶体谐振器

产品型号:

Product Type:

SMD 3225 (4PIN)

标称频率

Nominal Freq:

13.588900MHz

产品编号

Part Coding

7325-1358A1620-00

规格书编号:

Specification P/N:

XTY0292-7040

客户料号:

Customer P/N:

C389834

日期:

Date:

2019-06-15

客户承认

Approved By Customer:

签章

Signature:

日期

Date:



深圳市新天源电子有限公司

SHENZHEN XINTIANYUAN ELECTRONICS CO., LTD.

地 址: 深圳市宝安区石岩镇塘头宏发工业园1栋5楼

Add: 5/f.,Block 1,Hongfa Industrial Estate,Tangtou village,Shiyan Town,Baoan district,Shenzhen,Guangdong,China.

电话Tel: 0755-27650903 传真Fax: 0755-29833253

联系人: 王后勤 (小姐) 手机: 13728612903

E-mail: xyt@chinaxy.cn 网 址: [//www.chinaxy.cn](http://www.chinaxy.cn)

批准
Accepted

审核
Checked

编制
Issued 陈梅东

<p>深圳市新天源电子有限公司</p> <p>Shenzhen Xintianyuan Electronics Co., Ltd.</p>	<p>石英晶体谐振器规格书</p> <p>Specification of Quartz Crystal</p>	<p>NO: XTY0292-7040</p>
	<p>无源 SMD3225 4pin</p>	<p>Date: 2019/06/15</p>
<p>一、石英晶体规格参数</p> <p>Quartz Crystal Specification Parameters</p>		
<p>1、产品型号</p> <p>Holder Type</p>	<p>SMD 3225 (4pin)</p>	
<p>2、标称频率</p> <p>Nominal Frequency</p>	<p>13.588900MHz</p>	
<p>3、振动模式：</p> <p>Mode of Oscillation</p>	<p>Fundamental</p>	
<p>4、调整频差</p> <p>Frequency Tolerance at 25°C ±2°C</p>	<p>±20ppm at 25°C ±2°C</p>	
<p>5、等效电阻</p> <p>Equivalent Resistance(ESR)</p>	<p>≤60 Ω</p>	
<p>6、负载电容</p> <p>Load Capacitance(CL)</p>	<p>16pF</p>	
<p>7、温度频差</p> <p>Temperature Characteristics</p>	<p>±20ppm</p>	
<p>8、工作温度范围</p> <p>Operating Temperature range</p>	<p>-40~+85°C</p>	
<p>9、储存温度范围</p> <p>Storage Temperature range</p>	<p>-55~+125°C</p>	
<p>10、激励功率</p> <p>Drive Level</p>	<p>100uW</p>	
<p>11、静态电容</p> <p>Shunt Capacitance (C0)</p>	<p><4.0pF</p>	
<p>12、绝缘电阻</p> <p>Insulation Resistance</p>	<p>≥500MΩ (DC100V ±15V)</p>	
<p>13、测试仪器</p> <p>Measure Instrument</p>	<p>250B</p>	
<p>14、年老化率</p> <p>Aging Rate a Year</p>	<p>≤±3ppm/年</p>	

深圳市新天源电子有限公司 Shenzhen Xintianyuan Electronics Co., Ltd.	石英晶体谐振器规格书 Specification of Quartz Crystal	NO: XTY0292-7040
	无源 SMD3225 4pin	Date: 2019/06/15

二、石英晶体尺寸、结构

Quartz Crystal Dimensions And Structure

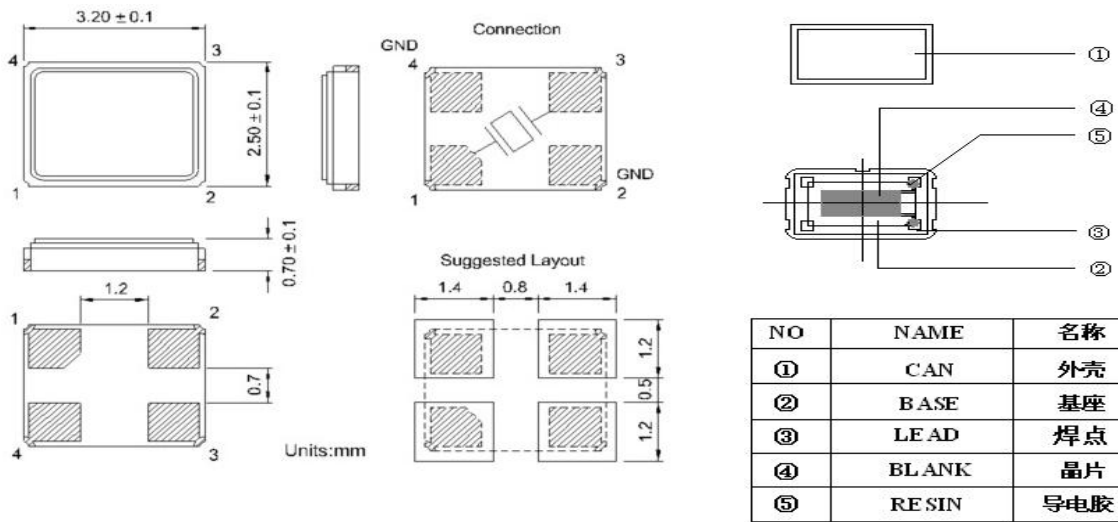

三、石英晶体印字

Quartz Crystal Marking

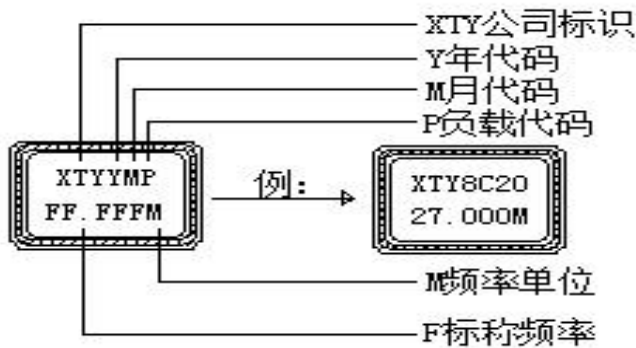

印字: Marking

XTY: 新天源

Y为年(year): 8:2018; 9:2019...

M为月(Month): A:1; B:2...

P为负载 CL:20: 20pF

FF. FFFM为频率Frequency: 27.000M

例8C20: 8为2018年, C为3月, 20为20pF;

年、月、负载代码:

年	2015	2016	2017	2018	2019	2020	2021	2022	2023	2024	2025	2026
代码	5	6	7	8	9	0	1	2	3	4	5	6
月	1	2	3	4	5	6	7	8	9	10	11	12
代码	A	B	C	D	E	F	G	H	I	J	K	L
负载	9pF	10pF	11pF	12pF	13pF	14pF	15pF	16pF	17pF	18pF	19pF	SERIES
代码	9	10	11	12	13	14	15	16	17	18	19	S

深圳市新天源电子有限公司 Shenzhen Xintianyuan Electronics Co., Ltd.	石英晶体谐振器规格书 Specification of Quartz Crystal	NO: XTY0292-7040
	无源 SMD3225 4pin	Date: 2019/06/15

四、包装要求
Packaging

1. 编带
Tape



Type	W	E	F	T	P	P0	P2	D0	D1	A0	KO	B0
SMD 3225	8.00	1.75	3.50	0.25	4.00	4.00	2.00	∅1.5	∅1.0	2.75	0.95	3.50

Unit: mm

2. 轮
Reel

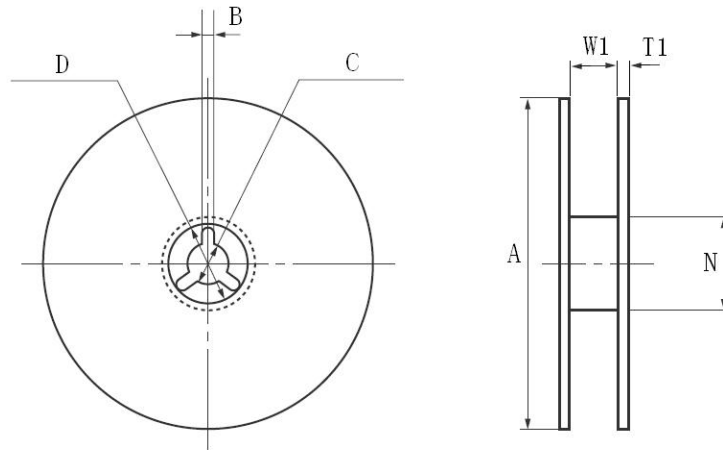

Type	A	B	C	D	N	W1	T1
SMD 3225	∅178	2.5	∅13	∅22.2	∅60	8.5	1.0

Unit: mm

深圳市新天源电子有限公司 Shenzhen Xintianyuan Electronics Co., Ltd.	石英晶体谐振器规格书 Specification of Quartz Crystal	NO: XTY0292-7040
	无源 SMD3225 4pin	Date: 2019/06/15

3. 包装
Package

3000只/1卷
3000pcs/Reel

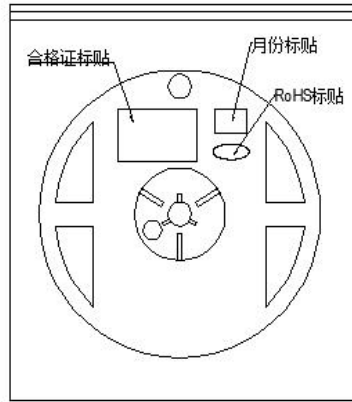

1轮=1盒
1Reel=1Box
Units: mm

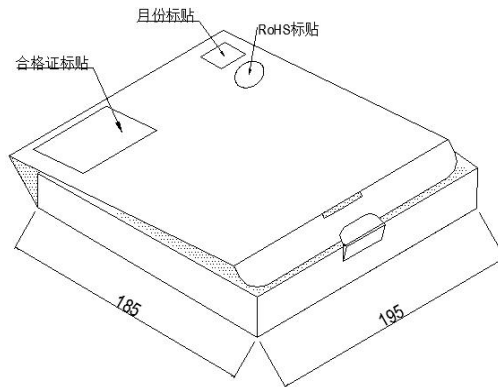

合格证	
频率:	型号:
负载:	电阻:
频差:	数量:
日期:	供应商:
批号:	编号:
订单号:	料号:

包装箱
Shipping Carton

40*34*21.5 (20 Box)
27*20*32.2 (12 Box)
27*20*20 (8 Box)
Units: cm

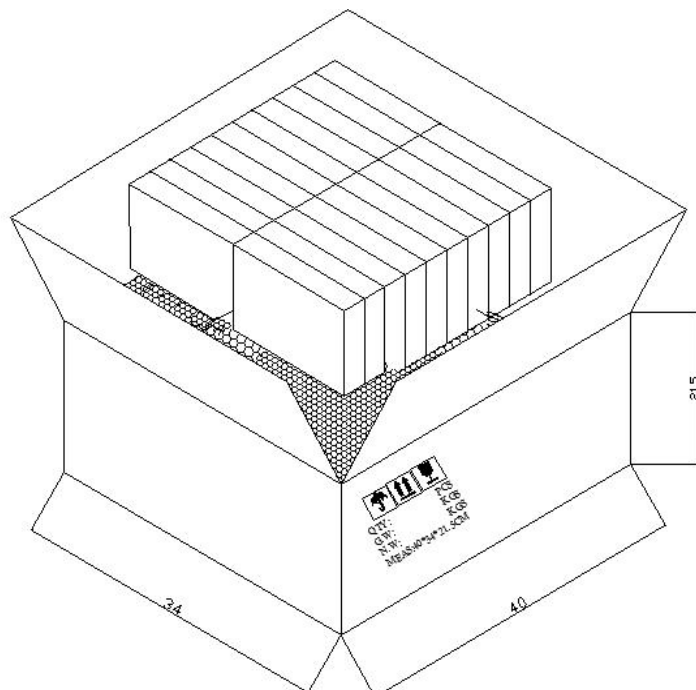

深圳市新天源电子有限公司 Shenzhen Xintianyuan Electronics Co., Ltd.	石英晶体谐振器规格书 Specification of Quartz Crystal	NO: XTY0292-7040
	无源 SMD3225 4pin	Date: 2019/06/15

五、石英晶体可靠性
Reliability Test

NO.	测试项目 Test Item	可靠性条件 Testing Condition	判定标准 Determinant Criteria
1.	跌落 Dropping Test	从75cm高度跌落到30mm厚硬木板上, 跌落三次 Drop the resonators from 75cm height to 30mm thick hardwood board, 3times.	$\Delta FL \leq \pm 5\text{ppm}$ $\Delta RS \leq \pm 10\%$ or $5\ \Omega$ (whichever is larger)
2.	振动 Vibration	频率 Frequency:10~60Hz; 幅度 Amplitude:0.75mm; 周期 Cycle time:10-55-10Hz: 1min; 振动方向 Direction:X, Y, Z; 振动时间 Duration: 每个方向2小时 2 h/direction.	$\Delta FL \leq \pm 5\text{ppm}$ $\Delta RS \leq \pm 10\%$ or $5\ \Omega$ (whichever is larger)
3.	高温 Heat Resistance	温度Temperature: $125^{\circ}\text{C} \pm 10^{\circ}\text{C}$ 时间Time: 720 ± 24 Hours	$\Delta FL \leq \pm 5\text{ppm}$ $\Delta RS \leq \pm 10\%$ or $5\ \Omega$ (whichever is larger)
4.	低温 Cold Resistance	温度Temperature: $-40^{\circ}\text{C} \pm 10^{\circ}\text{C}$ 时间Time: 720 ± 24 Hours	$\Delta FL \leq \pm 5\text{ppm}$ $\Delta RS \leq \pm 10\%$ or $5\ \Omega$ (whichever is larger)
5.	回流焊 (2次) Reflow (2times)	 <p>回流焊Reflow $260^{\circ}\text{C} \pm 5^{\circ}\text{C} \leq 10\text{s}$</p>	$\Delta FL \leq \pm 5\text{ppm}$ $\Delta RS \leq \pm 10\%$ or $5\ \Omega$ (whichever is larger)
6.	耐焊接热 Resistance To Soldering Heat	焊接温度Soldering Heat: $320^{\circ}\text{C} \pm 10^{\circ}\text{C}$ 测试时间Test Time: $3.5\text{s} \pm 0.5\text{s}$;	$\Delta FL \leq \pm 5\text{ppm}$ $\Delta RS \leq \pm 10\%$ or $5\ \Omega$ (whichever is larger)
7.	气密性 Leakage	用氦质谱仪进行检测, 试验气体: He; 真空度: $1 \times 10^{-3}\text{Pa}$; Helium mass-mass-spectrometer detector, and vacuum and reach $1 \times 10^{-3}\text{Pa}$;	$\leq 1 \times 10^{-8}\text{atm} \cdot \text{cc/S}$
8.	高温高湿 Constant Temperature and Humidity	在温度 $60^{\circ}\text{C} \pm 5^{\circ}\text{C}$, 湿度90%~99%, 储存720小时, 取出2小时后测试; Stored at $60^{\circ}\text{C} \pm 5^{\circ}\text{C}$, Humidity 90%~99% For a period of minimum 720hours. Then $25^{\circ}\text{C} \pm 3^{\circ}\text{C}$ and 2 hours before testing	$\Delta FL \leq \pm 5\text{ppm}$ $\Delta RS \leq \pm 10\%$ or $5\ \Omega$ (whichever is larger) Appearance OK
9.	温度冲击 Temperature Shock	低温Low $-40^{\circ}\text{C} \pm 2^{\circ}\text{C}$ (120min) \leftrightarrow 高温High $85^{\circ}\text{C} \pm 2^{\circ}\text{C}$ (120min); 循环10次; For 10 cycles	$\Delta FL \leq \pm 5\text{ppm}$ $\Delta RS \leq \pm 10\%$ or $5\ \Omega$ (whichever is larger)