

1. 適用範圍 / SCOPE

此份規格書僅涵蓋1206T系列產品.

This specification covers 1206T series devices, which is SMD Fuse.

2. 產品名稱及編碼 / TYPE NUMBER & PART NUMBER

2-1 產品名稱/ TYPE NUMBER

1206T	****A	***V	
(1)	(2)	(3)	(4)

- (1) 系列號: 1206T (尺寸: 0.12×0.06; 熔斷特性:慢斷)
Series Number: 1206T (Size: 0.12×0.06; Melting characteristic: Slow-Blow)
- (2) 額定電流: (例如:3.50A=3.50 安培)
Rating Current : (Ex. :3.50A = 3.50 Ampere)
- (3) 額定電壓: (例如:063V=63 伏特)
Rating Voltage : (Ex. :063V = 63 Volt)
- (4) 安規認證 / Safety Approval

2-2 產品編碼 / PART NUMBER

1206	-	T	-	*A**	-	***
(1)		(2)		(3)		(4)

- (1) 尺寸: 0.12×0.06
Size: 0.12×0.06
- (2) 熔斷特性: 慢斷
Melting characteristic: Slow-Blow
- (3) 額定電流: (例如:3A50=3.50 安培)
Rating Current : (Ex. :3A50 = 3.50 Ampere)
- (4) 額定電壓: (例如:063=63 伏特)
Rating Voltage : (Ex. :063 = 63 Volt)

3. 產品尺寸和結構 / SIZE AND STRUCTURE

3-1 尺寸 (單位: mm) / SIZE (Unit: mm)

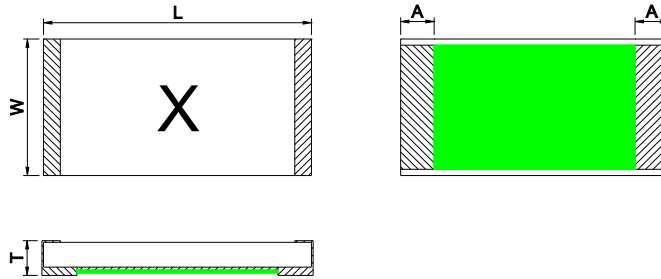

型號 / Type number	W	L	T	A
1206T****A***V	1.60±0.20	3.20±0.20	0.60±0.15	0.58±0.20

3-2 產品結構及使用材料說明 / STRUCTURE & MATERIAL

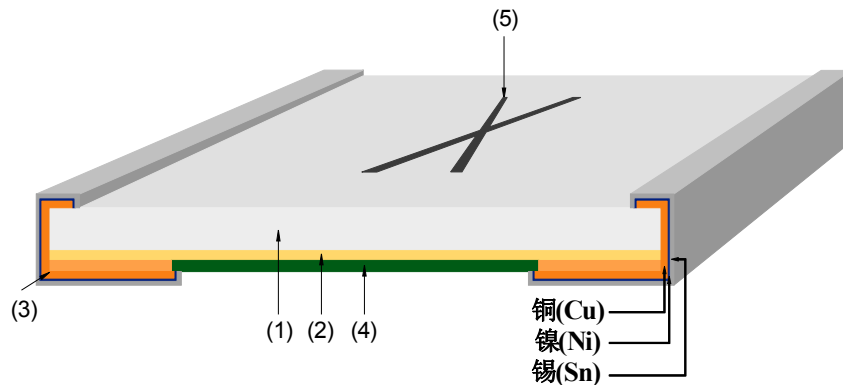

編號 No.	元件 Component	材質 Material	數量 Quantity
(1)	基板 Substrate	氧化鋁陶瓷 Alumina Ceramic	1
(2)	熔絲本體 Fuse element	銅合金/錫 Cu Alloy / Sn	1
(3)	端電極 Terminal electrode	銅/鎳/錫 Cu / Ni / Sn	2
(4)	保護防焊層 Protective coating	防火級環氧樹脂 Flame-retardant epoxy	1
(5)	文印防焊層 Marking coating	防火級環氧樹脂 Flame-retardant epoxy	1

4. 基本資訊/ ORDERING INFORMATION

● approved ○ pending

型號 Type Number	標示 Marking	額定電流 Rated Current	額定電壓 Rated Voltage	阻值 Nominal Resistance	I ² t Nominal Melting I ² t	安規認證 Safety Approval
		(ADC)	(VDC)	(Ω)	(A ² s)	
1206T 1.00A 063V	P	1.0	63	0.2200	0.259	●
1206T 1.25A 063V	Q	1.25	63	0.1550	0.405	●
1206T 1.50A 063V	Q1	1.5	63	0.1100	0.583	●
1206T 2.00A 063V	S	2.0	63	0.0620	1.036	●
1206T 2.50A 063V	T	2.5	63	0.0305	1.619	●
1206T 3.00A 063V	T1	3.0	63	0.0250	2.332	●
1206T 3.50A 063V	U1	3.5	63	0.0180	3.174	●
1206T 4.00A 063V	V	4.0	63	0.0155	4.145	●
1206T 5.00A 063V	W	5.0	63	0.0110	6.477	●
1206T 6.00A 063V	W1	6.0	63	0.0128	9.327	●
1206T 6.30A 063V	X	6.3	63	0.0095	10.283	●
1206T 7.00A 063V	X1	7.0	63	0.0085	12.696	●
1206T 8.00A 063V	Y	8.0	63	0.0075	16.582	●
1206T 10.0A 063V	Z	10.0	63	0.0057	25.909	●

說明/Notes :

a. “一般電阻值”是在通以小於額定電流的 10%的弱電流條件下量測的阻抗.

Nominal Resistance measured with < 10% rated current ;

 b. “一般 I²t ” 的是指自通電至作動時間為 10ms 的過程所對應的 I²t.

 Nominal Melting I²t measured at 10 m sec opening time ;

5. 電氣特性 / ELECTRICAL CHARACTERISTICS
5-1 時間-電流特性 / Pre-Arcing Time-Current Characteristics (limits)

額定電流 RATED CURRENT	1.0In	2.0In	3.0In	8.0In	10.0In
1.0A to 10A	4hrs min.	1sec min ; 120sec max.	0.1sec min ; 3sec max.	2ms min ; 50ms max.	0.2ms min ; 20ms max.

In : 25°C 下額定電流 / Rating Current at 25°C

時間-電流特性曲線 / Time-Current Curve:

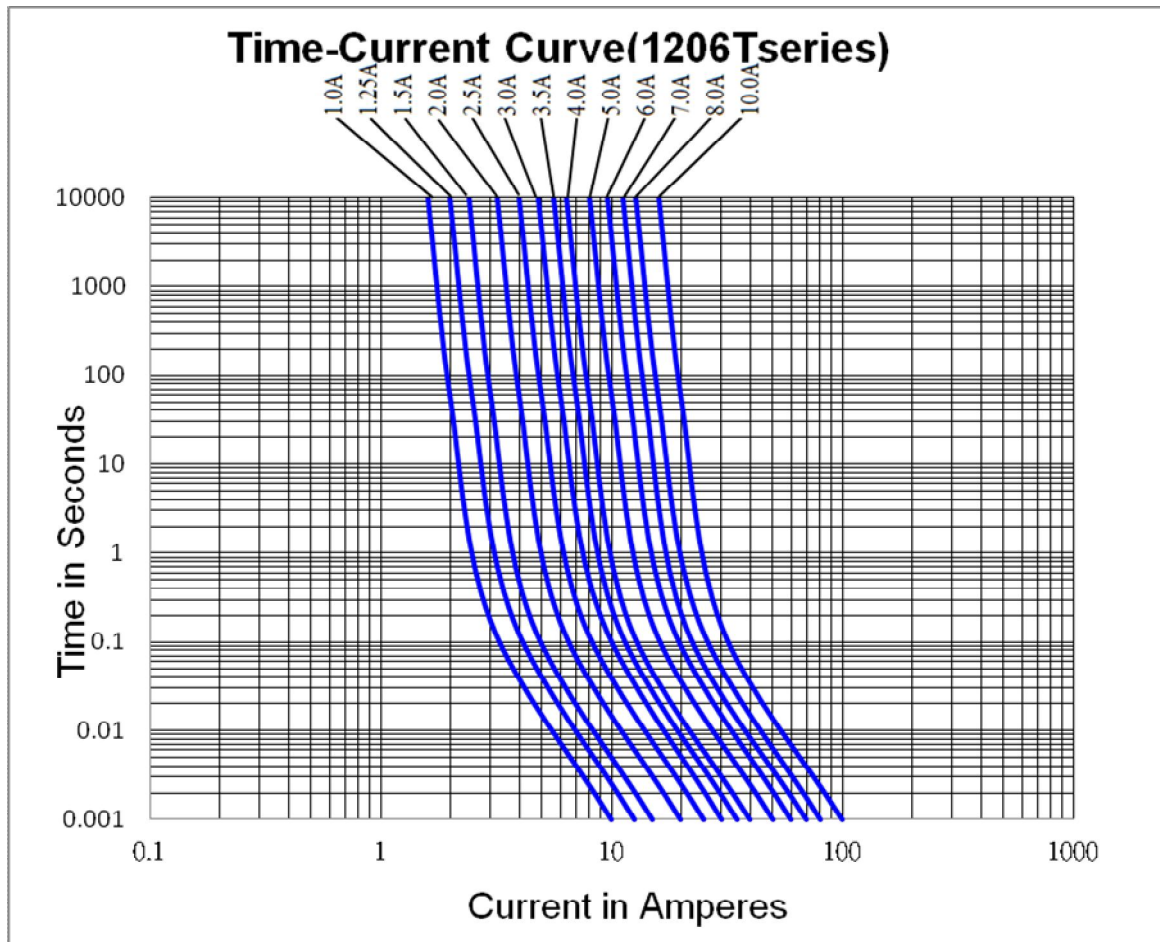

5-2 I²t-t 曲線 / I²t-t Curve:

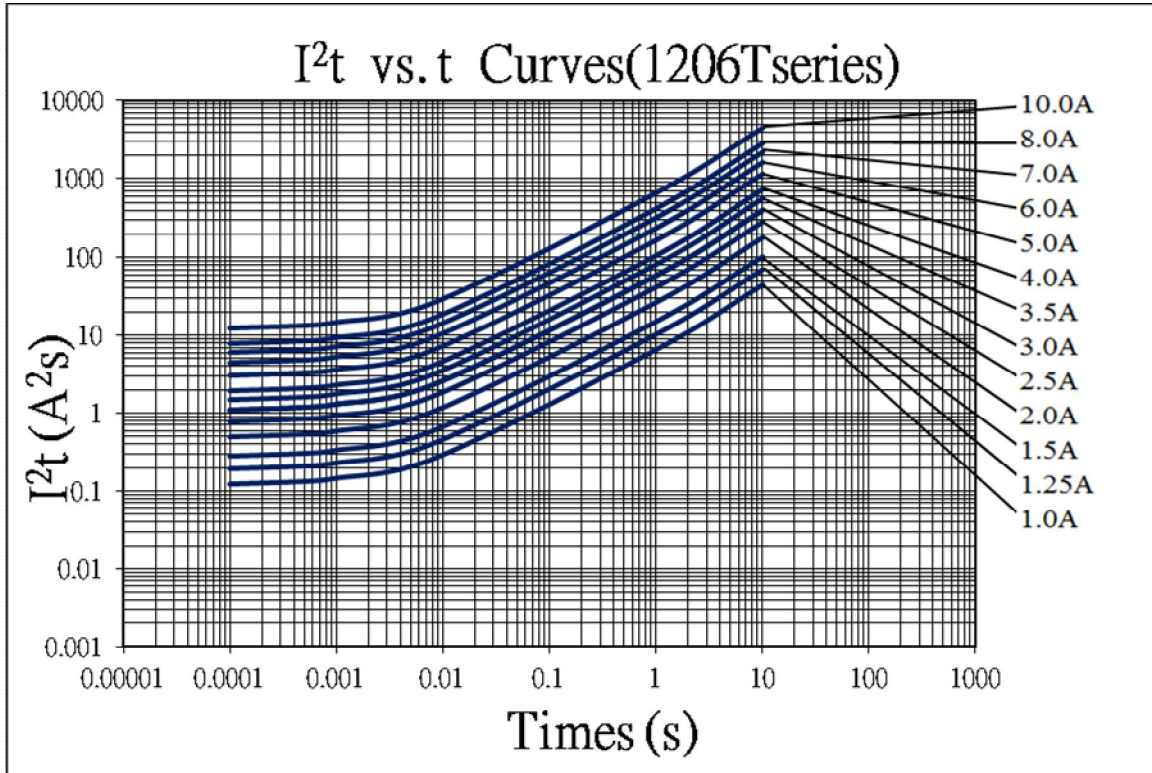

5-3 分斷能力 / Breaking Capacity

額定電流 RATED CURRENT	分斷能力 BREAKING CAPACITY
1.0A ~10.0A	V =63V DC ; I=50A

6. 產品特性及信賴性測試規範/PRODUCT CHARACTERISTICS AND RELIABILITY TEST STANDARD

序號 No.	項目 Item	內容 Content	判定標準 Criteria
1	時間/電流特性 Time/current characteristics	分別通以1.0In、2.0In、3.0In、8.0In、10.0In電流，得出相對應的時間 I=1.0In ; 2.0In ; 3.0 In ; 8.0 In ; 10.0 In and measure the value of time individually by meter ,	各電流條件下的時間參數符合規定值 Value of time measured in different currents is within spec. UL248-1/-14
2	分斷能力測試 Breaking capacity	V = 63V/DC ; I=50A	沒有持續電弧、燃燒、爆炸現象 No a permanent arcing, ignition, bursting UL248-1/-14
3	可焊性 Solder ability	熔錫溫度245°C±5°C，浸錫時間5s±0.5s，浸入深度從基座面起2.0mm±0.5mm，放在20X的放大鏡下檢查T=245°C±5°C，t=5s±0.5s，magnifier : 20X	錫覆蓋率≥95% Cover ≥ 95% MIL-STD-202 Method 208
4	抗焊性測試 Soldering heat resistance	熔錫溫度/ T =250°C±5°C，浸錫時間 / t =30±5s T=250±5°C，t=30±5s	外觀無裂紋和損傷，前後阻值偏差小於或等於±15%；文印清晰可辨 No crack and damage, ΔR<15% Marking is easily legible MIL-STD-202, Method 210F, Condition K
5	冷熱衝擊 Thermal Shock	-65°C,放置時間為15min,→25°C，,放置時間為5min→125°C放置時間15min 循環次數為100個 -65°C 15min~25°C 5min~ +125°C 15min ; 100 cycles	外觀無裂紋和損傷，前後阻值偏差<±10% No crack and damage, ΔR<10% MIL-STD-202, Method 107G conditionB-3
6	機械衝擊 Mechanical Shock	峰值100 G,持續時間11ms,波形：半正弦，五次脈衝 a=100G for 11ms, 5pulses	外觀無裂紋和損傷，前後阻值偏差<±10%。 No crack and damage, ΔR<10% MIL-STD-202, Method 213B
7	振動測試 Vibration	承受振幅為0.03 英寸(全程最大0.06英寸),頻率在大約10Hz到55Hz 的範圍均勻地變化的簡諧運動.)	MIL-STD-202, Method 201A
8	高頻振動測試 Vibration, High Frequency	20g's峰值，公差值為±10%，振動頻率10Hz-2000Hz，總計時間為12h	MIL-STD-202, Method 204D, Condition D

7. 環境特性 / ENVIRONMENTAL CHARACTERISTIC

7-1 操作溫度範圍: -55°C ~ 150°C / Operating Temperature:-55°C ~ 150°C

若貴司操作環境溫度超出25±5°C範圍，在選用保險絲規格時，需考慮操作環境溫度對保險絲的影響。請參照：溫度-電流曲線圖。

When choosing the fuse's specification, if the operating environmental temperature beyond the scope from 20~30°C, you should consider the environmental temperature's affection to fuses. please refer:

Temperature-Current curve:

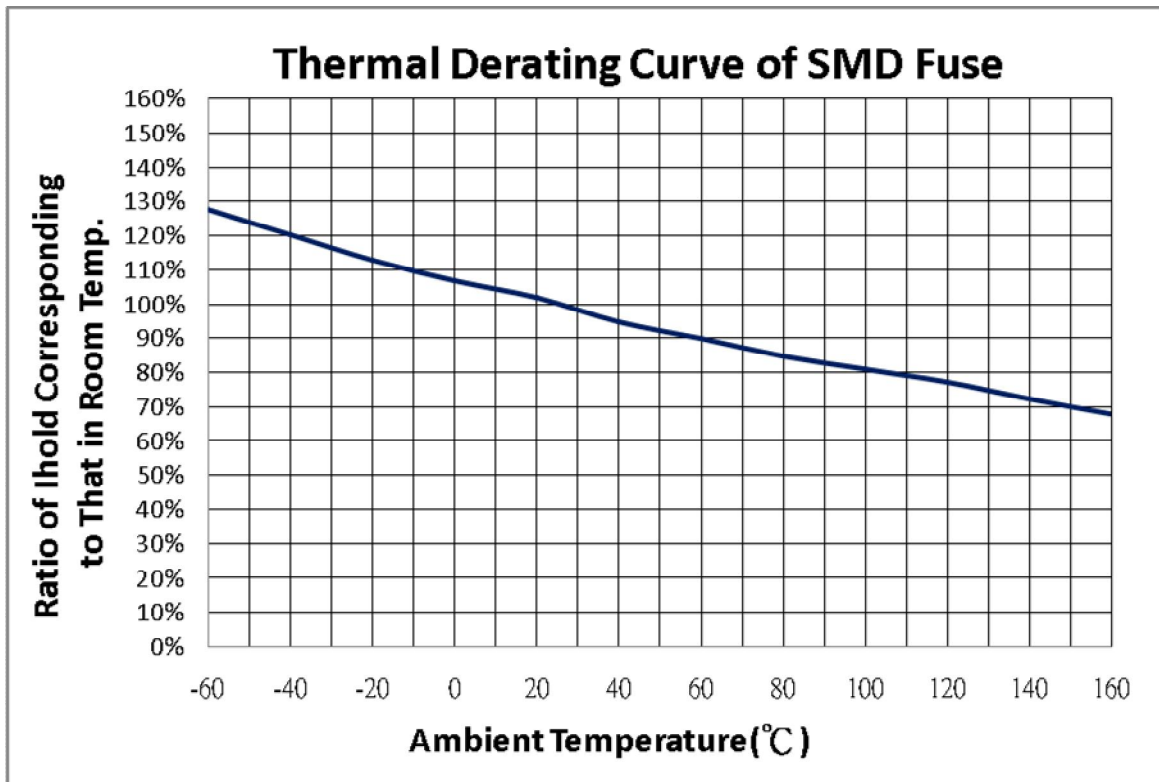

7-2 存儲條件 / Storage Conditions

在溫度10°C~40°C、相對濕度≤75%的密閉條件下可存放2年。

Under airtight in temperature10°C~40°C、relative humidity ≤75% can store 2 years.

在溫度10°C~40°C、相對濕度為95%的非露天下最多可存放30天。

Without dew in temperature10°C~40°C、relative humidity be 95% maximum value for 30days.

8. 焊墊尺寸及焊接條件 / SOLDER PAD SIZE AND WELDING CONDITIONS

8-1 焊墊尺寸建議 / Recommended Size of the Pad.

L	W	D	t
4.05mm	2.40mm	1.25mm	≥ 35μm

t : 元件焊墊金屬層厚度 (min.) / t : Thickness of pad metal (min.)

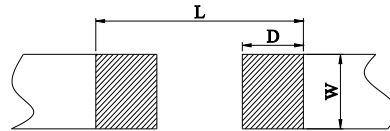

8-2 焊接參數建議 / Recommended Customer Soldering Parameters

溫度曲線 Temperature Condition

預熱段 : 145 ± 15°C, max. 120 sec.

Preheating : 145 ± 15°C, max. 120 sec.

焊錫段 : min. 220°C, max. 60 sec.

Soldering: min. 220°C, max. 60 sec.

允許最高溫度 : 260±5°C, max. 10sec.

Maximum temperature : 260±5°C, max. 10sec.

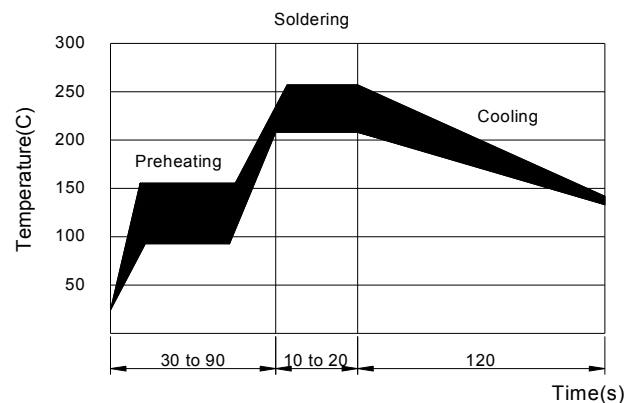

允許烙鐵焊接條件(熱風設備) : 350°C, 3~5seconds

Rework Temperature (hot air equipment) : 350°C, 3~5seconds

8-3 焊接方法建議 / Recommended Reflow Methods

焊接熱源方式可用紅外線, 熱蒸氣, 熱風

IR, vapor phase oven, hot air oven.

如果焊錫溫度超過允許最高溫度, 則產品本身會有功能損壞的疑慮

If reflow temperatures exceed the recommended profile, devices may not meet the performance requirements.

9. 批量生產出貨測試項目 / LOT ACCEPTANCE TEST REQUIREMENTS

9-1 外觀 / Visual

方法：利用放大鏡進行檢查

Procedure: Visual

標準：不能有髒汙、不潔、文印錯誤、破損等

Acceptance Criteria: No parts are outstandingly stained.

9-2 尺寸 / Dimensions

方法：使用合適且經校正的尺規

Procedure: As appropriate, calipers, micrometers, optical comparator, or approved gages.

標準：尺寸均在規定標準範圍內

Acceptance Criteria: No parts outside specific dimensions.

9-3 時間-電流特性 / Time-Current Characteristics

方法：測試電流 $I=1.0I_n$; $2.0I_n$; $3.0I_n$; $8.0I_n$; $10.0I_n$,量測出個別電流下的對應時間

Procedure : $I=1.0I_n$; $2.0I_n$; $3.0I_n$; $8.0I_n$; $10.0I_n$ and measure the value of time individually by meter at 25°C

標準：對應時間值均在規定標準範圍內

Acceptance Criteria: All parts must within the specific .

9-4 分斷能力 / Breaking Capacity

方法：測試電壓\電流為 $V = 63\text{V}/\text{DC}$; $I=50\text{A}$, 利用此條件衝擊元件

Procedure: $V = 63\text{VDC}$; $I=50\text{A}$

標準：元件不發生持續電弧燃燒及爆裂

Acceptance Criteria: No permanent arcing, ignition, bursting

10. 安全認證及編號 / STANDARDS AND APPROVALS

	E56092
---	--------

11. 包裝訊息 / PACKING INFORMATION
11-1 包裝數量、重量 / QUANTITY & WEIGHT

編碼 Part Number	數量 (pcs) Quantity(pcs)	重量(g) Weight(g)
1206 - T - * A** - ***	5,000	140±20

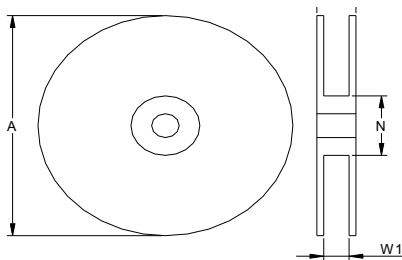
11-2 捲輪規格 / Reel & Tape specifications

Unit(mm)

A ± 5	N ± 2	W1 +1/-0
178	60	8.4

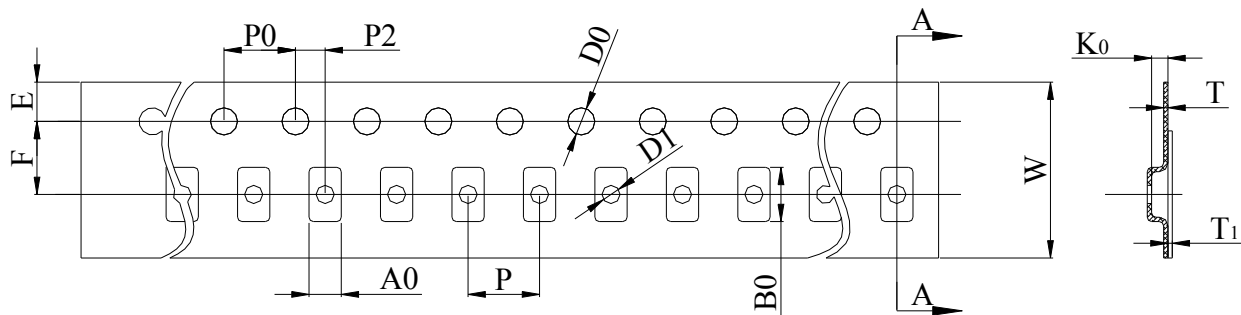

單位(mm)

W	8.00±0.10	E	1.75 ± 0.10
P0	4.00 ± 0.10	T	0.20±0.05
P	4.00 ± 0.10	T1	Max. 0.1
P2	2.00 ± 0.10	A0	2.05±0.10
D0	1.50 ± 0.10	B0	3.65±0.10
D1	1.00 ± 0.10	K0	0.85±0.10
F	3.50±0.10		

11-3 密封膠膜剝離強度要求 / Peeling Strength of Seal Tape

F = 剝離強度 : 0.3 – 1.0N (30 - 100gf)

F = Peeling Strength: 0.3 – 1.0N (30 - 100gf)

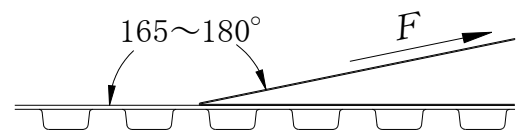

12. 其他 / OTHERS

12-1 如果在使用中有超出本規格書的要求，必須經由雙方協商確認。

In the event that an impropriety is found beyond this specification ,it shall be fixed by mutual agreement between the parties.

12-2 如果本規格書有不適當的情況，必須通過雙方協商並由本公司修改。

In the event that an impropriety is found in this specification , Walter Electronic Technology Co., Ltd. shall amend it by mutual agreement between the parties.

版次	製作	確認	審核
第1.1版	劉九生	黃強	Russel



UL iQ for Fuses



Fuses

E56092

Guide Information

SUZHOU WALTER ELECTRONIC CO LTD

Fenhu Technic Development Zone, Wujiang Jiangsu 215211 CN

F92, 1206T

Supplemental micro fuses

<u>Size</u> <u>mm(in)</u>	<u>Amps</u> <u>(A)</u>	<u>Volts</u> <u>(V)</u>	<u>Interrupting</u> <u>Rating (A)</u>
3.2 x 1.6 (0.13 x 0.06)	0.8	63Vdc	50
	1	63Vdc	50
	1.25 - 1.75	63Vdc	50
	2 - 6	63Vdc	50
	6.3 - 10	63Vdc	50
	0.8	24Vdc	50
	0.8	32Vdc	50
	1	24Vdc	50
	1	32Vdc	50
	1.25 - 1.75	24Vdc	50
	1.25 - 1.75	32Vdc	50
	2 - 6	24Vdc	50
	2 - 6	32Vdc	50
	6.3 - 10	24Vdc	50
	6.3 - 10	32Vdc	50

Report Date: 2010-07-13

Last Revised: 2018-09-04

© 2018 UL LLC

