

## Features

- N-Channel, 5V Logic Level Control
- Enhancement mode
- Very low on-resistance  $R_{DS(on)}$  @  $V_{GS}=4.5V$
- Fast Switching
- 100% Avalanche test
- Pb-free lead plating; RoHS compliant

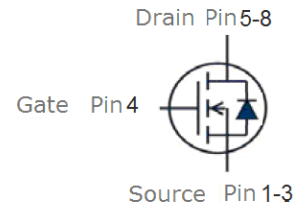

$V_{DS}$	60	V
$R_{DS(on),TYP}$ @ $V_{GS}=10V$	7.0	m $\Omega$
$R_{DS(on),TYP}$ @ $V_{GS}=4.5V$	8.0	m $\Omega$
$I_D$	18	A



Part ID	Package Type	Marking	Tape and reel information
VS6018AS	SOP8	6018AS	3000pcs/reel

Maximum ratings, at  $T_A=25^\circ\text{C}$ , unless otherwise specified

Symbol	Parameter	Rating	Unit	
<b>Common Ratings (<math>T_A=25^\circ\text{C}</math> Unless Otherwise Noted)</b>				
$V_{GS}$	Gate-Source Voltage	$\pm 20$	V	
$V_{(BR)DSS}$	Drain-Source Breakdown Voltage	60	V	
$T_J$	Maximum Junction Temperature	150	$^\circ\text{C}$	
$T_{STG}$	Storage Temperature Range	-55 to 150	$^\circ\text{C}$	
$I_S$	Diode Continuous Forward Current	$T_A=25^\circ\text{C}$ 2.6	A	
<b>Mounted on Large Heat Sink</b>				
$I_D$	Continuous Drain current @ $V_{GS}=10V$	$T_A=25^\circ\text{C}$	18	A
		$T_A=100^\circ\text{C}$	12	A
$I_{DM}$	Pulse Drain Current Tested ①	$T_A=25^\circ\text{C}$	72	A
$P_D$	Maximum Power Dissipation	$T_A=25^\circ\text{C}$	3.1	W
$R_{\theta JC}$	Thermal Resistance-Junction to Case		24	$^\circ\text{C/W}$
$R_{\theta JA}$	Thermal Resistance Junction-Ambient		40	$^\circ\text{C/W}$
<b>Drain-Source Avalanche Ratings</b>				
EAS	Avalanche Energy, Single Pulsed ②		196	mJ



Symbol	Parameter	Condition	Min.	Typ.	Max.	Unit
<b>Static Electrical Characteristics @ T<sub>A</sub> = 25°C (unless otherwise stated)</b>						
V <sub>(BR)DSS</sub>	Drain-Source Breakdown Voltage	V <sub>GS</sub> =0V I <sub>D</sub> =250μA	60	--	--	V
I <sub>DSS</sub>	Zero Gate Voltage Drain Current(T <sub>J</sub> =25°C)	V <sub>DS</sub> =60V,V <sub>GS</sub> =0V	--	--	1	μA
	Zero Gate Voltage Drain Current(T <sub>J</sub> =125°C)	V <sub>DS</sub> =60V,V <sub>GS</sub> =0V	--	--	100	μA
I <sub>GSS</sub>	Gate-Body Leakage Current	V <sub>GS</sub> =±20V,V <sub>DS</sub> =0V	--	--	±100	nA
V <sub>GS(TH)</sub>	Gate Threshold Voltage	V <sub>DS</sub> =V <sub>GS</sub> ,I <sub>D</sub> =250μA	1.0	2.0	3.0	V
R <sub>DS(ON)</sub>	Drain-Source On-State Resistance <sup>③</sup>	V <sub>GS</sub> =10V, I <sub>D</sub> =15A	--	7.0	9.0	mΩ
R <sub>DS(ON)</sub>	Drain-Source On-State Resistance <sup>③</sup>	V <sub>GS</sub> =4.5V, I <sub>D</sub> =10A	--	8.0	12.0	mΩ
<b>Dynamic Electrical Characteristics @ T<sub>A</sub> = 25°C (unless otherwise stated)</b>						
C <sub>iss</sub>	Input Capacitance	V <sub>DS</sub> =30V,V <sub>GS</sub> =0V, f=1MHz	--	3000	--	pF
C <sub>oss</sub>	Output Capacitance		--	295	--	pF
C <sub>rss</sub>	Reverse Transfer Capacitance		--	270	--	pF
R <sub>g</sub>	Gate Resistance	f=1MHz		1.6		Ω
Q <sub>g</sub>	Total Gate Charge	V <sub>DS</sub> =24V,I <sub>D</sub> =10A, V <sub>GS</sub> =10V	--	82	--	nC
Q <sub>gs</sub>	Gate-Source Charge		--	13	--	nC
Q <sub>gd</sub>	Gate-Drain Charge		--	17	--	nC
<b>Switching Characteristics</b>						
t <sub>d(on)</sub>	Turn-on Delay Time	V <sub>DD</sub> =30V, I <sub>D</sub> =1A, R <sub>G</sub> =6.8Ω, V <sub>GS</sub> =10V	--	26	--	nS
t <sub>r</sub>	Turn-on Rise Time		--	125	--	nS
t <sub>d(off)</sub>	Turn-Off Delay Time		--	58	--	nS
t <sub>f</sub>	Turn-Off Fall Time		--	112	--	nS
<b>Source- Drain Diode Characteristics @ T<sub>A</sub> = 25°C (unless otherwise stated)</b>						
V <sub>SD</sub>	Forward on voltage	I <sub>SD</sub> =10A,V <sub>GS</sub> =0V	--	--	1.2	V
t <sub>rr</sub>	Reverse Recovery Time	T <sub>J</sub> =25°C,I <sub>sd</sub> =10A, V <sub>GS</sub> =0V di/dt=200A/μs	--	38	--	nS
Q <sub>rr</sub>	Reverse Recovery Charge		--	44	--	nC

**NOTE:**

- ① Repetitive rating; pulse width limited by max. junction temperature.
- ② Limited by T<sub>Jmax</sub>, starting T<sub>J</sub> = 25°C, L = 0.5mH,R<sub>G</sub> = 25Ω, I<sub>AS</sub> = 28A, V<sub>GS</sub>=10V. Part not recommended for use above this value
- ③ Pulse width ≤ 300μs; duty cycle≤ 2%.

Typical Characteristics

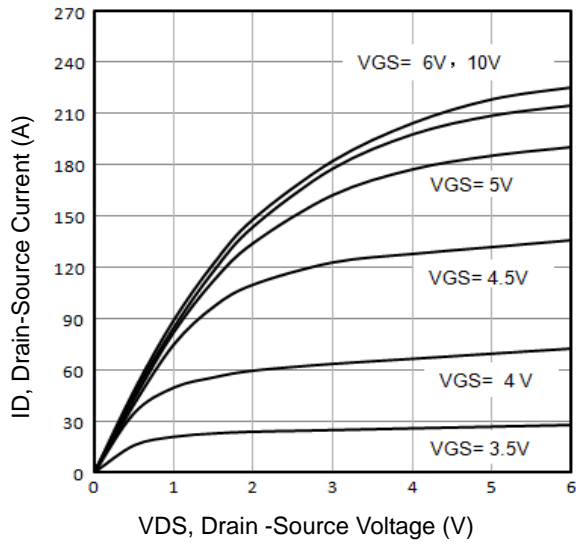

Fig1. Typical Output Characteristics

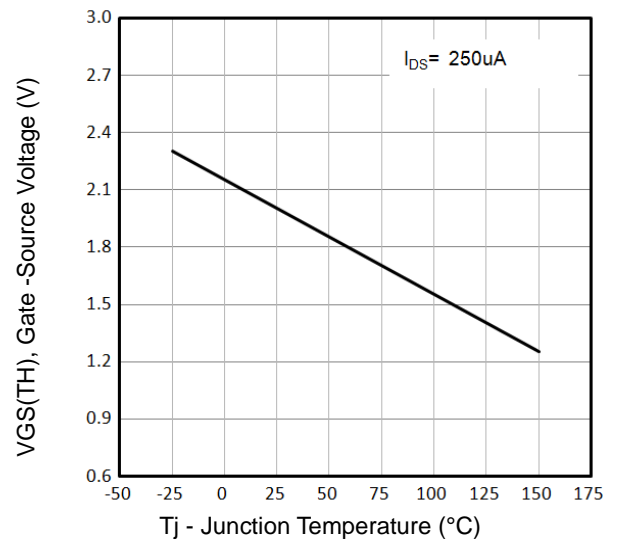

Fig2.  $V_{GS(TH)}$  Gate -Source Voltage Vs.  $T_j$

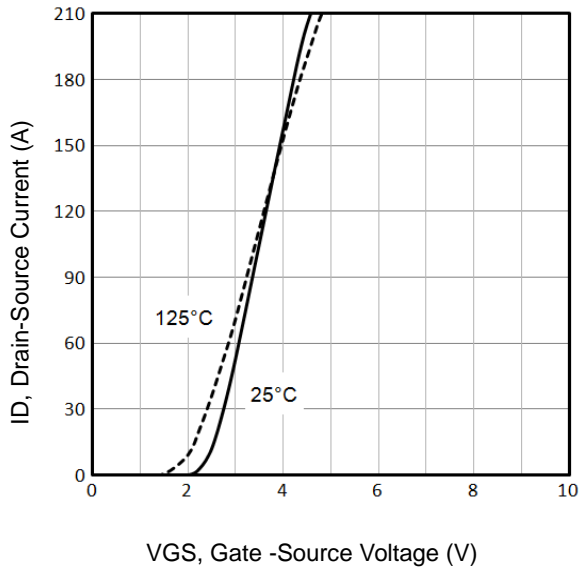

Fig3. Typical Transfer Characteristics

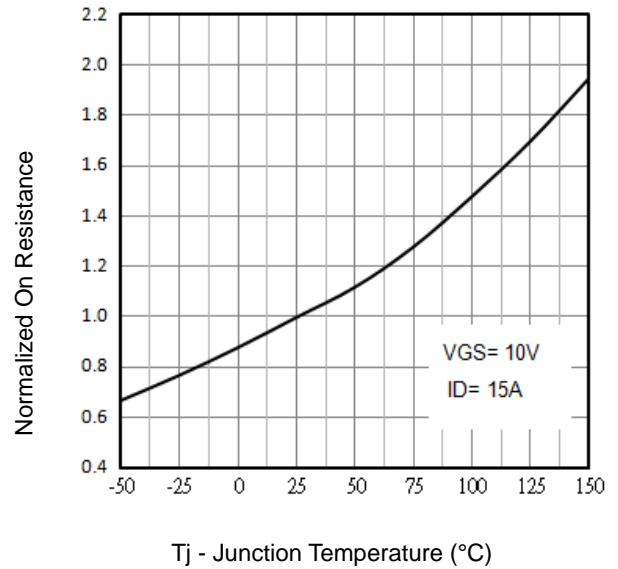

Fig4. Normalized On-Resistance Vs.  $T_j$

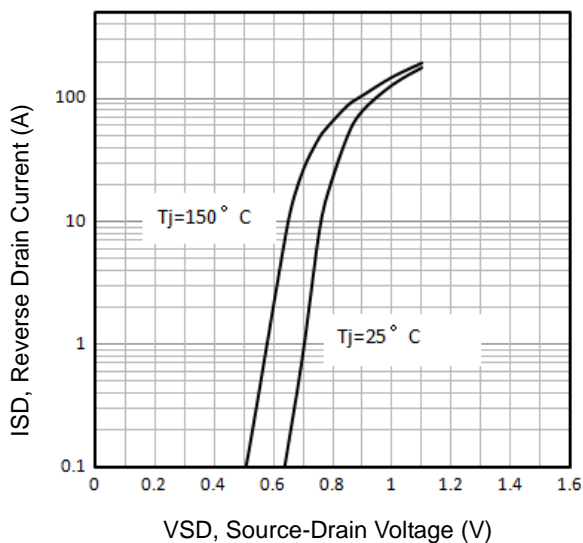

Fig5. Typical Source-Drain Diode Forward Voltage

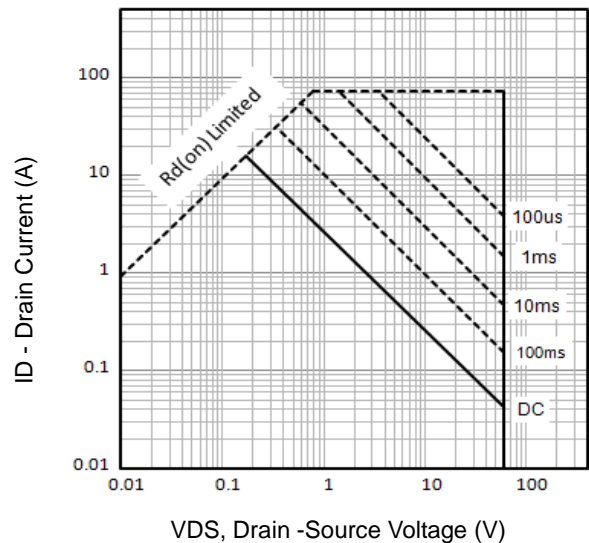

Fig6. Maximum Safe Operating Area

Typical Characteristics

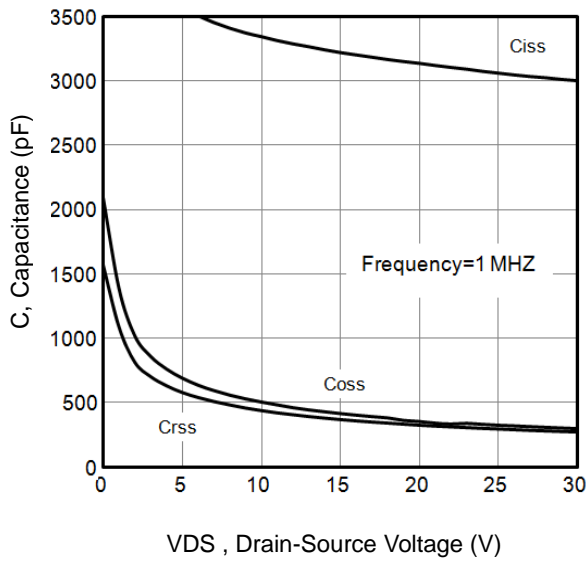

Fig7. Typical Capacitance Vs.Drain-Source Voltage

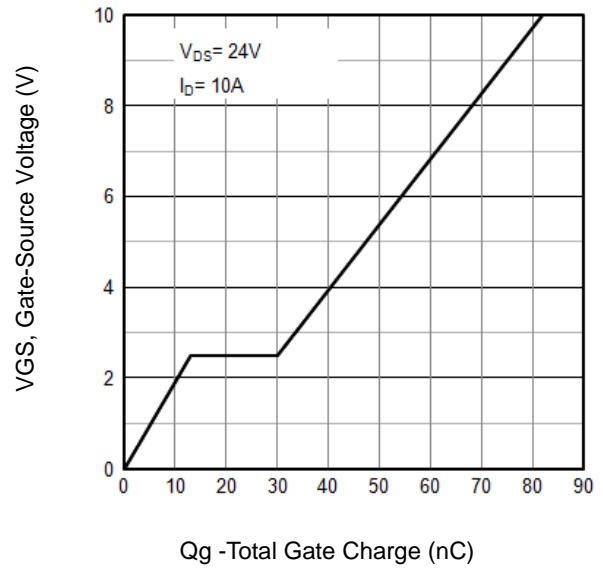

Fig8. Typical Gate Charge Vs.Gate-Source Voltage

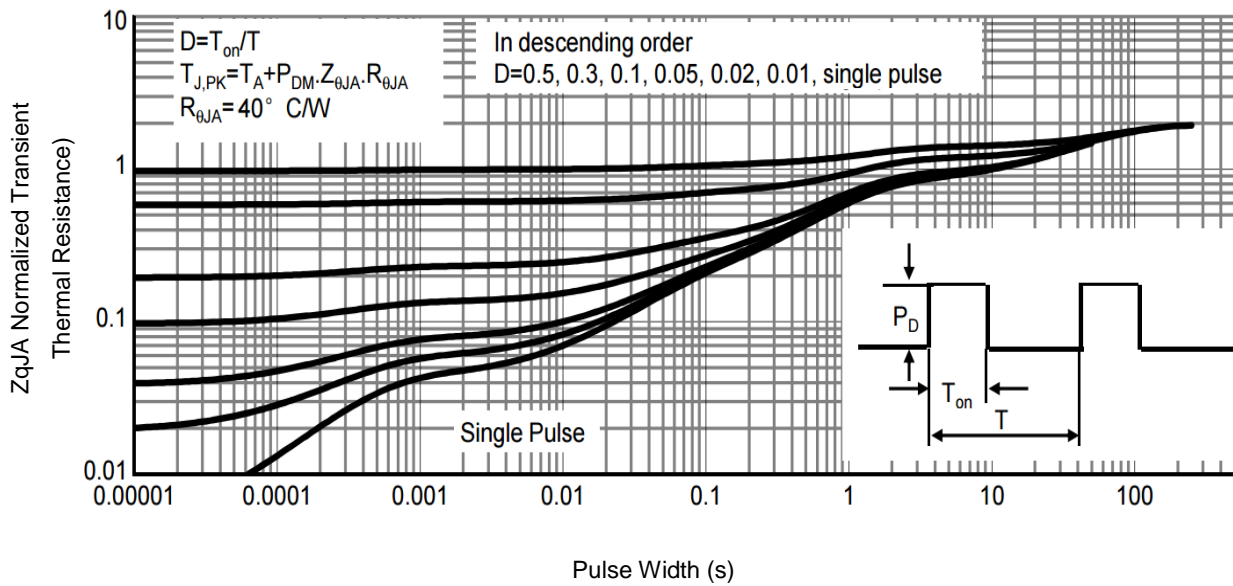

Fig9. Normalized Maximum Transient Thermal Impedance

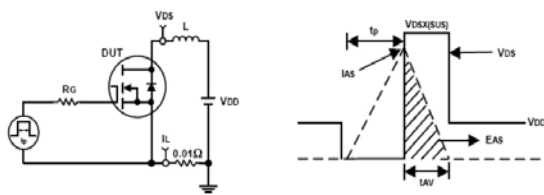

Fig10. Unclamped Inductive Test Circuit and waveforms

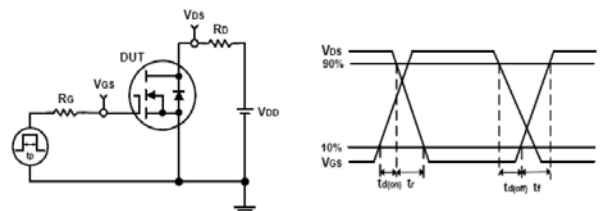
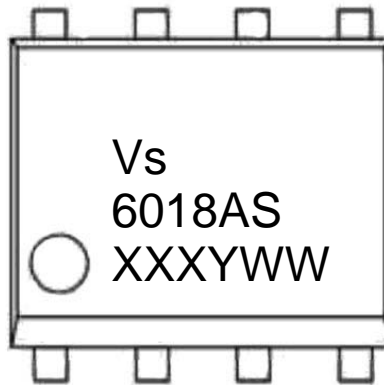

Fig11. Switching Time Test Circuit and waveforms



## Marking Information



1<sup>st</sup> line: Company Code (Vs), Company Logo

2<sup>nd</sup> line: Part Number (6018AS)

3<sup>rd</sup> line: Date code (XXXYWW)

XXX: Wafer Lot Number

Y: Year Code, e.g. E means 2017

WW: Week Code

## SOP8 Package Outline Data

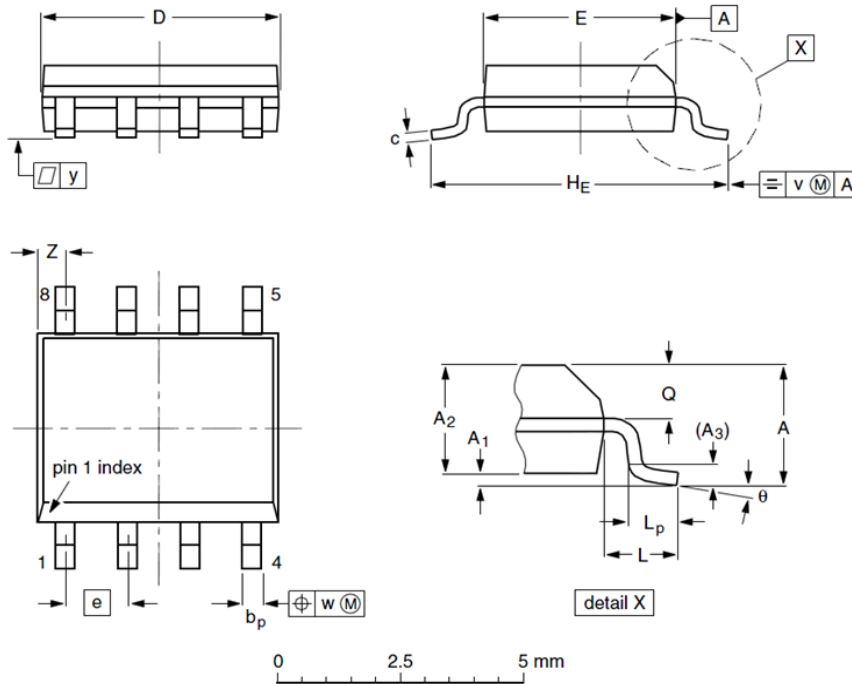

Label	Dimensions (unit: mm)		
	Min	Typ	Max
A	--	--	1.75
A <sub>1</sub>	0.10	0.18	0.25
A <sub>2</sub>	1.25	1.35	1.50
A <sub>3</sub>	--	0.25	--
b <sub>p</sub>	0.36	0.42	0.51
c	0.19	0.22	0.25
D	4.80	4.92	5.00
E	3.80	3.90	4.00
e	--	1.27	--
H <sub>E</sub>	5.80	6.00	6.20
L	--	1.05	--
L <sub>p</sub>	0.40	0.68	1.00
Q	0.60	0.65	0.725
v	--	0.25	--
w	--	0.25	--
y	--	0.10	--
Z	0.30	0.50	0.70
θ	0°		8°

### Notes:

1. Follow JEDEC MS-012.
2. Dimension "D" does NOT include mold flash, protrusions or gate burrs. Mold flash, protrusions or gate burrs shall not exceed 0.15mm per side.
3. Dimension "E" does NOT include interlead flash or protrusion. Interlead flash or protrusion shall not exceed 0.25mm per side.
4. Dimension "b<sub>p</sub>" does NOT include dambar protrusion. Allowable dambar protrusion shall be 0.1mm total in excess of "b<sub>p</sub>" dimension at maximum material condition. The dambar cannot be located on the lower radius of the foot.

## Customer Service

### Sales and Service:

[sales@vgsemi.com](mailto:sales@vgsemi.com)

**Vanguard Semiconductor CO., LTD**

**TEL:** (86-755) -26902410

**FAX:** (86-755) -26907027

**WEB:** [www.vgsemi.com](http://www.vgsemi.com)