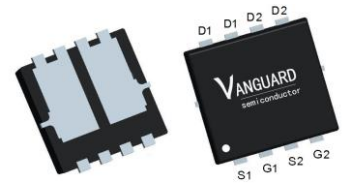

Features

- Dual N-Channel, 5V Logic Level Control
- Enhancement mode
- Low on-resistance $R_{DS(on)}$ @ $V_{GS}=4.5\text{ V}$
- Fast Switching
- 100% Avalanche Tested
- Pb-free lead plating; RoHS compliant

V_{DS}	30	V
$R_{DS(on),TYP} @ V_{GS}=10\text{ V}$	10	m Ω
$R_{DS(on),TYP} @ V_{GS}=4.5\text{ V}$	14	m Ω
I_D	35	A

PDFN3333

Part ID	Package Type	Marking	Tape and reel information
VS3622DE	PDFN3333	3622DE	5000pcs/Reel

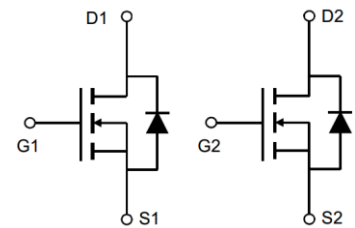

Maximum ratings, at $T_j=25\text{ }^\circ\text{C}$, unless otherwise specified

Symbol	Parameter	Rating	Unit
$V_{(BR)DSS}$	Drain-Source breakdown voltage	30	V
I_S	Diode continuous forward current	$T_C=25\text{ }^\circ\text{C}$	35 A
I_D	Continuous drain current @ $V_{GS}=10\text{ V}$	$T_C=25\text{ }^\circ\text{C}$	35 A
		$T_C=100\text{ }^\circ\text{C}$	22 A
I_{DM}	Pulse drain current tested ①	$T_C=25\text{ }^\circ\text{C}$	140 A
EAS	Avalanche energy, single pulsed ②	16	mJ
P_D	Maximum power dissipation	$T_C=25\text{ }^\circ\text{C}$	20 W
V_{GS}	Gate-Source voltage	± 20	V
T_{STG}	Storage temperature range	-55 to 150	$^\circ\text{C}$

Thermal Characteristics

Symbol	Parameter	Typical	Unit
$R_{\theta JC}$	Thermal Resistance-Junction to Case	6.2	$^\circ\text{C/W}$
$R_{\theta JA}$	Thermal Resistance-Junction to Ambient	45	$^\circ\text{C/W}$

Typical Electrical Characteristics

Symbol	Parameter	Condition	Min.	Typ.	Max.	Unit
Static Electrical Characteristics @ T_J = 25°C (unless otherwise stated)						
V _{(BR)DSS}	Drain-Source Breakdown Voltage	V _{GS} =0V, I _D =250μA	30	--	--	V
I _{DSS}	Zero Gate Voltage Drain Current(Tc=25°C)	V _{DS} =30V, V _{GS} =0V	--	--	1	μA
	Zero Gate Voltage Drain Current(Tc=125°C)	V _{DS} =30V, V _{GS} =0V	--	--	100	μA
I _{GSS}	Gate-Body Leakage Current	V _{GS} =±20V, V _{DS} =0V	--	--	±100	nA
V _{GS(TH)}	Gate Threshold Voltage	V _{DS} =V _{GS} , I _D =250μA	1.3	1.9	2.4	V
R _{DS(ON)}	Drain-Source On-State Resistance ③	V _{GS} =10V, I _D =20A	--	10	13	mΩ
R _{DS(ON)}	Drain-Source On-State Resistance ③	V _{GS} =4.5V, I _D =10A	--	14	18	mΩ
Dynamic Electrical Characteristics @ T_J = 25°C (unless otherwise stated)						
C _{iss}	Input Capacitance	V _{DS} =15V, V _{GS} =0V, f=1MHz	800	880	950	pF
C _{oss}	Output Capacitance		120	140	160	pF
C _{rss}	Reverse Transfer Capacitance		90	110	130	pF
R _g	Gate Resistance	f=1MHz	--	3.5	--	Ω
Q _g	Total Gate Charge	V _{DS} =15V, I _D =20A, V _{GS} =10V	--	19	--	nC
Q _{gs}	Gate-Source Charge		--	4.3	--	nC
Q _{gd}	Gate-Drain Charge		--	6.5	--	nC
Switching Characteristics						
t _{d(on)}	Turn-on Delay Time	V _{DD} =15V, I _D =20A, R _G =3Ω, V _{GS} =10V	--	6	--	nS
t _r	Turn-on Rise Time		--	5	--	nS
t _{d(off)}	Turn-Off Delay Time		--	25	--	nS
t _f	Turn-Off Fall Time		--	7	--	nS
Source- Drain Diode Characteristics @ T_J = 25°C (unless otherwise stated)						
V _{SD}	Forward on voltage	I _{SD} =20A, V _{GS} =0V	--	0.9	1.2	V
t _{rr}	Reverse Recovery Time	T _J =25°C, I _{sd} =20A, V _{GS} =0V	--	7	--	nS
Q _{rr}	Reverse Recovery Charge	di/dt=500A/μs		6.3		nC

NOTE:

- ① Repetitive rating; pulse width limited by max. junction temperature.
- ② Limited by T_{Jmax}, starting T_J = 25°C, L = 0.5mH, R_G = 25Ω, I_{AS} = 8A, V_{GS} = 10V. Part not recommended for use above this value
- ③ Pulse width ≤ 300μs; duty cycle ≤ 2%.



Typical Characteristics

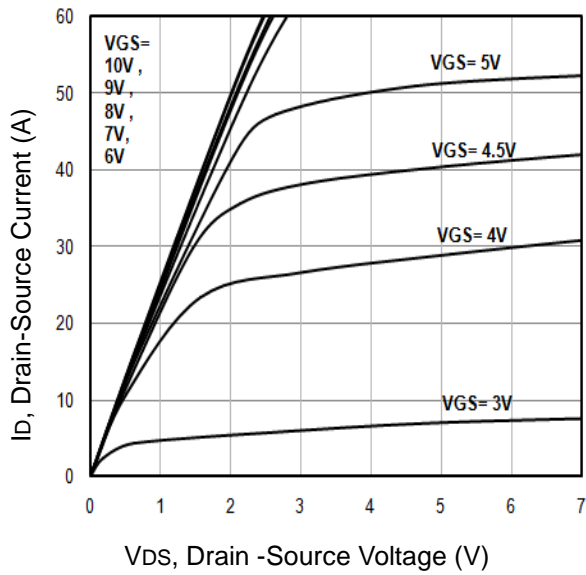

Fig1. Typical Output Characteristics

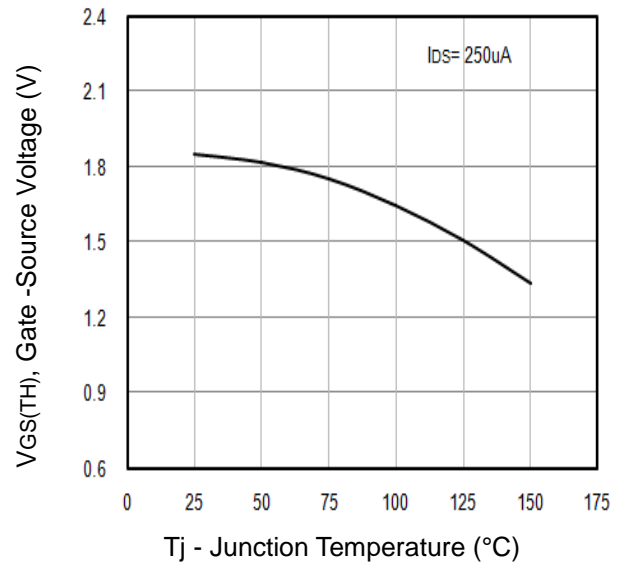

Fig2. Threshold Voltage Vs. Temperature

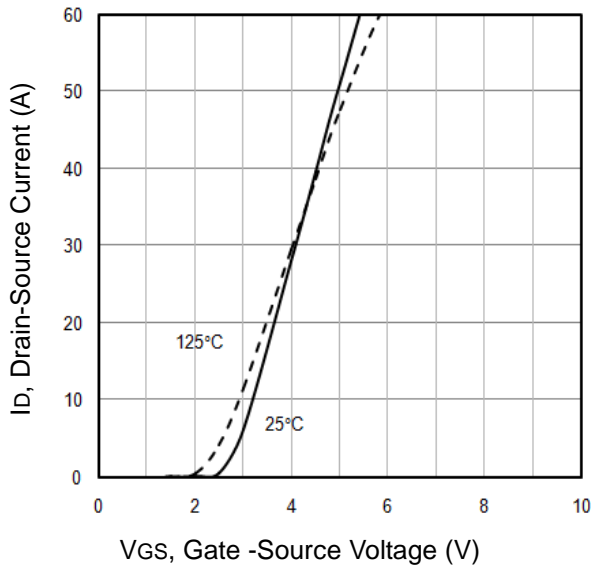

Fig3. Typical Transfer Characteristics

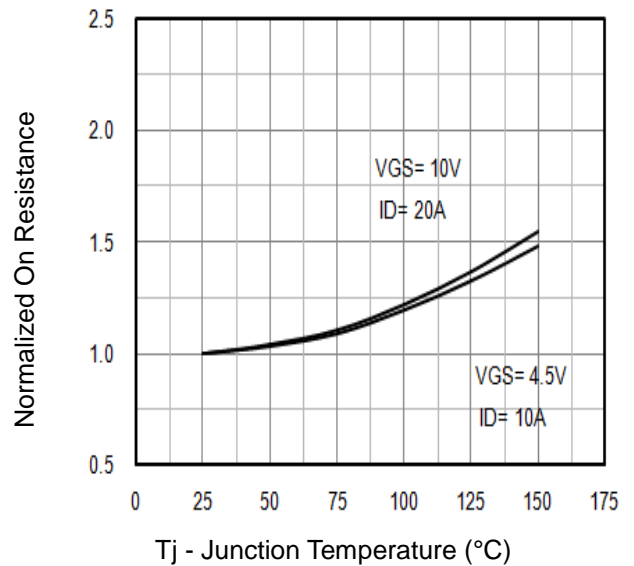

Fig4. Normalized On-Resistance Vs. Temperature

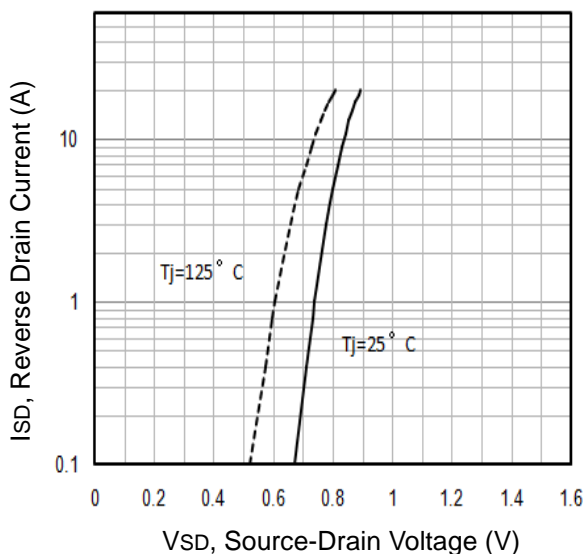

Fig5. Typical Source-Drain Diode Forward Voltage

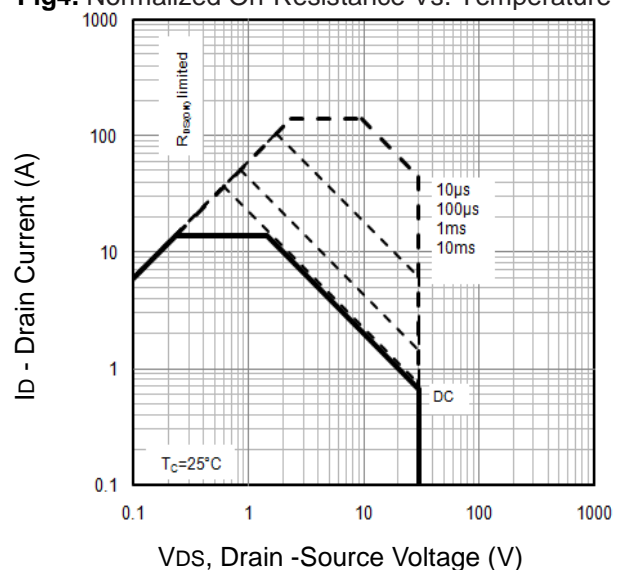

Fig6. Maximum Safe Operating Area

Typical Characteristics

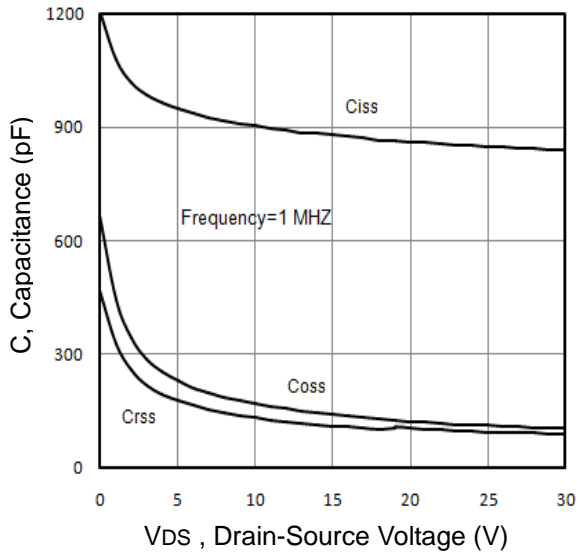

Fig7. Typical Capacitance Vs.Drain-Source Voltage

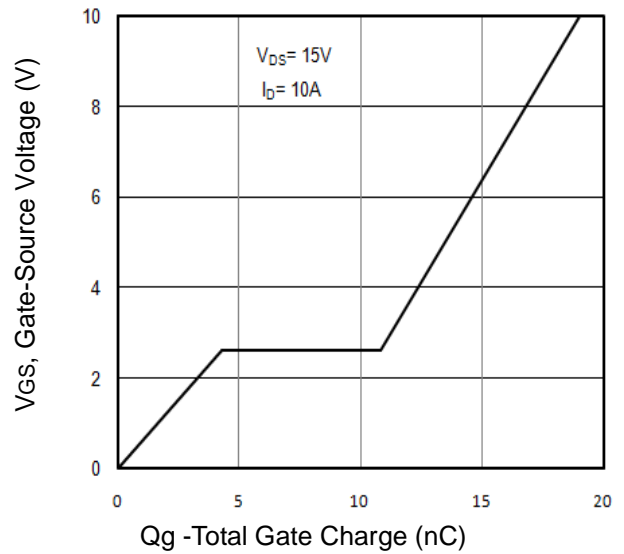

Fig8. Typical Gate Charge Vs.Gate-Source Voltage

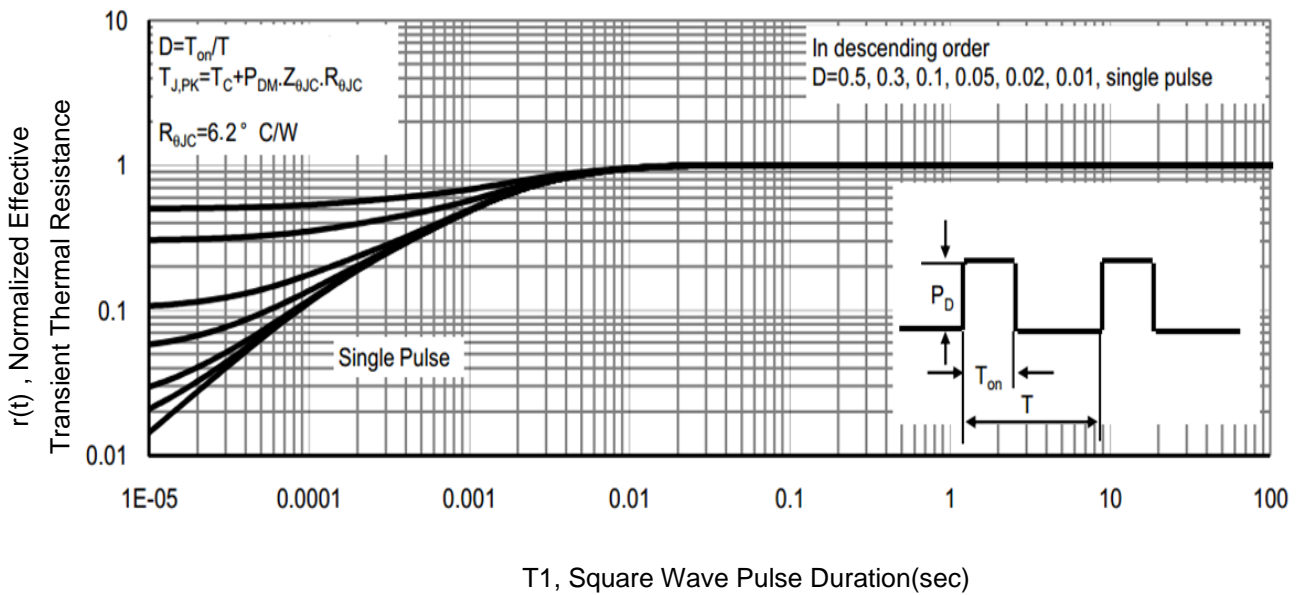

Fig9. T1 ,Transient Thermal Response Curve

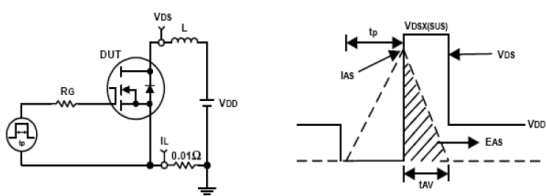

Fig10. Unclamped Inductive Test Circuit and waveforms

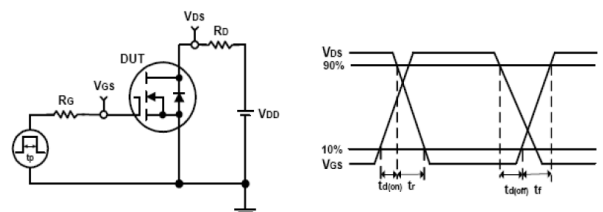
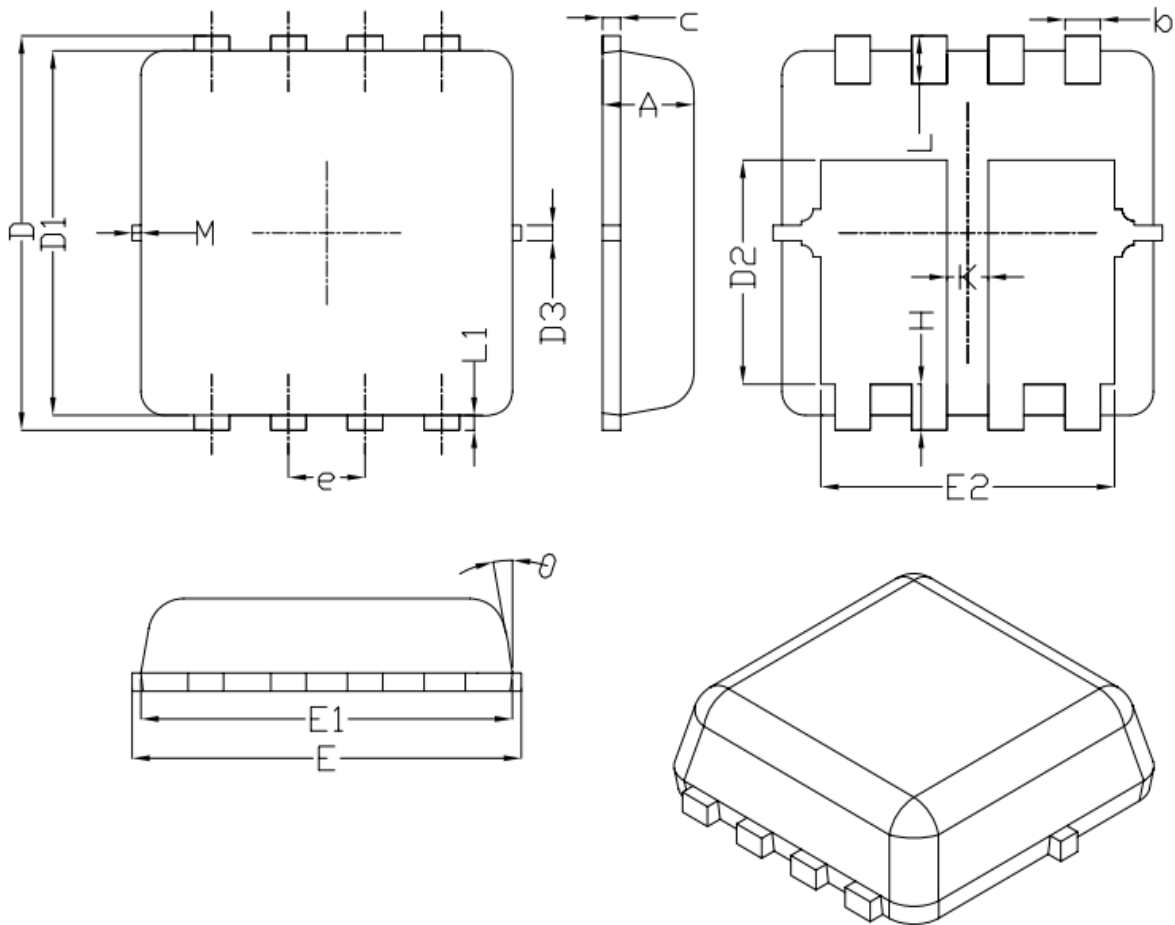

Fig11. Switching Time Test Circuit and waveforms



Dual PDFN3333 Package Outline Data



Symbol	Dimensions (unit: mm)		
	Min	Typ	Max
A	0.70	0.75	0.80
b	0.25	0.30	0.35
c	0.10	0.15	0.25
D	3.25	3.35	3.45
D1	3.00	3.10	3.20
D2	1.78	1.88	1.98
D3	--	0.13	--
E	3.20	3.30	3.40
E1	3.00	3.15	3.20
E2	2.39	2.49	2.59
e	0.65 BSC		
H	0.30	0.39	0.50
L	0.30	0.40	0.50
L1	--	0.13	--
K	0.30	--	--
θ	--	10°	12°
M	*	*	0.15
* Not Specified			

Notes:

1. Refer to JEDEC MO-240 variation CA.
2. Dimensions "D1" and "E1" do NOT include mold flash protrusions or gate burrs.
3. Dimensions "D1" and "E1" include interterminal flash or protrusion. Interterminal flash or protrusion shall not exceed 0.25mm per side.

Customer Service

Sales and Service:

sales@vgsemi.com

Vanguard Semiconductor CO., LTD

TEL: (86-755) -26902410

FAX: (86-755) -26907027

WEB: www.vgsemi.com