

Features

- N-Channel, 2.5V logic level control
- Enhancement mode
- Low on-resistance $R_{DS(on)}$ @ $V_{GS}=2.5\text{ V}$
- Fast Switching and High efficiency
- Pb-free lead plating; RoHS compliant

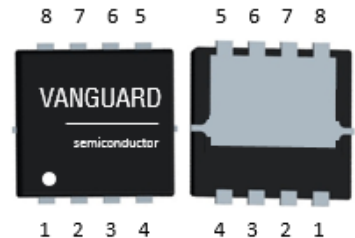

V_{DS}	20	V
$R_{DS(on),TYP} @ V_{GS}=10\text{V}$	4.8	m Ω
$R_{DS(on),TYP} @ V_{GS}=4.5\text{V}$	5.6	m Ω
I_D	56	A

PDFN3333

Part ID	Package Type	Marking	Tape and reel information
VS2622AE	PDFN3333	2622AE	5000pcs/Reel

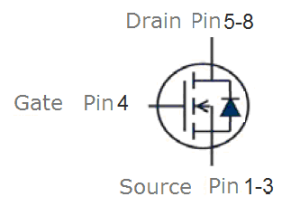

Maximum ratings, at $T_A=25\text{ }^\circ\text{C}$, unless otherwise specified

Symbol	Parameter	Rating	Unit	
$V_{(BR)DSS}$	Drain-Source breakdown voltage	20	V	
V_{GS}	Gate-Source voltage	± 12	V	
I_S	Diode continuous forward current	$T_A=25\text{ }^\circ\text{C}$	56	A
I_D	Continuous drain current @ $V_{GS}=4.5\text{V}$	$T_C=25\text{ }^\circ\text{C}$	56	A
		$T_C=100\text{ }^\circ\text{C}$	35	A
I_{DM}	Pulse drain current tested ①	$T_C=25\text{ }^\circ\text{C}$	220	A
I_{DSM}	Continuous drain current @ $V_{GS}=4.5\text{V}$	$T_A=25\text{ }^\circ\text{C}$	20	A
		$T_A=70\text{ }^\circ\text{C}$	16	A
EAS	Avalanche energy, single pulsed ②		33	mJ
P_D	Maximum power dissipation	$T_C=25\text{ }^\circ\text{C}$	29	W
P_{DSM}	Maximum power dissipation ③	$T_A=25\text{ }^\circ\text{C}$	3.6	W
T_{STG}, T_J	Storage and junction temperature range		-55 to 150	$^\circ\text{C}$

Thermal Characteristics

Symbol	Parameter	Typical	Unit
$R_{\theta JC}$	Thermal Resistance, Junction-to-Case	4.3	$^\circ\text{C/W}$
$R_{\theta JA}$	Thermal Resistance, Junction-to-Ambient	35	$^\circ\text{C/W}$

Electrical Characteristics

Symbol	Parameter	Condition	Min.	Typ.	Max.	Unit
Static Electrical Characteristics @ T_j = 25°C (unless otherwise stated)						
V _{(BR)DSS}	Drain-Source Breakdown Voltage	V _{GS} =0V, I _D =250μA	20	--	--	V
I _{DSS}	Zero Gate Voltage Drain Current(T _j =25°C)	V _{DS} =20V, V _{GS} =0V	--	--	1	μA
	Zero Gate Voltage Drain Current(T _j =125°C)	V _{DS} =20V, V _{GS} =0V	--	--	100	μA
I _{GSS}	Gate-Body Leakage Current	V _{GS} =±12V, V _{DS} =0V	--	--	±100	nA
V _{GS(TH)}	Gate Threshold Voltage	V _{DS} =V _{GS} , I _D =250μA	0.4	0.7	1	V
R _{DS(ON)}	Drain-Source On-State Resistance ④	V _{GS} =10V, I _D =15A	--	4.8	6.7	mΩ
R _{DS(ON)}	Drain-Source On-State Resistance ④	V _{GS} =4.5V, I _D =10A	--	5.6	7.8	mΩ
R _{DS(ON)}	Drain-Source On-State Resistance ④	V _{GS} =2.5V, I _D =4A	--	7.7	10.8	mΩ
Dynamic Electrical Characteristics @ T_j = 25°C (unless otherwise stated)						
C _{iss}	Input Capacitance	V _{DS} =10V, V _{GS} =0V, f=1MHz	1040	1290	1540	pF
C _{oss}	Output Capacitance		130	200	270	pF
C _{rss}	Reverse Transfer Capacitance		120	180	240	pF
R _g	Gate Resistance	f=1MHz	--	2.5	--	Ω
Q _g	Total Gate Charge	V _{DS} =10V, I _D =10A, V _{GS} =4.5V	--	18	--	nC
Q _{gs}	Gate-Source Charge		--	7.5	--	nC
Q _{gd}	Gate-Drain Charge		--	8.5	--	nC
Switching Characteristics						
t _{d(on)}	Turn-on Delay Time	V _{DD} =10V, I _D =10A, R _G =3Ω, V _{GS} =4.5V	--	3.1	--	μs
t _r	Turn-on Rise Time		--	4.6	--	μs
t _{d(off)}	Turn-Off Delay Time		--	9	--	μs
t _f	Turn-Off Fall Time		--	9.4	--	μs
Source- Drain Diode Characteristics @ T_j = 25°C (unless otherwise stated)						
V _{SD}	Forward on voltage	I _{SD} =10A, V _{GS} =0V	--	0.8	1.2	V
t _{rr}	Reverse Recovery Time	T _j =25°C, I _{sd} =10A, V _{GS} =0V	--	13	--	ns
Q _{rr}	Reverse Recovery Charge	di/dt=500A/μs	--	17	--	nC

NOTE:

- ① Repetitive rating; pulse width limited by max junction temperature.
- ② Limited by T_{Jmax}, starting T_J = 25°C, L = 0.1mH, R_G = 25Ω, I_{AS} = 20A, V_{GS} = 4.5V. Part not recommended for use above this value
- ③ The power dissipation P_{DSM} is based on R_{θJA} and the maximum allowed junction temperature of 150°C.
- ④ Pulse width ≤ 300μs; duty cycle ≤ 2%.

Typical Characteristics

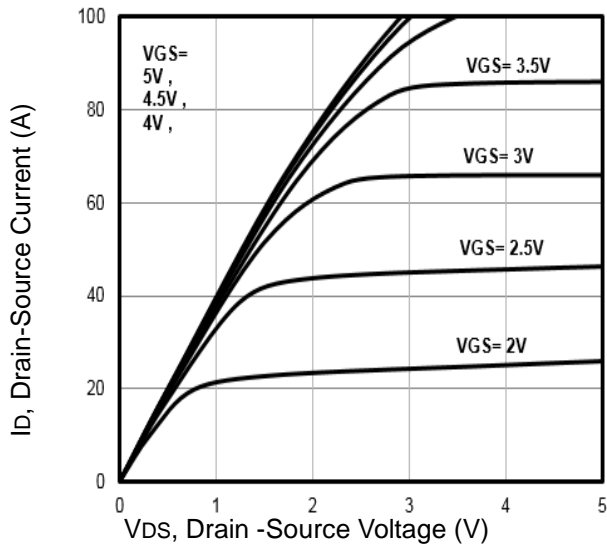

Fig1. Typical Output Characteristics

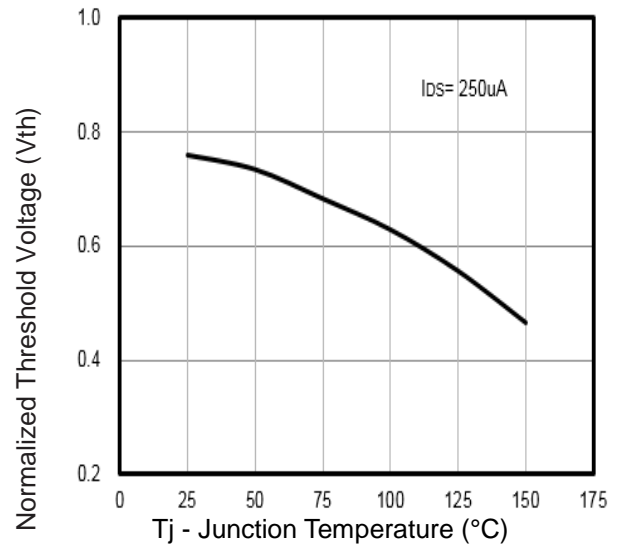

Fig2. Normalized Threshold Voltage Vs. Temperature

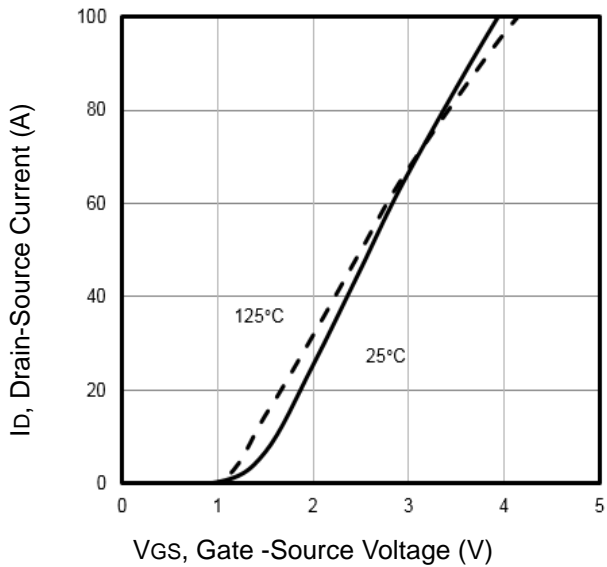

Fig3. Typical Transfer Characteristics

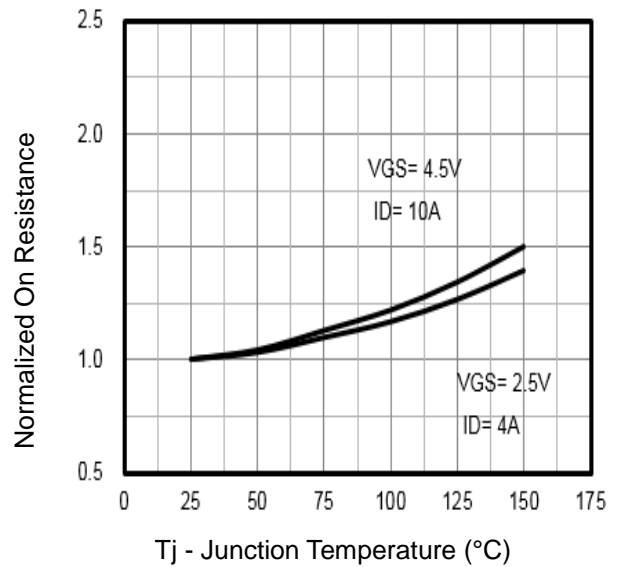

Fig4. Normalized On-Resistance Vs. Temperature

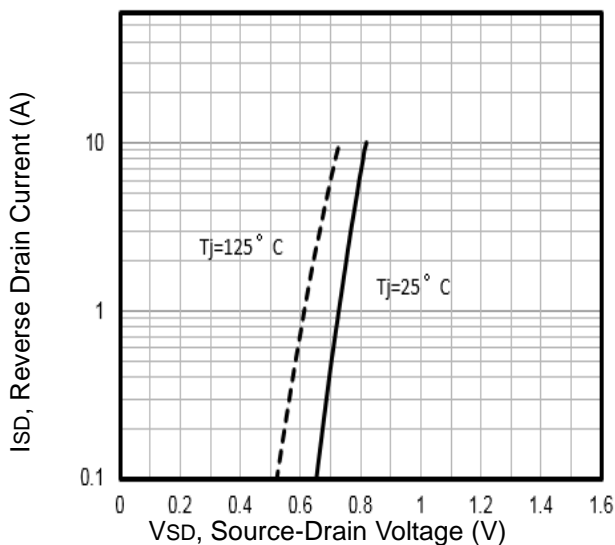

Fig5. Typical Source-Drain Diode Forward Voltage

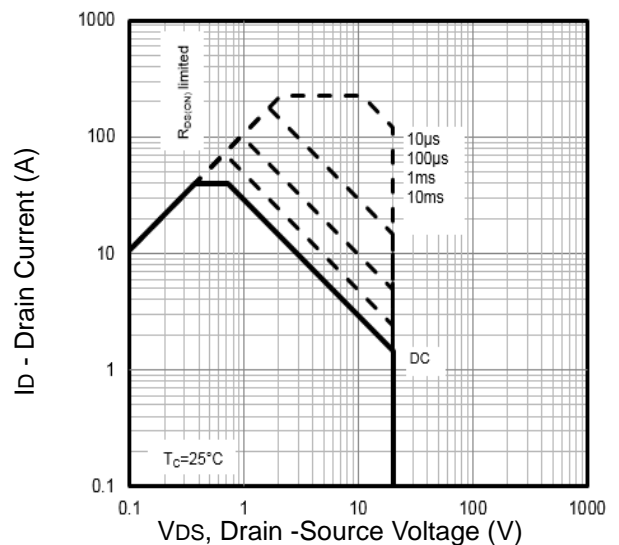

Fig6. Maximum Safe Operating Area

Typical Characteristics

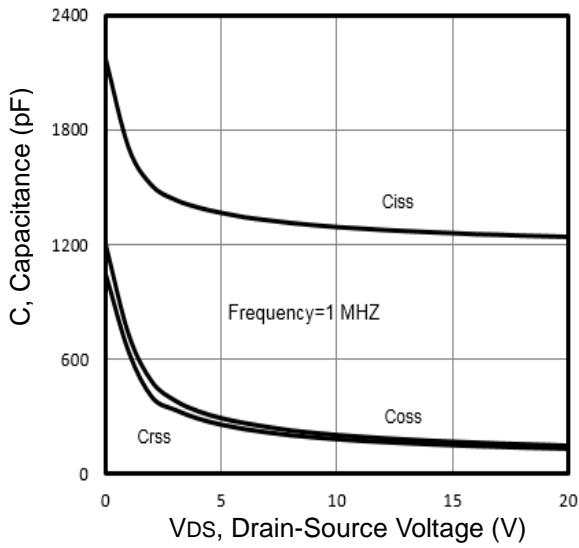

Fig7. Typical Capacitance Vs. Drain-Source Voltage

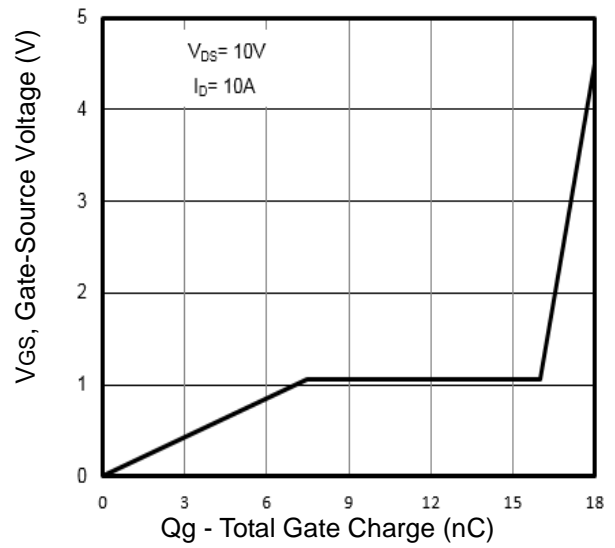

Fig8. Typical Gate Charge Vs. Gate-Source

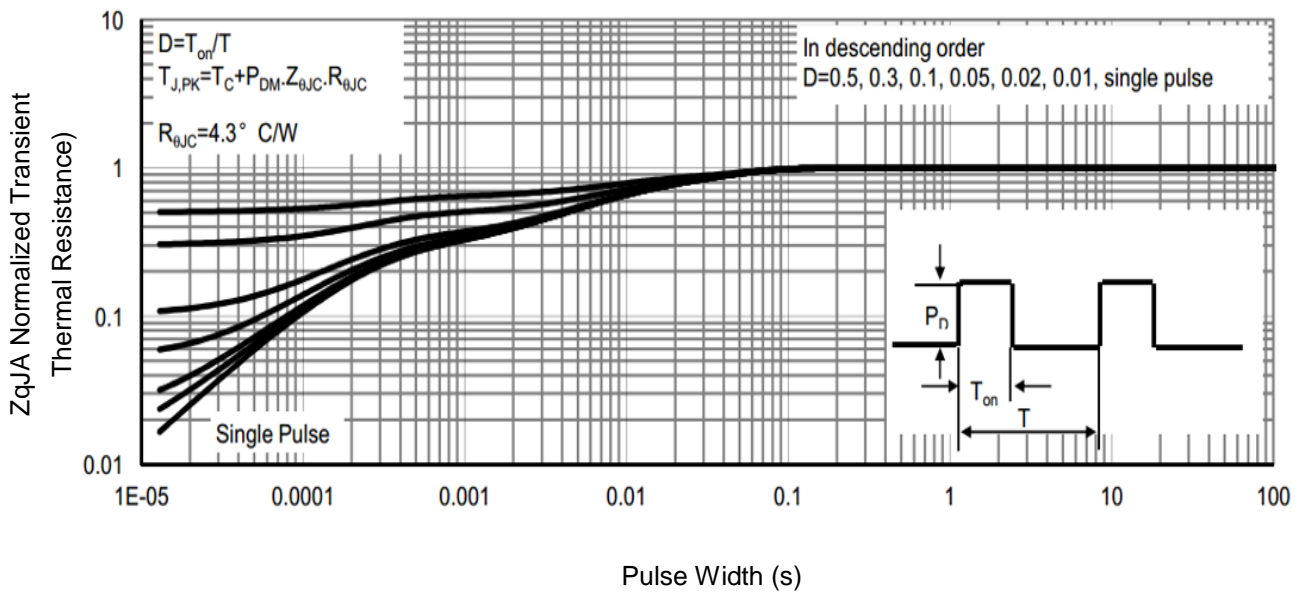

Fig9. Normalized Maximum Transient Thermal Impedance

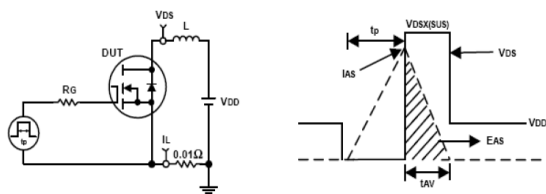

Fig10. Unclamped Inductive Test Circuit and waveforms

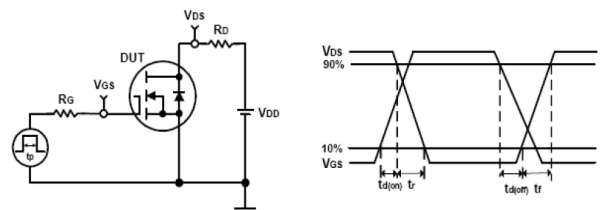
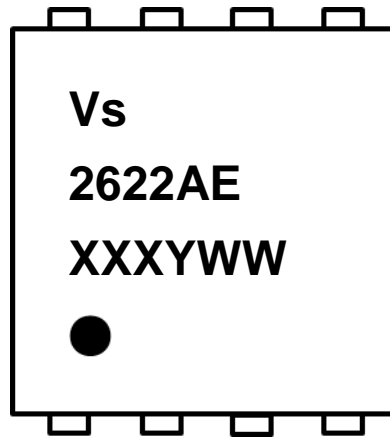

Fig11. Switching Time Test Circuit and waveforms



Marking Information



1st line: Vanguard Code (Vs)

2nd line: Part Number (2622AE)

3rd line: Date code (XXXYWW)

XXX: Wafer Lot Number Code , code changed with Lot Number

Y: Year Code, (e.g. E=2017, F=2018, G=2019, H=2020, etc)

WW: Week Code (01 to 53)

Dot: Pin1 identification

PDFN3333 Package Outline Data

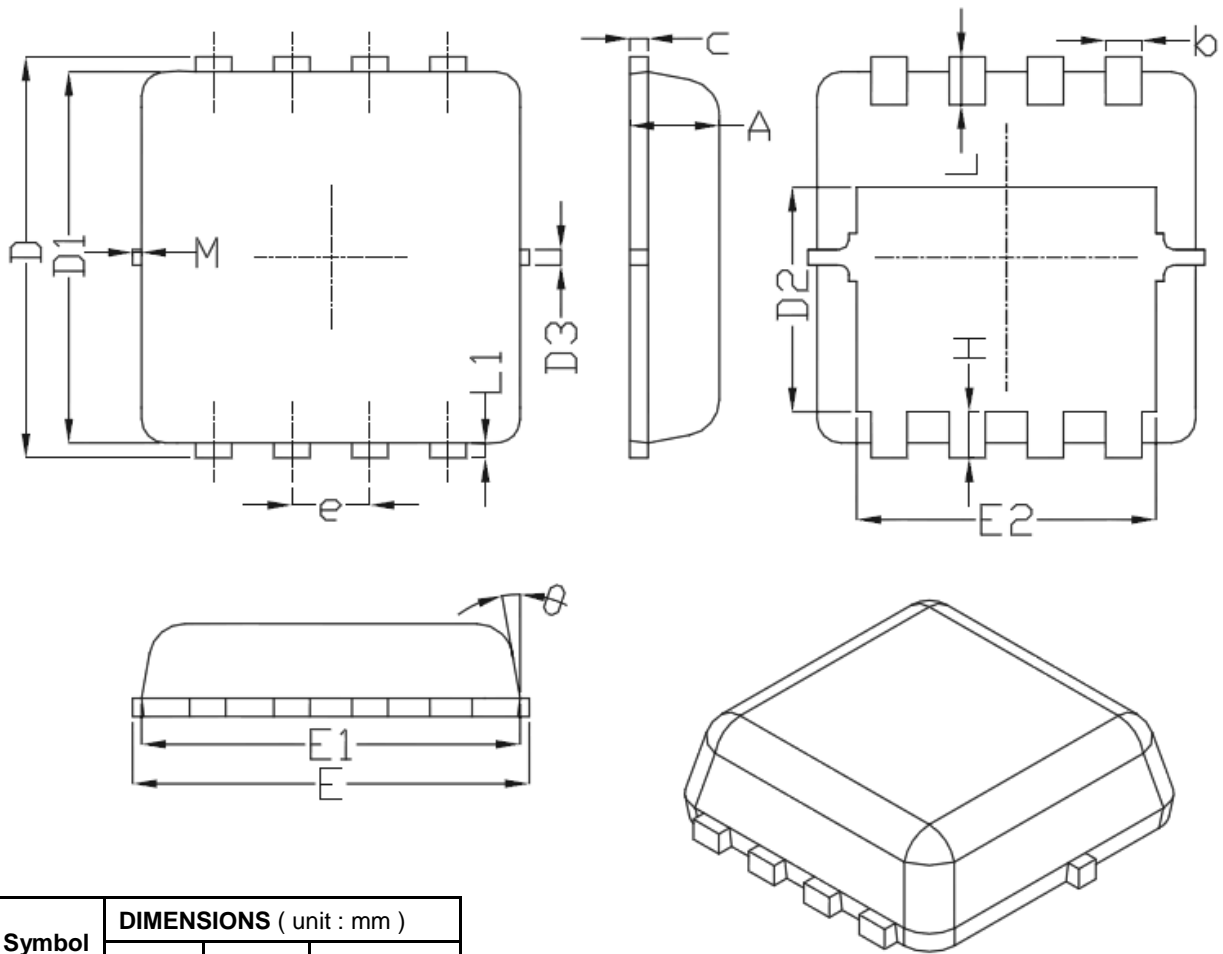

Symbol	DIMENSIONS (unit : mm)		
	Min	Typ	Max
A	0.7	0.75	0.8
b	0.25	0.3	0.35
C	0.1	0.15	0.25
D	3.25	3.35	3.45
D1	3	3.1	3.2
D2	1.78	1.88	1.98
D3	--	0.13	--
E	3.2	3.3	3.4
E1	3	3.15	3.2
E2	2.39	2.49	2.59
e	0.65 BSC		
H	0.3	0.39	0.5
L	0.3	0.4	0.5
L1	--	0.13	--
θ	--	10°	12°
M	*	*	0.15
* Not specified			

Notes:

1. Follow JEDEC MO-240 variation CA.
2. Dimensions "D1" and "E1" do NOT include mold flash protrusions or gate burrs.
3. Dimensions "D1" and "E1" include interterminal flash or protrusion. Interterminal flash or protrusion shall not exceed 0.25mm per side.

Customer Service

Sales and Service:

sales@vgsemi.com

Vanguard Semiconductor CO., LTD

TEL: (86-755) -26902410

FAX: (86-755) -26907027

WEB: www.vgsemi.com