



M54123L

LINEAR INTEGRATED CIRCUIT

EARTH LEAKAGE CURRENT DETECTOR

■ DESCRIPTION

The UTC **M54123L** is a semiconductor integrated circuit with amplifier for a high-speed earth leakage circuit breaker.

For the amplifying parts of earth leakage circuit breaker, the UTC **M54123L** consists of differential amplifier, latch circuit and voltage regulator.

In normal operating, the UTC **M54123L** should be connected to the secondary side of the ZCT (zero current transformers). Here the ZCT detects leakage current different amplifiers' both input.

Then the signals which have been amplified are integrated by an external capacitor. The integrated signal connects to the input terminal of latch circuit whose output is suitable for the characteristics of high- speed earth leakage circuit breaker.

Until the input voltage reaches the fixed level, latch circuit doesn't become high. Then drives a thyristor which is connected to latch circuit's output terminal. Once the trigger latch circuit, only the power on again to reset.

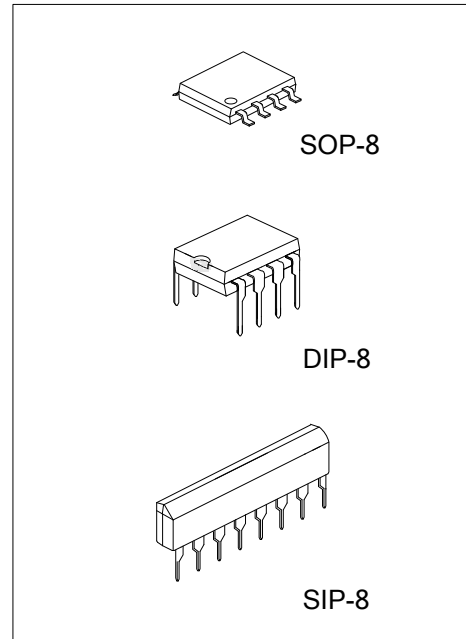

■ FEATURES

- * With good input sensitivity current temperature characteristics
- * High input sensitivity : $V_T=6.1mV$ (Typ.)
- * Only need low external component count
- * High noise and surge-proof
- * Low power dissipation : $P_D=5mW$ (Typ.)
- * May be used both as 100V and 200V.
- * Wide temperature range : from $-20\text{ }^\circ\text{C}$ to $+80\text{ }^\circ\text{C}$

■ ORDERING INFORMATION

Order Number		Package	Packing
Lead Free	Halogen Free		
M54123LK-D08-T	M54123LG-D08-T	DIP-8	Tube
M54123LK-G08-T	M54123LG-G08-T	SIP-8	Tube
-	M54123LG-S08-R	SOP-8	Tape Reel

<p>M54123LK-D08-T</p>	<p>(1)Packing Type (2)Package Type (3)Green Package</p>	<p>(1) T: Tube, R: Tape Reel (2) D08: DIP-8, G08: SIP-8, S08: SOP-8 (3) L: Lead Free, G: Halogen Free and Lead Free</p>
-----------------------	---	---

MARKING

DIP-8	SIP-8	SOP-8
<p>UTC M54123L Date Code L: Lead Free K: Halogen Free Lot Code</p>	<p>UTC M54123LK Date Code L: Lead Free K: Halogen Free Lot Code</p>	<p>UTC M54123LG Date Code Lot Code</p>

PIN CONFIGURATIONS

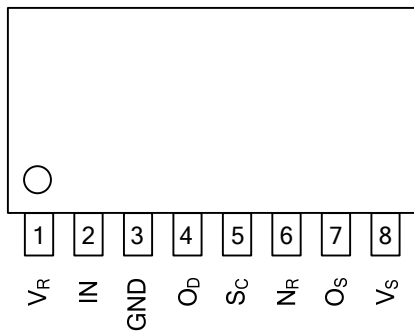

SIP-8

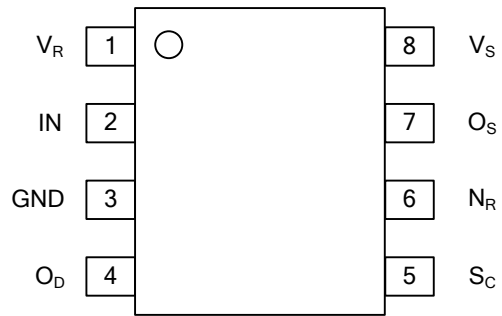

DIP-8 / SOP-8

PIN DESCRIPTION

PIN NO.	PIN NAME	DESCRIPTION
1	V _R	Reference voltage terminal
2	IN	Input terminal
3	GND	Ground
4	O _D	Differential amplifier output terminal
5	S _C	Latch input terminal
6	N _R	Terminal for noise absorption
7	O _S	Output terminal
8	V _S	Supply voltage terminal

■ BLOCK DIAGRAM

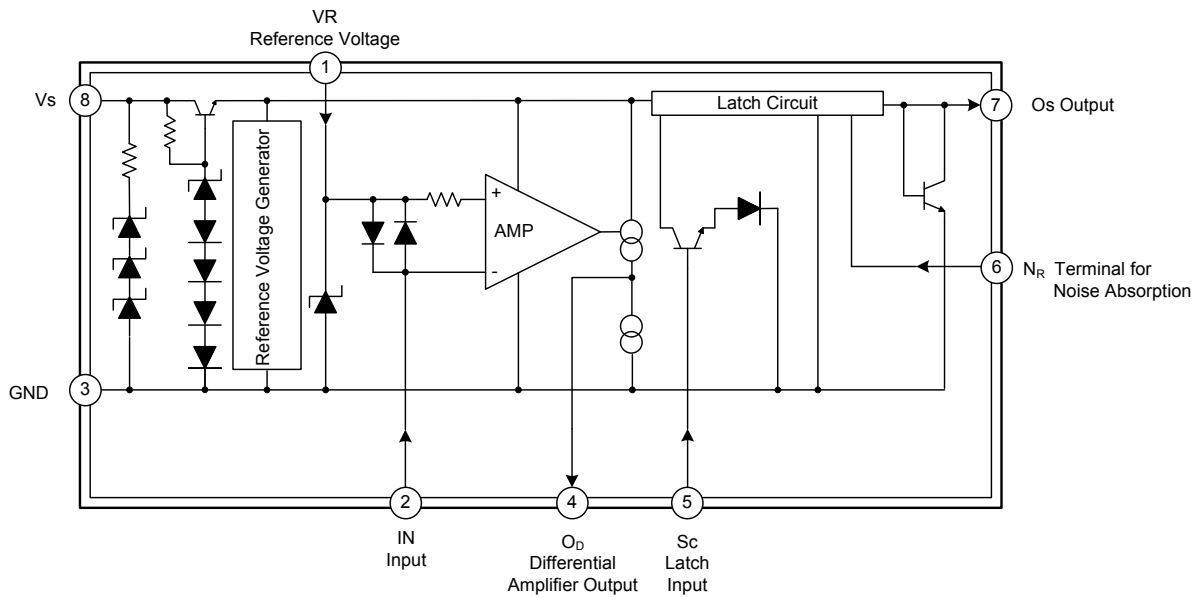

■ ABSOLUTE MAXIMUM RATING (unless otherwise specified)

PARAMETER		SYMBOL	RATINGS	UNIT
Supply Current		I_S	8	mA
V_R Pin Current	Between V_R -IN (Note 2)	I_{VR}	250	mA
	Between V_R -GND		30	mA
	Between IN- V_R (Note 2)		-250	mA
IN Terminal Current	Between IN- V_R (Note 2)	I_{IN}	250	mA
	Between IN-GND		30	mA
	Between V_R -IN (Note 2)		-250	mA
S_C Terminal Current		I_{SC}	5	mA
Power Dissipation		P_D	200	mW
Operating Temperature		T_{OPR}	-20~ +80	°C
Storage Temperature		T_{STG}	-55~ +125	°C

Notes: 1. Absolute maximum ratings are those values beyond which the device could be permanently damaged.

Absolute maximum ratings are stress ratings only and functional device operation is not implied.

2. Current value between V_R and IN, and between IN and V_R is less than 1ms in the pulse width, and duty cycle is less than 12%, In applying AC current continuously, it is 100 mA in the off-state.

■ RECOMMENDED OPERATING CONDITIONS (unless otherwise specified)

PARAMETER	SYMBOL	MIN	TYP	MAX	UNIT
Supply Voltage When Latch Circuit Is Off-State	V_S	12			V
External Capacitor Between V_S and GND	C_{VS}	1			μF
External Capacitor Between O_S and GND	C_{OS}			1	μF

■ ELECTRICAL CHARACTERISTICS ($T_A=-20\sim+80^\circ\text{C}$, unless otherwise specified)

PARAMETER	SYMBOL	TEST CONDITIONS	MIN	TYP	MAX	UNIT	
Supply Current	I_{S1}	$V_S=12\text{V}, V_R-V_I=30\text{mV}$ (See Test Circuit 1)	$T_A=-20^\circ\text{C}$		580	μA	
			$T_A=25^\circ\text{C}$		400	530	μA
			$T_A=80^\circ\text{C}$			480	μA
Trip Voltage	V_T	$V_S=16\text{V}, V_R-V_I, T_A=-20\sim+80^\circ\text{C}$ (Note2) (See Test Circuit 2)	4	6.1	9	mVrms	
Timed Current1	I_{TD1}	$V_S=16\text{V}, V_R-V_I=30\text{mV}, V_{OD}=1.2\text{V}, T_A=25^\circ\text{C}$ (See Test Circuit 3)	-12		-30	μA	
Timed Current2	I_{TD2}	$V_S=16\text{V}$, short circuit between V_R and V_I , $V_{OD}=0.8\text{V}, T_A=25^\circ\text{C}$ (See Test Circuit 4)	17		37	μA	
Output Current	I_O	$V_{SC}=1.4\text{V}, V_{OS}=0.8\text{V}$ (See Test Circuit 5)	$I_{S1}=580\mu\text{A}, T_A=-20^\circ\text{C}$	-200			μA
			$I_{S1}=530\mu\text{A}, T_A=25^\circ\text{C}$	-100			μA
			$I_{S1}=480\mu\text{A}, T_A=80^\circ\text{C}$	-75			μA
S_C "ON" Voltage (Note3)	$V_{SC(ON)}$	$V_S=16\text{V}, T_A=25^\circ\text{C}$ (See Test Circuit 6)	0.7		1.4	V	
S_C Input Current	$I_{SC(ON)}$	$V_S=12\text{V}, T_A=25^\circ\text{C}$ (See Test Circuit 7)			5	μA	
Output Low-Level Current	I_{OSL}	$V_S=12\text{V}, V_{OSL}=0.2\text{V}, T_A=-20\sim+80^\circ\text{C}$ (See Test Circuit 8)	200			μA	
Input Clamp Voltage	V_{IC}	$V_S=12\text{V}, I_{IC}=20\text{mA}, T_A=-20\sim+80^\circ\text{C}$ (See Test Circuit 9)	4.3		6.7	V	
Differential Input Clamp Voltage	V_{IDC}	$I_{IDC}=100\text{mA}, T_A=-20\sim+80^\circ\text{C}$ (See Test Circuit 10)	0.4		2	V	
Maximum Current Voltage	V_{SM}	$I_{SM}=7\text{mA}, T_A=25^\circ\text{C}$ (See Test Circuit 11)	20		28	V	
Supply Current 2(Note 4)	I_{S2}	$V_R-V_I, V_{OS}=0.6\text{V}, T_A=-20\sim+80^\circ\text{C}$ (Note 5) (See Test Circuit 12)			1100	μA	
Latch Circuit is Off-State Supply Voltage (Note6)	$V_{S(OFF)}$	$T_A=25^\circ\text{C}$ (See Test Circuit 13)	0.5			V	
Operating Time (Note 7)	T_{ON}	$V_S=16\text{V}, V_R-V_I=0.3\text{V}, T_A=25^\circ\text{C}$ (See Test Circuit 14)	2		4	ms	

■ ELECTRICAL CHARACTERISTICS (Cont.)

Notes: 1. Typical values are at $T_A=25^\circ\text{C}$

2. When standard value of voltage (60Hz) between V_R and V_I is minimum, and output O_S is low-level, or when standard value of voltage (60Hz) between V_R and V_I is maximum, and output O_S is high-level, it is considered as a good one.
3. When standard value of voltage $V_{SC(ON)}$ is minimum, and output O_S is low-level, or when standard value of voltage $V_{SC(ON)}$ is maximum, and output O_S is high-level, it is considered as a good one.
4. Supply current 2 is necessary to keep high in output O_S .
5. After applying 30mV between V_R and V_I and shorting between them, it is considered as a good one if standard value of IGT flows out of output O_S .
6. After supply voltage applies 12V and output O_S is high-level, it is considered as a good one in the standard value of supply voltage and in the low-level of output O_S .
7. Operating time is a time from applying fixed input till operating latch circuit in $0.047\mu\text{F}$ between O_D and GND.

■ TYPICAL APPLICATION CIRCUIT

High-Speed Leakage Circuit Breaker With UTC M54123L

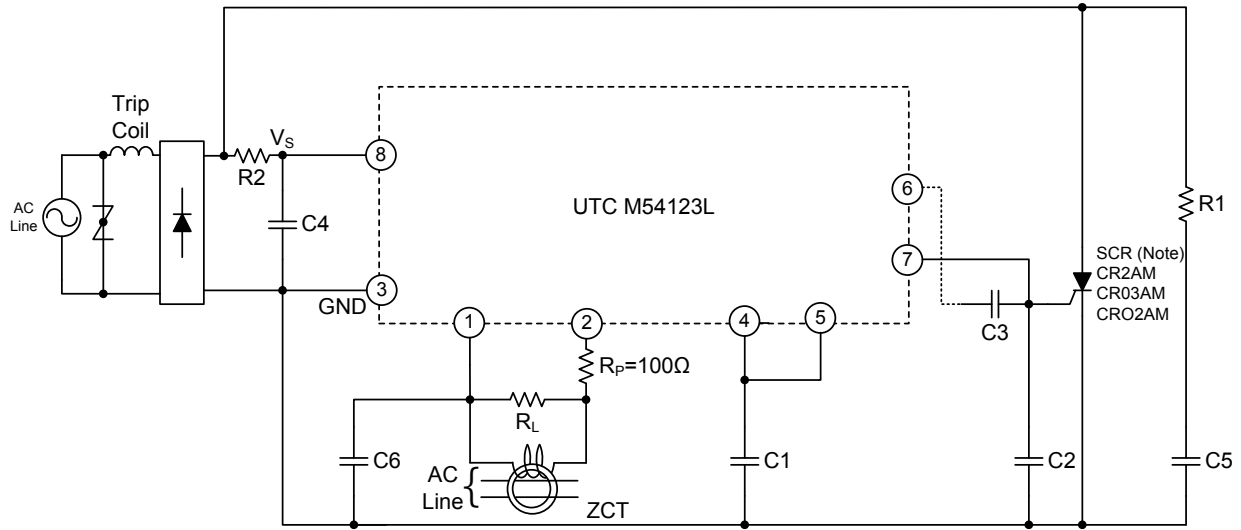

Note: Gate current must be selected.
Please select voltage resistance by AC supply voltage

Note: The value of R1, R2, C4, and C5 should be chosen in order to keep at least 12V in Vs.

Please connect C4 (>1μF) and C2 (<1μF).

ZCT and load resistance R_L of ZCT are connected between input pin 1 and 2.

Protective resistance ($R_P=100\Omega$) must be inserted.

R_L and amplifier's output (in Pin 4) regulates sensitivity current

External capacitor C1 between pin 4 and GND is used for noise removal.

Please connect a varistor or a diode (2 pcs.) to ZCT in parallel, because of when large current is grounded in the primary side (AC line) of ZCT, the following situation can be abandoned: The wave form in the secondary side of ZCT is distorted and some signals do not appear in the output of amplifier.

Please connect capacitor (about 0.047μF) between pin 6 and pin 7.

Capacitor C6 between pin 1 and GND is about 0.047μF for removing noise.

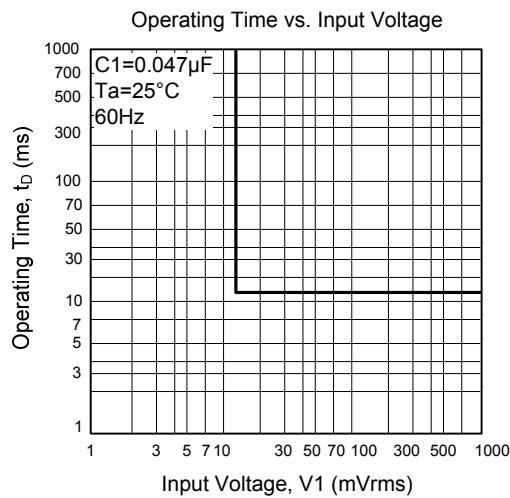

TYPICAL CHARACTERISTICS

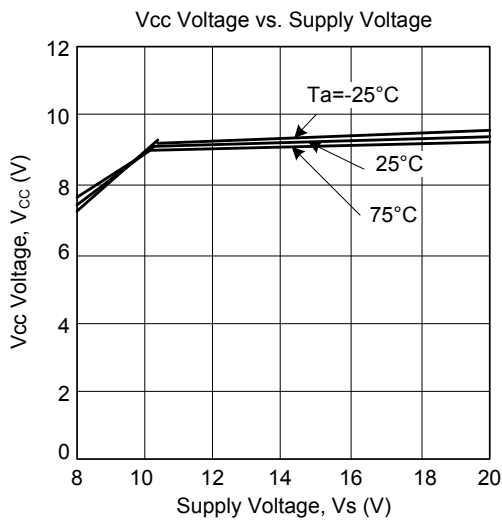

Vcc voltage generates by the constant voltage circuit in IC. This is measured not by M54123L but by a special element.

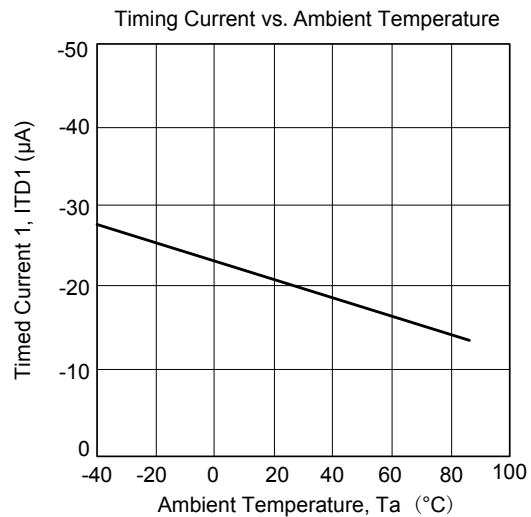
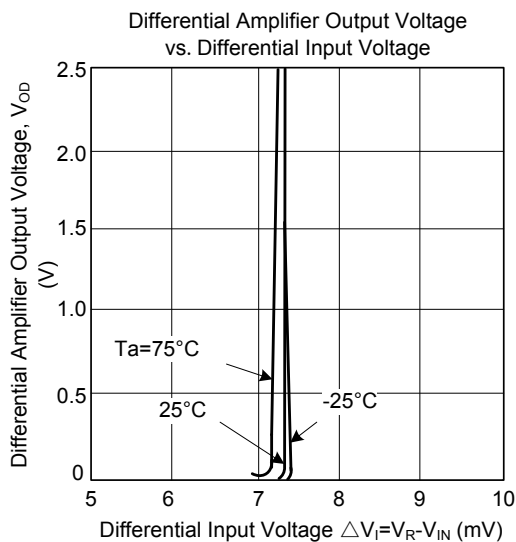
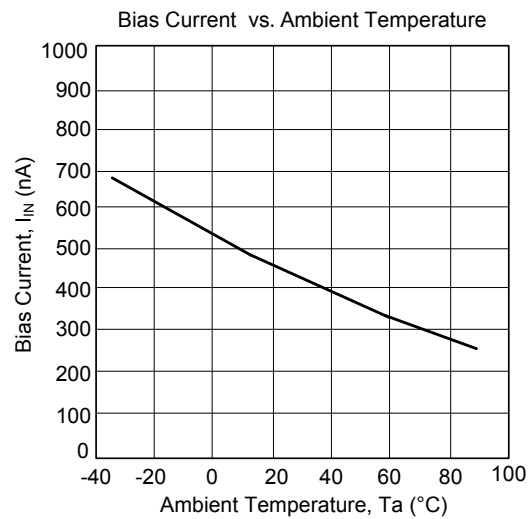
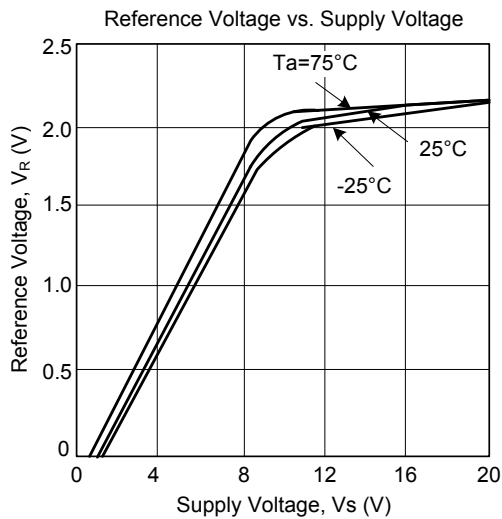
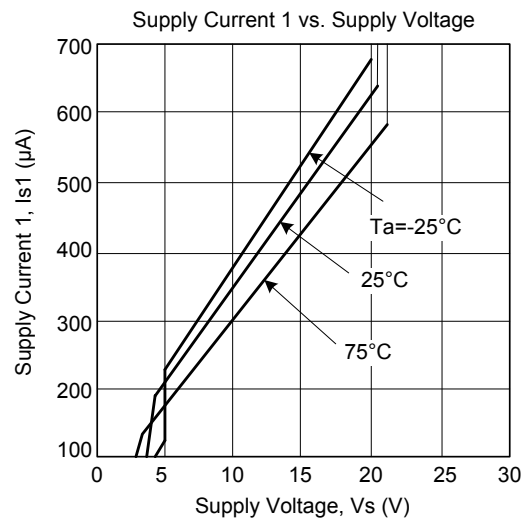

■ TYPICAL CHARACTERISTICS(Cont.)

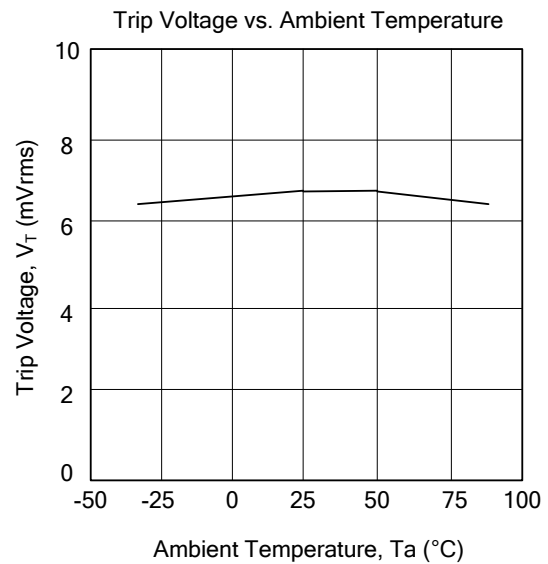
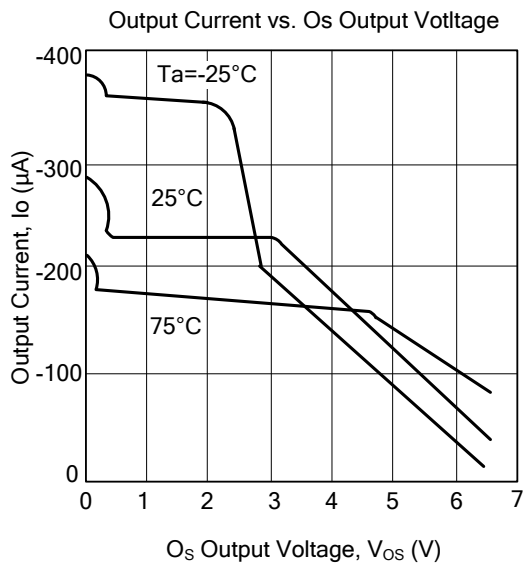
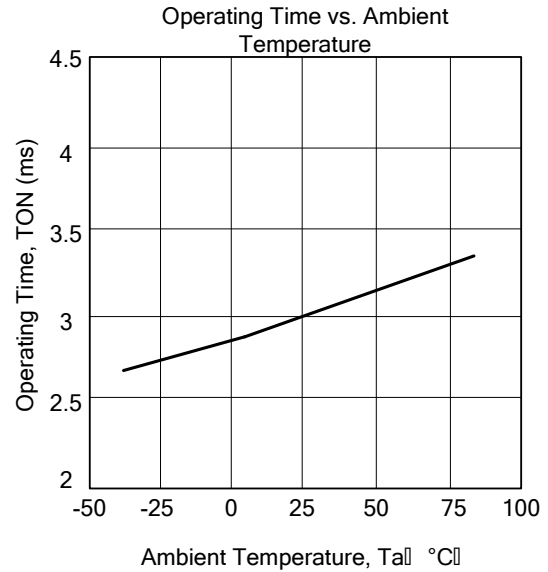
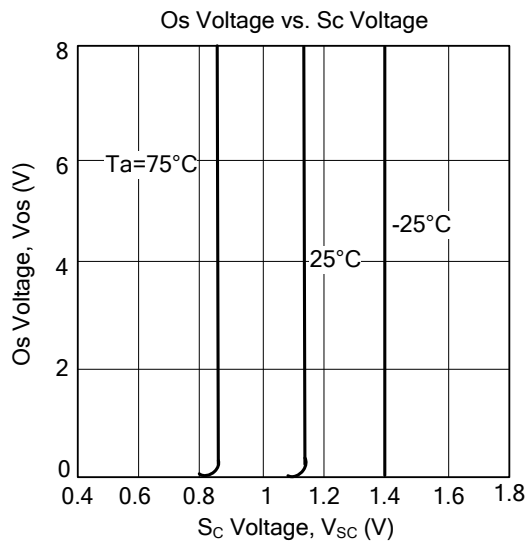

UTC assumes no responsibility for equipment failures that result from using products at values that exceed, even momentarily, rated values (such as maximum ratings, operating condition ranges, or other parameters) listed in products specifications of any and all UTC products described or contained herein. UTC products are not designed for use in life support appliances, devices or systems where malfunction of these products can be reasonably expected to result in personal injury. Reproduction in whole or in part is prohibited without the prior written consent of the copyright owner. The information presented in this document does not form part of any quotation or contract, is believed to be accurate and reliable and may be changed without notice.