

UMW PS2501 PHOTOCOUPLER

Unit in mm

HIGH ISOLATION VOLTAGE
SINGLE TRANSISTOR TYPE
MULTI PHOTOCOUPLER SERIES

DESCRIPTION

The PS2501-1, -2, -4 are optically coupled isolators containing a GaAs light emitting diode and an NPN silicon phototransistor.

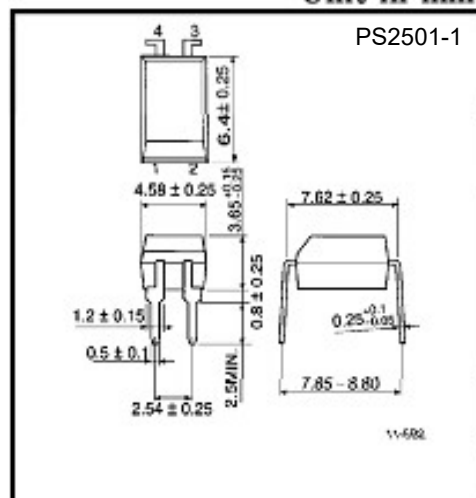

Weight : 0.26 g

FEATURES

- High isolation voltage (BV = 5 000 Vr.m.s.)
- High collector to emitter voltage (V_{CEO} = 80 V)
- High-speed switching (t_r = 3 μs TYP., t_f = 5 μs TYP.)
- UL approved: File No. E492440

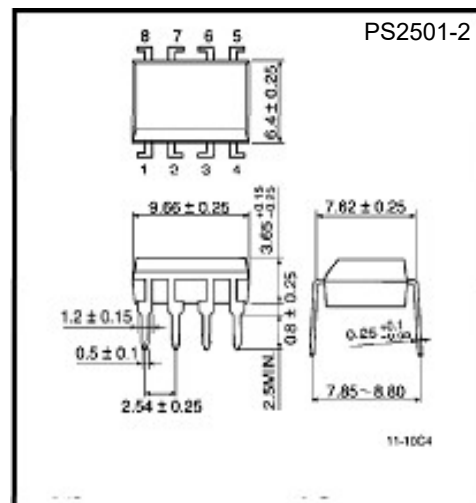

Weight : 0.54 g

Unit: mm

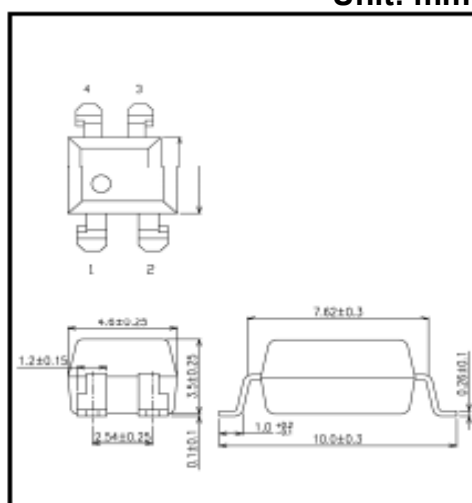

Weight : 1.1 g

Weight: 0.31g (typ.)

ABSOLUTE MAXIMUM RATINGS (T_A = 25 °C, unless otherwise specified)

Parameter		Symbol	Ratings		Unit
			PS2501-1,	PS2501-2,-4	
Diode	Reverse Voltage	V _R	6		V
	Forward Current (DC)	I _F	80		mA
	Power Dissipation Derating	ΔP _D /°C	1.5	1.2	mW/°C
	Power Dissipation	P _D	150	120	mW/ch
	Peak Forward Current ^{*1}	I _{FP}	1		A
Transistor	Collector to Emitter Voltage	V _{CEO}	80		V
	Emitter to Collector Voltage	V _{ECO}	7		V
	Collector Current	I _C	50		mA/ch
	Power Dissipation Derating	ΔP _C /°C	1.5	1.2	mW/°C
	Power Dissipation	P _C	150	120	mW/ch
Isolation Voltage ^{*2}		BV	5 000		Vr.m.s.
Operating Ambient Temperature		T _A	-55 to +100		°C
Storage Temperature		T _{stg}	-55 to +150		°C

*1 PW = 100 μs, Duty Cycle = 1 %

*2 AC voltage for 1 minute at T_A = 25 °C, RH = 60 % between input and output

ELECTRICAL CHARACTERISTICS (T_A = 25 °C)

Parameter		Symbol	Conditions	MIN.	TYP.	MAX.	Unit
Diode	Forward Voltage	V _F	I _F = 10 mA		1.17	1.4	V
	Reverse Current	I _R	V _R = 5 V			5	μA
	Terminal Capacitance	C _t	V = 0 V, f = 1.0 MHz		50		pF
Transistor	Collector to Emitter Dark Current	I _{CEO}	V _{CE} = 80 V, I _F = 0 mA			100	nA
Coupled	Current Transfer Ratio (I _C /I _F) ^{*1}	CTR	I _F = 5 mA, V _{CE} = 5 V	80	300	600	%
	Collector Saturation Voltage	V _{CE(sat)}	I _F = 10 mA, I _C = 2 mA			0.3	V
	Isolation Resistance	R _{I-O}	V _{I-O} = 1.0 kV _{DC}	10 ¹¹			Ω
	Isolation Capacitance	C _{I-O}	V = 0 V, f = 1.0 MHz		0.5		pF
	Rise Time ^{*2}	t _r	V _{CC} = 10 V, I _C = 2 mA, R _L = 100 Ω		3		μs
Fall Time ^{*2}	t _f			5			

*1 C

*2 Test circuit for switching time

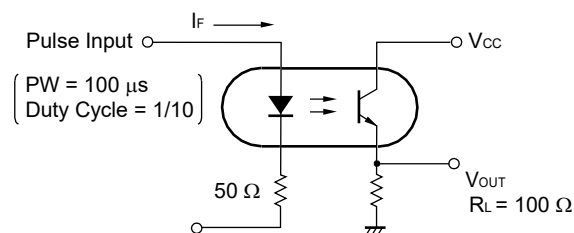

Current Transfer Ratio

Type	Classification (Note 1)	Current Transfer Ratio (%) (I _C / I _F)		Marking of Classification
		I _F = 5mA, V _{CE} = 5V, T _a = 25°C		
		Min	Max	
PS2501	None	80	600	Blank
	Rank Q	100	200	Q
	Rank W	130	260	W
	Rank H	80	160	H
	Rank D	100	300	D
	Rank M	80	240	M
	Rank L	200	400	L
	Rank K	300	600	K
	Rank	—	—	—

★ TYPICAL CHARACTERISTICS ($T_A = 25\text{ }^\circ\text{C}$, unless otherwise specified)

DIODE POWER DISSIPATION vs. AMBIENT TEMPERATURE

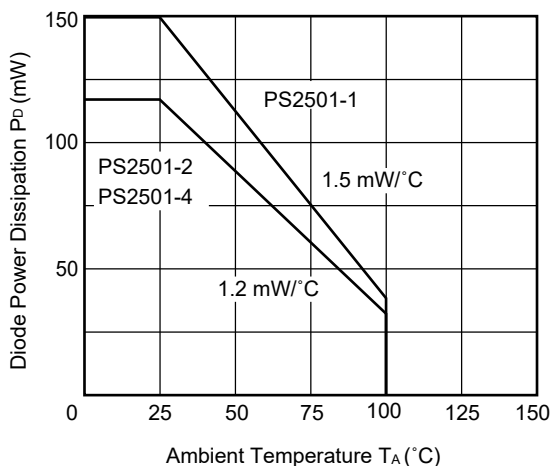

TRANSISTOR POWER DISSIPATION vs. AMBIENT TEMPERATURE

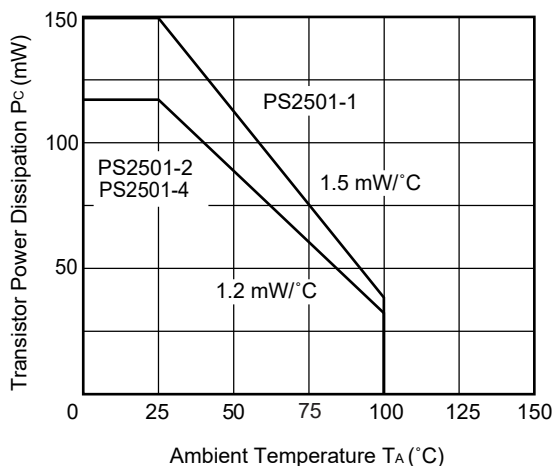

FORWARD CURRENT vs. FORWARD VOLTAGE

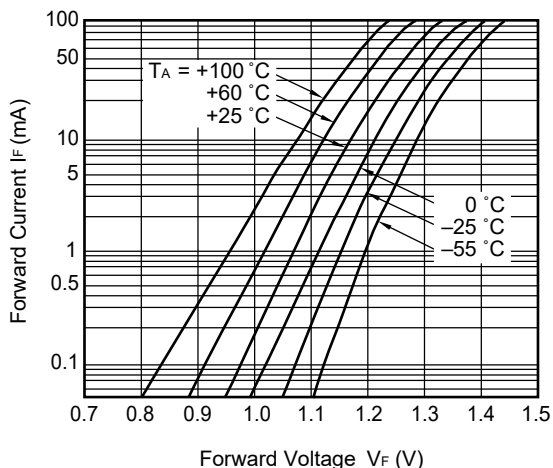

COLLECTOR CURRENT vs. COLLECTOR TO EMITTER VOLTAGE

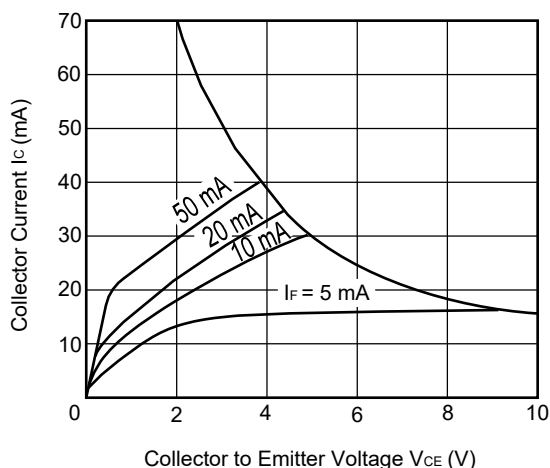

COLLECTOR TO EMITTER DARK CURRENT vs. AMBIENT TEMPERATURE

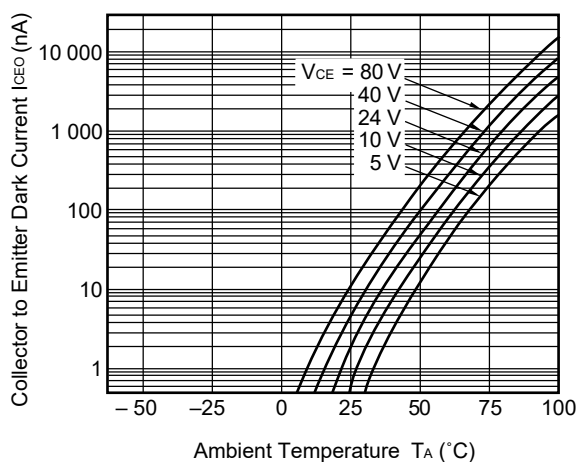

COLLECTOR CURRENT vs. COLLECTOR SATURATION VOLTAGE

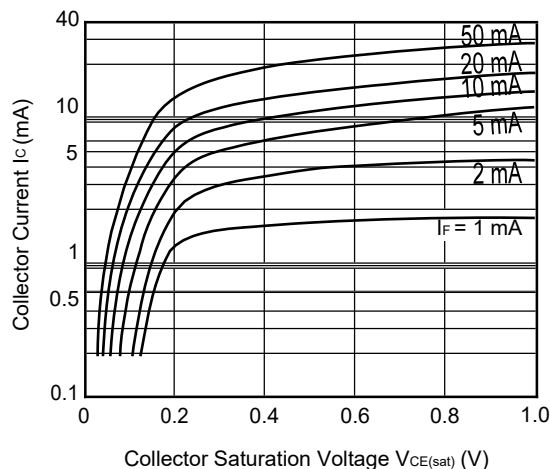

NORMALIZED CURRENT TRANSFER RATIO vs. AMBIENT TEMPERATURE

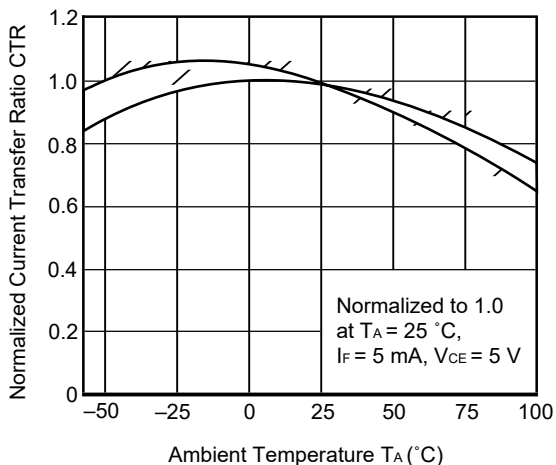

CURRENT TRANSFER RATIO vs. FORWARD CURRENT

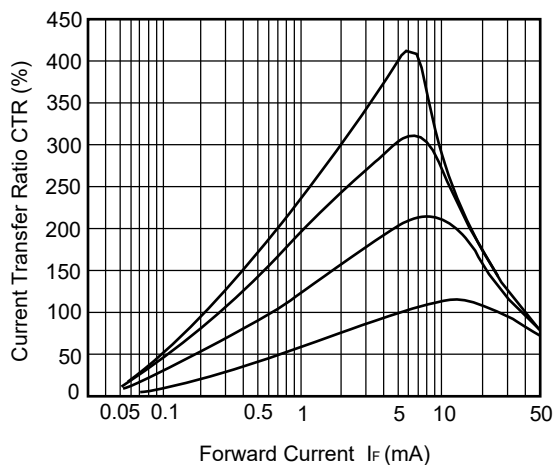

SWITCHING TIME vs. LOAD RESISTANCE

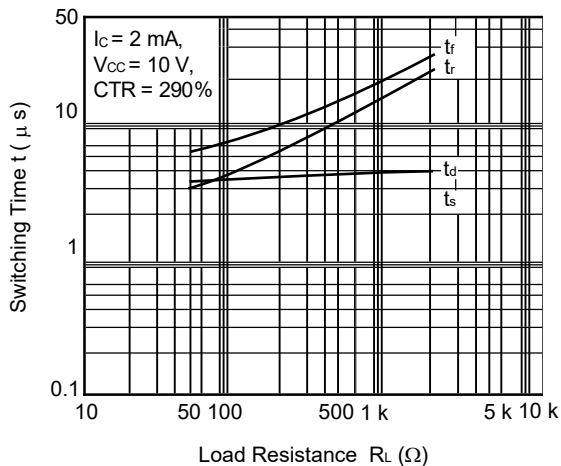

SWITCHING TIME vs. LOAD RESISTANCE

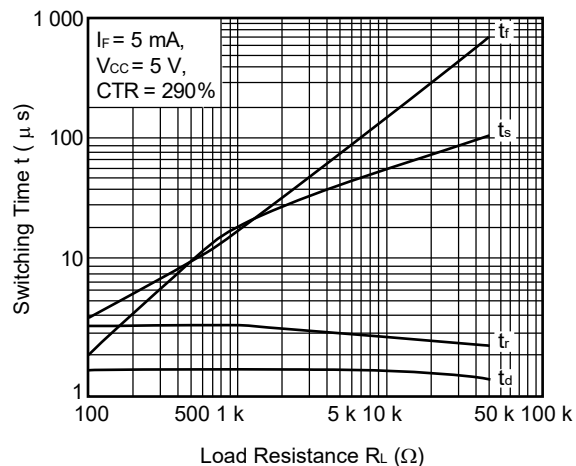

FREQUENCY RESPONSE

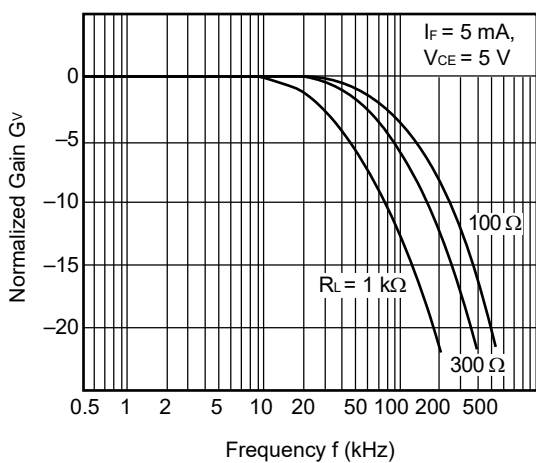

LONG TERM CTR DEGRADATION

