

## MKP 型金属化聚丙烯膜抗干扰电容器

### Metallized Polypropylene Film Capacitor For Electromagnetic Interference Suppression Type MKP (X2 class)

#### ■ 特点 Features

- 体积小、阻燃塑壳封装、阻燃环氧灌注 small size; encapsulated in flame retardant plastic case; Its components are sealed with epoxy resin.
- 能承受过压冲击 Withstand over voltage stressing
- 有自愈性 With Self-healing property
- 用于电源网络连接，抗电磁干扰 Usage of connection to the supply mains, electromagnetic interferences suppression
- 用于电火花抑制电路 Applied to sparkle-suppression circuits
- 用于功率开关电源 Applied to the mains of power switch





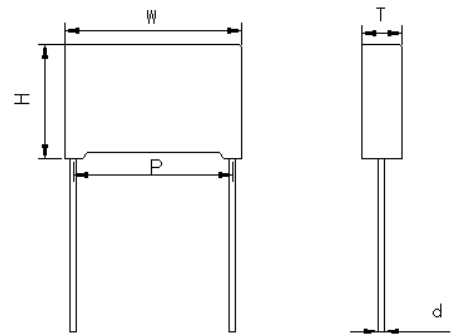

#### ■技术规范 Technical Specifications

- 引用标准 Reference standard GB/T 14472 (IEC 60384-14)
- 额定值和特性 Ratings and Characteristics
- 气候类别 Climate category: 40/100/56
- 额定电压 Rated voltage: 275VAC~305VAC
  
- 电容量范围 Capacitance range:  $0.01 \sim 1.0 \mu\text{F}$
- 电容量偏差 Cap. tolerance:  $\pm 10\%$  (K)、 $\pm 20\%$  (M)
- 损耗角正切 Dissipation factor:  $C < 0.47 \mu\text{F}$ ,  $\text{tg } \delta \leq 12 \times 10^{-4}$  (20°C, 10KHz)  
 $C \geq 0.47 \mu\text{F}$ ,  $\text{tg } \delta \leq 15 \times 10^{-4}$  (20°C, 10KHz)
- 耐电压 voltage proof:  $4.3U_n$  (DC) (2S)
- 绝缘电阻 I. R.: 测试电压为 500V,  $C \leq 0.33 \mu\text{F}$ ,  $R \geq 30000\text{M}\Omega$ ;  $C > 0.33 \mu\text{F}$ ,  $R \geq 10000\text{S}$

#### ■安全认证 safety Approvals

本产品已通过 GB/T 14472 (IEC 60384-14) EN 132400、UL1283 等标准的试验，取得欧洲、美国及国内的认证证书。The product has been tested with the edition standards, Such as GB/T 14472 (IEC 60384-14) EN 132400, UL1283 etc. and acquired correlative safety certificates from Europe, America and the domestic .

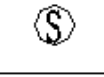

●		VDE	DIN EN 60384-14, 275VAC, 305VAC, 0.01 $\mu$ F ~ 1.0 $\mu$ F Certificate No. :40048412
●		CQC	GB/T 14472, 275VAC, 0.01 $\mu$ F ~ 1.0 $\mu$ F Certificate No. :CQC 03001004439
●		UL/CUL	UL60384, 250VAC, 275VAC, 305VAC, 0.01 $\mu$ F ~ 1.0 $\mu$ F Certificate No. : E214748
●		NEMKO	IEC 60384-14, EN 132400, 275VAC, 0.01 $\mu$ F ~ 1.0 $\mu$ F Certificate No. :P02100305
●		FIMKO	IEC 60384-14, EN, 132400, 275VAC, 0.01 $\mu$ F ~ 1.0 $\mu$ F Certificate No. :221392
●		SEMKO	IEC 60384-14, EN, 132400, 275VAC, 0.01 $\mu$ F ~ 1.0 $\mu$ F Certificate No. :0204005/01
●		DEMKO	IEC 60384-14, EN 132400, 275VAC, 0.01 $\mu$ F ~ 1.0 $\mu$ F Certificate No. :311257-01
●		SWISS	IEC 60384-14, EN 132400, 275VAC, 0.01 $\mu$ F ~ 1.0 $\mu$ F Certificate No. :2.0087

■外形尺寸 Dimensions(mm)

电容量 ( $\mu$ F)	额定电压 (V)	外形尺寸 Dimensions (mm)				
		W $\pm$ 0.5	H $\pm$ 0.5	T $\pm$ 0.5	p $\pm$ 1	d
0.01	275 (305)	13	11	5	10	0.6
0.015		13	11	5	10	0.6
0.022		13	11	5	10	0.6
0.033		13	11	5	10	0.6
0.047		13	11	5	10	0.6
0.068		13	11	5	10	0.6
0.1		13	12	6	10	0.6
0.15		18	11	5	15	0.8
0.22		18	14.5	8.5	15	0.8
0.33		18	14.5	8.5	15	0.8
0.47		18	16	10	15	0.8
0.68		26.5	17	8.5	22.5	0.8
1.0		26.5	19	10	22.5	0.8

注：表中以外的规格和尺寸，可以商谈。

Note: Other specifications and dimensions out of the table are discussible .