

REV	LOCATIONS	DESCRIPTION	DATE	REVISER	APPD

Notes:

1. Material: Phosphor Bronze C5191
2. Plating: Tin-Plated
3. Wire Range: 28AWG~24AWG
4. Insulation Nom. Dia: $\phi 0.37'$ ($\phi 1.70\text{mm Max}$)
5. Applicable Housing: FHG35001Series
6. Minimum Order Quantity : 8,000 PCS

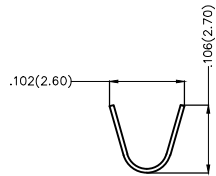
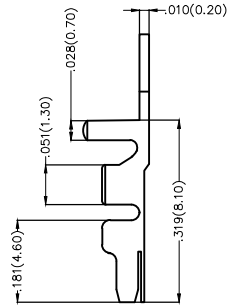
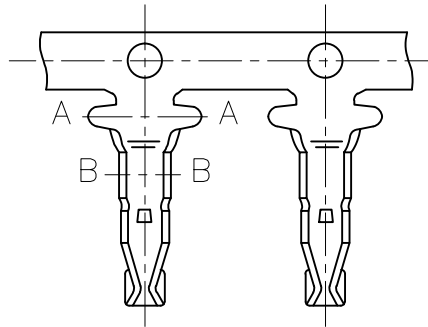

Section A-A

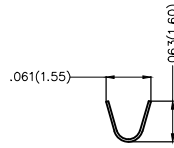

Section B-B

 THIRD ANGLE PROJECTION	GENERAL TOLERANCES (UNLESS SPECIFIED)		APPROVE BY FRANK	DATE 25/JUN/13	PART NO. FT35001-F2H	ITEM NO. FT35001	 Leader Of Industry	
	DESIGN UNITS Inch (metric)	X. \pm .012(0.30) X.X \pm .008(0.20)	X. \pm 5' .X \pm 2'	CHECKED BY JACOB	DATE 25/JUN/13	TITLE Wire to Board Pitch 3.50mm(Terminal)		REV 0
SCALE 5:1	SIZE A4	X.XX \pm .006(0.15) X.XXX \pm .004(0.10)	.XX \pm 1' .XXX \pm 0.5'	DRAWN BY CHERRY	DATE 25/JUN/13	THIS DRAWING CONTAINS INFORMATION THAT IS PROPRIETARY TO TXGA INDUSTRIAL ELECTRONICS(S.Z)CO.,LTD AND SHOULD NOT BE USED WITHOUT WRITTEN PERMISSION		

REV	LOCATIONS	DESCRIPTION	DATE	REVISER	APPD

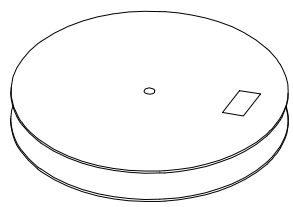
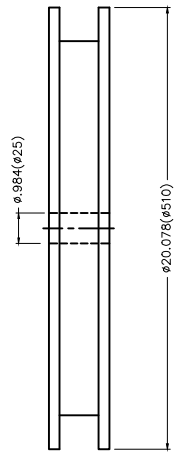
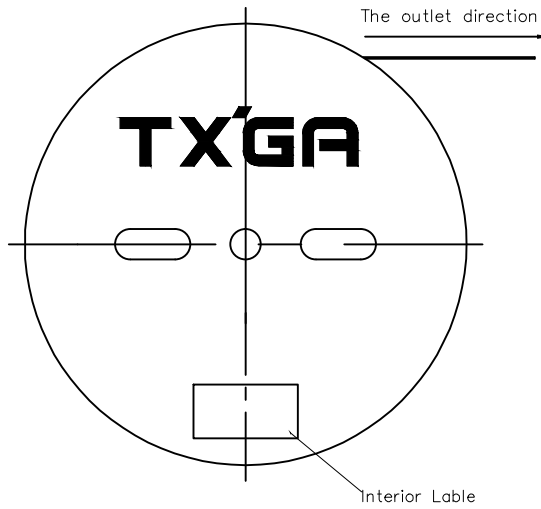

8,000Pcs/Reel

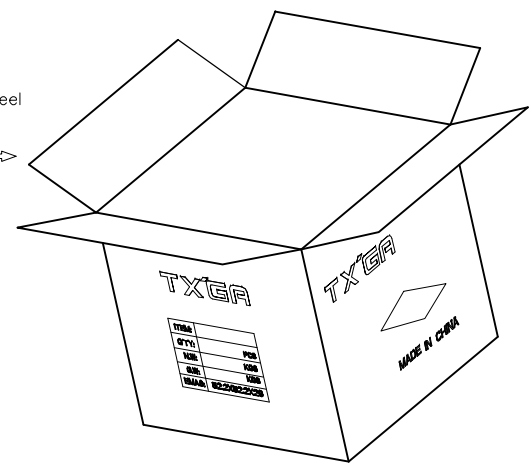

 THIRD ANGLE PROJECTION	GENERAL TOLERANCES (UNLESS SPECIFIED)		APPROVE BY	DATE	PART NO.	ITEM NO.	 Leader Of Industry
	X. \pm .012(0.30)	X. \pm 5'	FRANK	25/JUN/13	FT35001-F2H	FT35001	
	X.X \pm .008(0.20)	.X \pm 2'	CHECKED BY	DATE	TITLE		REV 0 SHEET NO. 2/2
	X.XX \pm .006(0.15)	.XX \pm 1'	JACOB	25/JUN/13	Wire to Board Pitch 3.50mm(Terminal)		
SCALE	SIZE	X.XXX \pm .004(0.10)	.XXX \pm 0.5'	DRAWN BY	DATE	THIS DRAWING CONTAINS INFORMATION THAT IS PROPRIETARY TO TXGA INDUSTRIAL ELECTRONICS(S.Z)CO.,LTD AND SHOULD NOT BE USED WITHOUT WRITTEN PERMISSION	
5:1	A4			CHERRY	25/JUN/13		