

REV	LOCATIONS	DESCRIPTION	DATE	REVISER	APPD

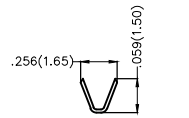

Section A-A

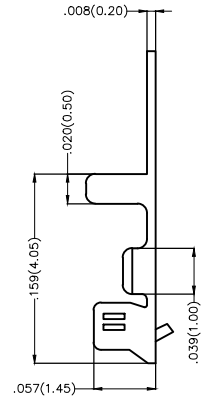
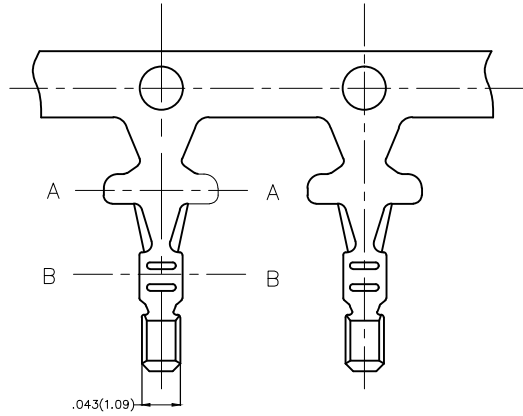
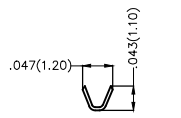

Section B-B

Notes:

1. Material: Phosphor Bronze C5191
2. Plating: Tin-Plated
3. Wire Range: 26AWG~32AWG
4. Insulation Nom. Dia: $\phi 0.35'$ ($\phi 0.9$ mm Max)
5. Applicable Housing: FHG15001Series
6. Minimum Order Quantity : 18,000 PCS

 THIRD ANGLE PROJECTION	GENERAL TOLERANCES (UNLESS SPECIFIED)		APPROVE BY FRANK	DATE 25/JUN/13	PART NO. FT15001-F2H	ITEM NO. FT15001	 Leader Of Industry	
	DESIGN UNITS Inch (metric)	X. \pm .012(0.30)	X. \pm 5'	CHECKED BY JACOB	DATE 25/JUN/13	TITLE Wire to Board Pitch 1.5mm(Terminal)		REV 0
SCALE 5:1	SIZE A4	X.XX \pm .006(0.15)	.XX \pm 1'	DRAWN BY CHERRY	DATE 25/JUN/13	THIS DRAWING CONTAINS INFORMATION THAT IS PROPRIETARY TO TXGA INDUSTRIAL ELECTRONICS(S.Z)CO.,LTD AND SHOULD NOT BE USED WITHOUT WRITTEN PERMISSION		
		X.XXX \pm .004(0.10)	.XXX \pm 0.5'					

REV	LOCATIONS	DESCRIPTION	DATE	REVISER	APPD

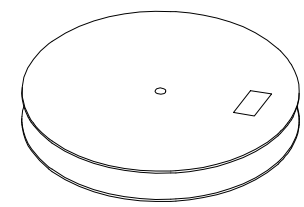
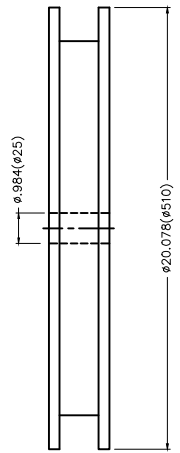
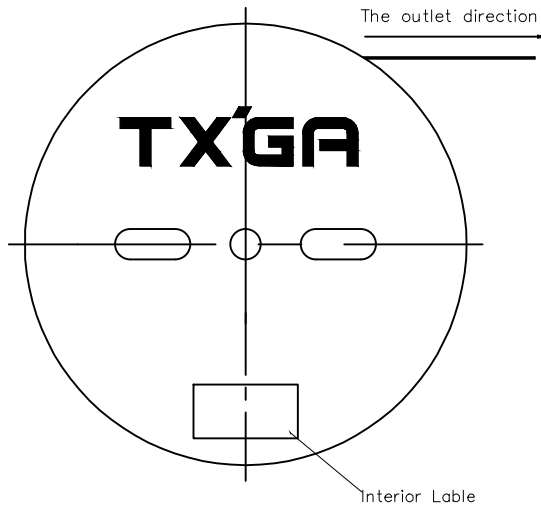

18,000Pcs/Reel

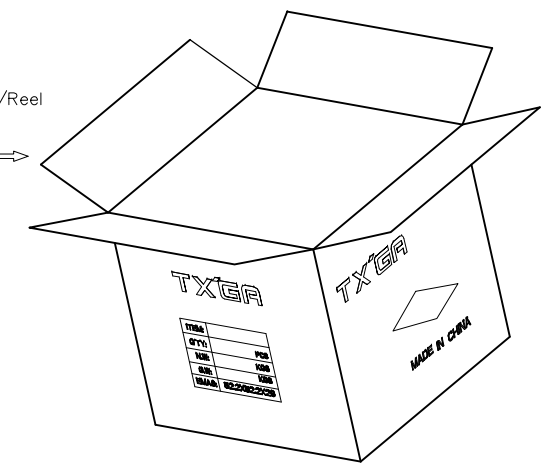

 THIRD ANGLE PROJECTION	GENERAL TOLERANCES (UNLESS SPECIFIED)		APPROVE BY FRANK	DATE 25/JUN/13	PART NO. FT15001-F2H	ITEM NO. FT15001	 Leader Of Industry	
	X.±.012(0.30)	X.±5'	CHECKED BY JACOB	DATE 25/JUN/13	TITLE Wire to Board Pitch 1.5mm(Terminal)			REV 0
	DESIGN UNITS Inch (metric)	X.XX±.008(0.20)	.X'±2'	DRAWN BY CHERRY	DATE 25/JUN/13	THIS DRAWING CONTAINS INFORMATION THAT IS PROPRIETARY TO TXGA INDUSTRIAL ELECTRONICS(S.Z)CO.,LTD AND SHOULD NOT BE USED WITHOUT WRITTEN PERMISSION		
	SCALE 5:1	SIZE A4	X.XX±.006(0.15)	.XX'±1'				
		X.XXX±.004(0.10)	.XXX'±0.5'					