

REV	LOCATIONS	DESCRIPTION	DATE	REVISER	APPD

Electrical
Material: Phosphor Bronze
Plating: Gold-Plated
Wire Range: 28AWG~30AWG
Applicable Housing: FHG12504Series

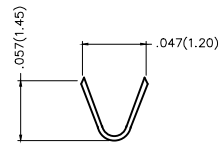

Section A-A

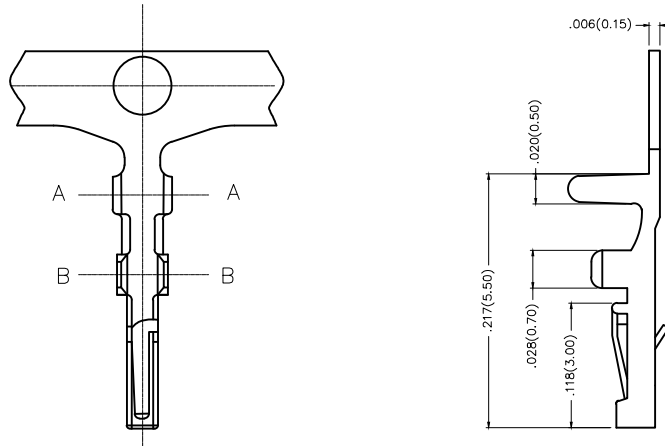
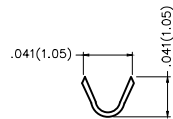

Section B-B

 THIRD ANGLE PROJECTION	GENERAL TOLERANCES (UNLESS SPECIFIED)		APPROVE BY FRANK	DATE 25/JUN/13	PART NO. FT12503-F2H	ITEM NO. FT12503	 Leader Of Industry	
	DESIGN UNITS Inch (metric)	X.±.012(0.30) X.X±.008(0.20)	X.±5° .X±2°	CHECKED BY JACOB	DATE 25/JUN/13	TITLE Wire to Board Pitch 1.25mm(Terminal)		REV 0
SCALE 5:1	SIZE A4	X.XX±.006(0.15) X.XXX±.004(0.10)	.XX±1° .XXX±0.5°	DRAWN BY CHERRY	DATE 25/JUN/13	THIS DRAWING CONTAINS INFORMATION THAT IS PROPRIETARY TO TXGA INDUSTRIAL ELECTRONICS(S.Z)CO.,LTD AND SHOULD NOT BE USED WITHOUT WRITTEN PERMISSION		

REV	LOCATIONS	DESCRIPTION	DATE	REVISER	APPD

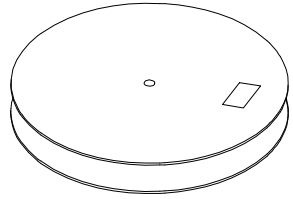
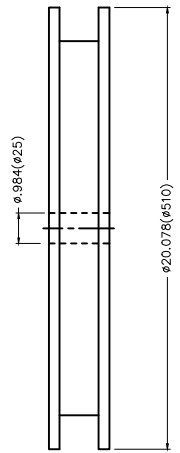
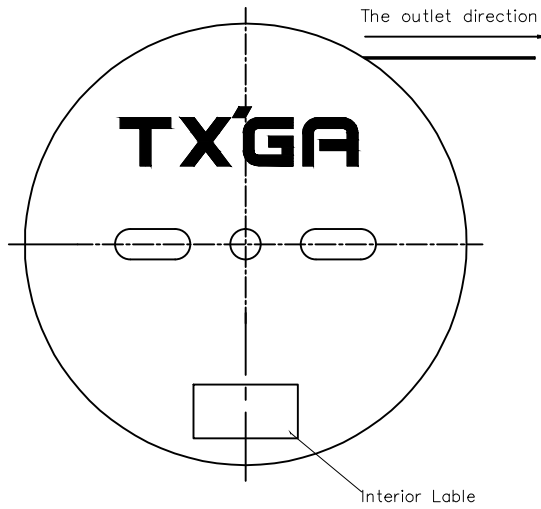

10,000Pcs/Reel

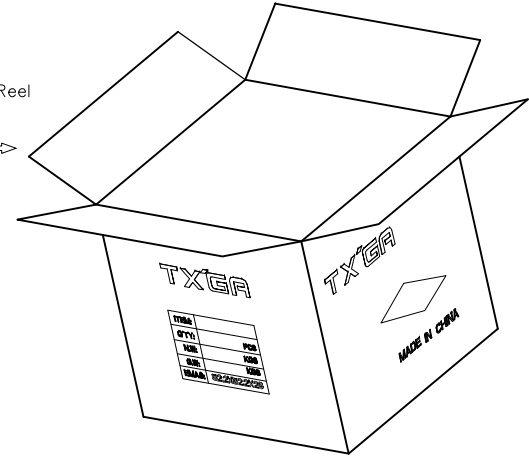

<p>THIRD ANGLE PROJECTION</p>	GENERAL TOLERANCES (UNLESS SPECIFIED)		APPROVE BY	DATE	PART NO.	ITEM NO.	<p>Leader Of Industry</p>
	X.±.012(0.30)	X.±5'	FRANK	25/JUN/13	FT12503-F2H	FT12503	
	X.X±.008(0.20)	.X'±2'	CHECKED BY	DATE	TITLE		REV 0 SHEET NO. 2/2
	X.XX±.006(0.15)	.XX'±1'	JACOB	25/JUN/13	Wire to Board Pitch 1.25mm(Terminal)		
SCALE	SIZE	X.XXX±.004(0.10)	.XXX'±0.5'	DRAWN BY	DATE	THIS DRAWING CONTAINS INFORMATION THAT IS PROPRIETARY TO TXGA INDUSTRIAL ELECTRONICS(S.Z)CO.,LTD AND SHOULD NOT BE USED WITHOUT WRITTEN PERMISSION	
5:1	A4			CHERRY	25/JUN/13		