

REV	LOCATIONS	DESCRIPTION	DATE	REVISER	APPD
1	△	Structure optimization	17/AUG/18	KATE	ANDY

SPECIFICATIONS

Electrical
 Current Rating: 0.5A AC(rms)/DC
 Voltage Rating: 50V AC(rms)/DC
 Contact Resistance: 30 mΩ Max
 Insulation Resistance: 500 MΩ MIN
 Withstanding Voltage: 200V AC r.m.s
 Temperature Range-Operating: -25°C~+85°C
 Material And Plating
 Housing: Thermoplastic UL94V-0/ Natural
 Actuator: Thermoplastic UL94V-0/ Black
 Terminal: Copper Alloy /Gold plated
 LEG: Copper Alloy /Tin plated

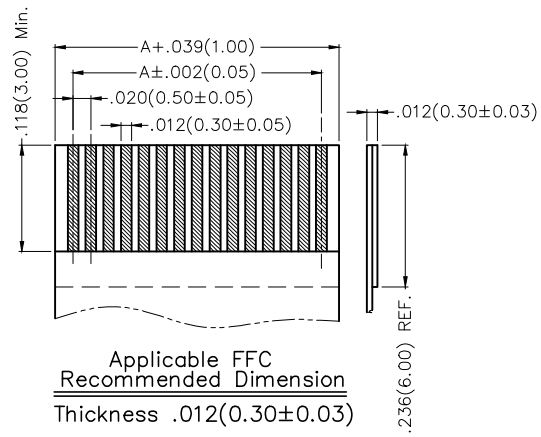
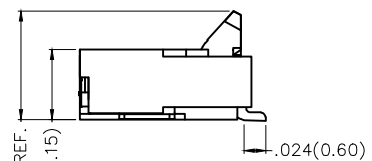
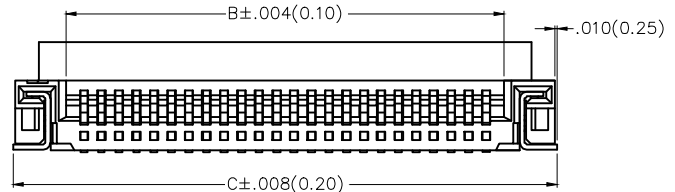
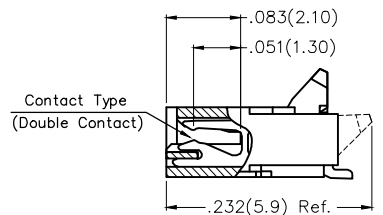
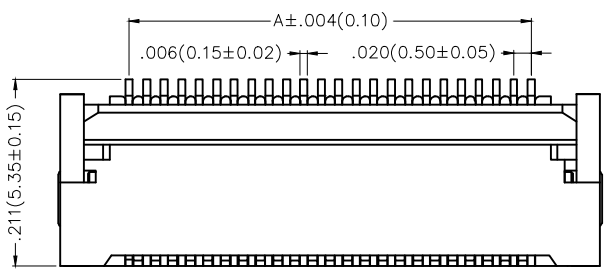

Applicable FFC
 Recommended Dimension
 Thickness .012(0.30±0.03)

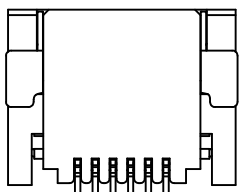
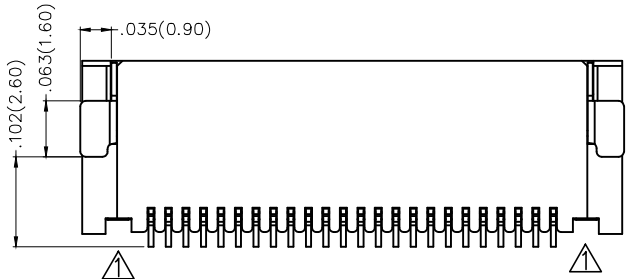

No.4~14 Circuits

Ordering Information

FFC	050	36	—	XX	S	B	D	1	1	3	W5	M
1	2	3		4	5	6	7	8	9	10	11	12

1 Category FFC-FPC	2 Series Number 050-Pitch0.50mm	3 Distinction No. 36	4 Circuits XX	5 Assemble Layout S-SMT	6 Entry Angle B- 90° Angle
7 Contact Type D-Double Contact	8 ZIF 1-ZIF	9 Plating 1-Gold plated	10 Material-Resin 3-LCP	11 Color-Resin W5-Housing: Natural, Actuator: Black	12 Packaging M-Reel

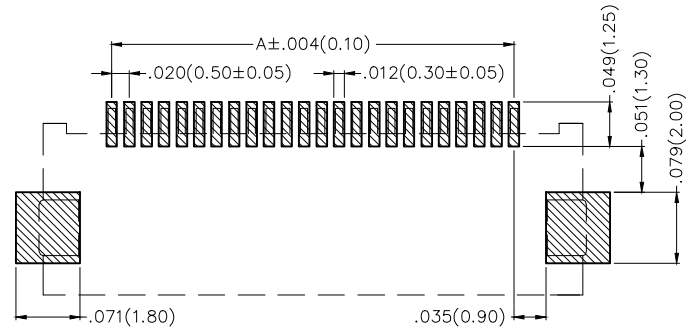

Recommended P.C.Board Layout
 General tolerances: ±.020(0.05)

THIRD ANGLE PROJECTION	GENERAL TOLERANCES (UNLESS SPECIFIED)		APPROVE BY FRANK	DATE 18/JUN/13	PART NO. FFC05036-XXSBD113W5M	ITEM NO. FFC05036	 Leader Of Industry
	X.±.012(0.30)	X.±5°	CHECKED BY CHERRY	DATE 18/JUN/13	TITLE FPC/FFC connector 0.5mm Double contact SMT		
DESIGN UNITS Inch (metric)	X.X±.008(0.20)	X.±2°	DRAWN BY KATE	DATE 18/JUN/13	THIS DRAWING CONTAINS INFORMATION THAT IS PROPRIETARY TO TXGA INDUSTRIAL ELECTRONICS(S.Z)CO.,LTD AND SHOULD NOT BE USED WITHOUT WRITTEN PERMISSION		REV 1
SCALE 5:1	SIZE A4	X.XX±.006(0.15)					SHEET NO. 1/3
		X.XXX±.004(0.10)					

1 2 3 4 5 6 7 8

REV	LOCATIONS	DESCRIPTION	DATE	REVISER	APPD

A

A

B

B

C

C

D

D



E

E

F

F

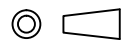
Circuits (n)	Part No.	Dimensions(in/mm)		
		A	B	C
4	FFC05036-04SBD113W5M	.059(1.50)	.102(2.60)	.217(5.50)
6	FFC05036-06SBD113W5M	.098(2.50)	.142(3.60)	.256(6.50)
8	FFC05036-08SBD113W5M	.138(3.50)	.181(4.60)	.295(7.50)
10	FFC05036-10SBD113W5M	.177(4.50)	.220(5.60)	.335(8.50)
12	FFC05036-12SBD113W5M	.217(5.50)	.260(6.60)	.374(9.50)
14	FFC05036-14SBD113W5M	.256(6.50)	.299(7.60)	.413(10.50)
16	FFC05036-16SBD113W5M	.295(7.50)	.339(8.60)	.453(11.50)
18	FFC05036-18SBD113W5M	.335(8.50)	.378(9.60)	.492(12.50)
20	FFC05036-20SBD113W5M	.374(9.50)	.417(10.60)	.531(13.50)
24	FFC05036-24SBD113W5M	.453(11.50)	.496(12.60)	.610(15.50)
26	FFC05036-26SBD113W5M	.492(12.50)	.535(13.60)	.650(16.50)
28	FFC05036-28SBD113W5M	.531(13.50)	.575(14.60)	.689(17.50)
30	FFC05036-30SBD113W5M	.571(14.50)	.614(15.60)	.728(18.50)
36	FFC05036-36SBD113W5M	.689(17.50)	.732(18.60)	.846(21.50)
40	FFC05036-40SBD113W5M	.768(19.50)	.811(20.60)	.925(23.50)
45	FFC05036-45SBD113W5M	.866(22.00)	.909(23.10)	1.024(26.00)
50	FFC05036-50SBD113W5M	.965(24.50)	1.008(25.60)	1.122(28.50)
54	FFC05036-54SBD113W5M	1.043(26.50)	1.087(27.60)	1.201(30.50)
60	FFC05036-60SBD113W5M	1.161(29.50)	1.205(30.60)	1.319(33.50)

 THIRD ANGLE PROJECTION	GENERAL TOLERANCES (UNLESS SPECIFIED)		APPROVE BY FRANK	DATE 18/JUN/13	PART NO. FFC05036-XXSBD113W5M	ITEM NO. FFC05036	 Leader Of Industry	
	X.±.012(0.30)	X.±5'	CHECKED BY CHERRY	DATE 18/JUN/13	TITLE FPC/FFC connector 0.5mm Double contact SMT			REV 1
	DESIGN UNITS Inch (metric)	X.X±.008(0.20)	.X±2'	DRAWN BY KATE	DATE 18/JUN/13	THIS DRAWING CONTAINS INFORMATION THAT IS PROPRIETARY TO TXGA INDUSTRIAL ELECTRONICS(S.Z)CO.,LTD AND SHOULD NOT BE USED WITHOUT WRITTEN PERMISSION		
	SCALE 5:1	SIZE A4	X.XXX±.004(0.10)	.XX±1'	.XXX±0.5'			

1 2 3 4 5 6 7 8

REV	LOCATIONS	DESCRIPTION	DATE	REVISER	APPD

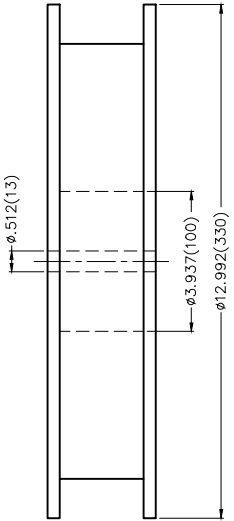
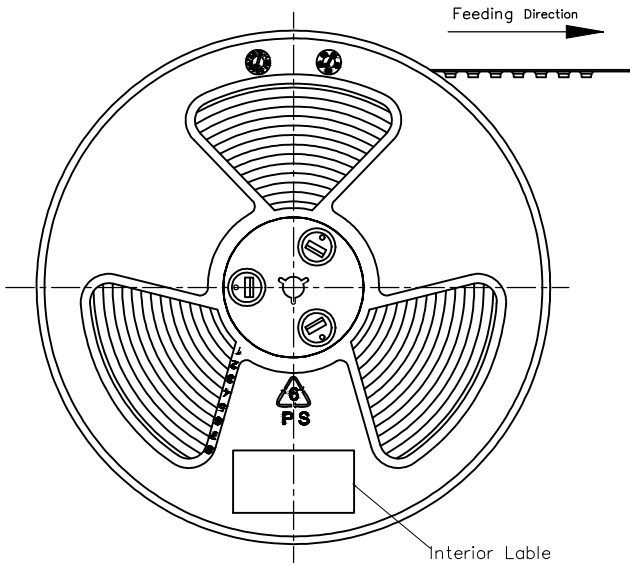

Note:

1. 10 sprocket hole cumulative tolerance ± 0.2
2. Carrier camber is within 1.0mm in 250mm
3. Material: White Conductive polystyrene Alloy 100% recyclable
4. All dimensions meet EIA-481-3 requirements
5. Peel off force of cover tape & carrier tape: 20g~130g(0.2N~1.3N)
6. Component load per 13" reel: 1,500 pcs

Circuits (n)	Dimensions(in/mm)		
	A	B	C
4~20	.945(24.0)	.453(11.5)	—
24~30	1.260(32.0)	.561(14.25)	1.033(28.50)
36~50	1.732(44.0)	.797(20.25)	1.594(40.50)
54~60	2.205(56.0)	1.033(26.25)	2.067(52.50)

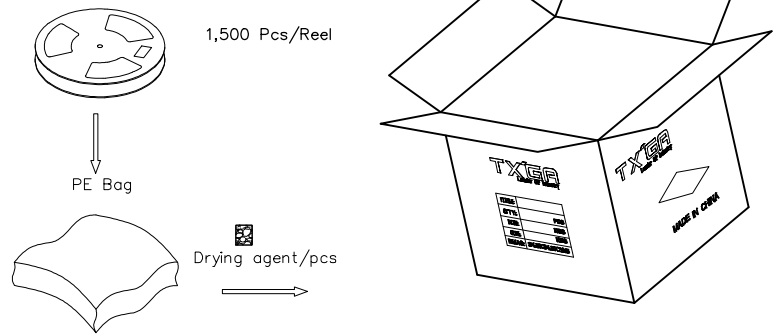
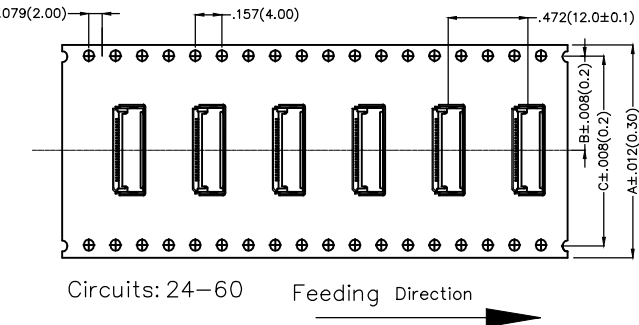
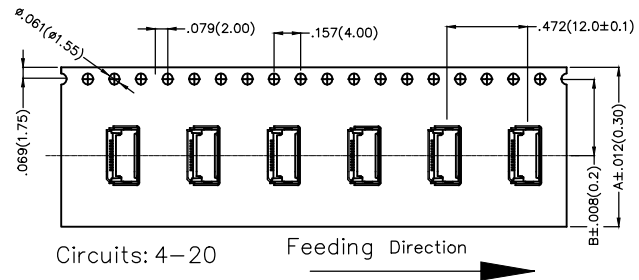
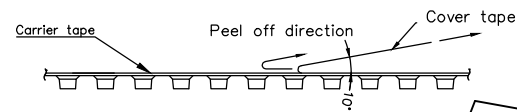
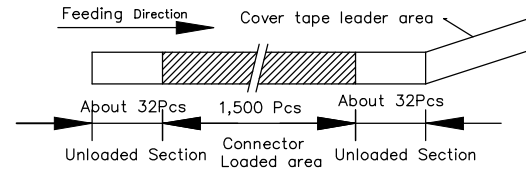

 THIRD ANGLE PROJECTION	GENERAL TOLERANCES (UNLESS SPECIFIED)		APPROVE BY	DATE	PART NO.	ITEM NO.	 Leader Of Industry	
	X.±.012(0.30)	X.±5'	FRANK	18/JUN/13	FFC05036-XXSBD113W5M	FFC05036		
	DESIGN UNITS Inch (metric)	X.X±.008(0.20)	.X'±2'	CHECKED BY	DATE	TITLE		REV 1 SHEET NO. 3/3
	SCALE	X.XX±.006(0.15)	.XX'±1'	JACOB	18/JUN/13	FPC/FFC connector 0.5mm Double contact SMT		
SIZE	X.XXX±.004(0.10)	.XXX'±0.5'	DRAWN BY	DATE	THIS DRAWING CONTAINS INFORMATION THAT IS PROPRIETARY TO TXGA INDUSTRIAL ELECTRONICS(S.Z)CO.,LTD AND SHOULD NOT BE USED WITHOUT WRITTEN PERMISSION			
5:1	A4		KATE	18/JUN/13				