



TAI-SAW TECHNOLOGY CO., LTD.

No. 3, Industrial 2nd Rd., Ping-Chen Industrial District,
Taoyuan, 324, Taiwan, R.O.C.

TEL: 886-3-4690038 FAX: 886-3-4697532

E-mail: tstsales@mail.taisaw.com Web: www.taisaw.com

Product Specifications Approval Sheet

Product Description: SAW Rx Filter 1960MHz LTE Band 2 SMD 1109

TST Part No.: TA1950D

Customer Part No.: _____

Customer signature required
Company: _____
Division: _____
Approved by : _____
Date: _____

Checked by: _____ Jun-Mao Chang 

Approved by: _____ Andy Yu 

Date: _____ 2017, 04. 05

1. Customer signed back is required before TST can proceed with sample build and receive orders.
2. Orders received without customer signed back will be regarded as agreement on the specifications.
3. Any specifications changes must be approved upon by both parties and a new revision of specifications shall be released to reflect the changes.



TAI-SAW TECHNOLOGY CO., LTD.

No. 3, Industrial 2nd Rd., Ping-Chen Industrial District,
 Taoyuan, 324, Taiwan, R.O.C.
 TEL: 886-3-4690038 FAX: 886-3-4697532
 E-mail: tstsales@mail.taisaw.com Web: www.taisaw.com

SAW Rx Filter 1960MHz LTE Band 2 SMD 1109 (60MHz BW)

MODEL NO.: TA1950D

REV. NO.:2

A. MAXIMUM RATING:

1. Input Power Level: 10 dBm
2. DC voltage: 0 V
3. Operating Temperature: -20°C to +85°C
4. Storage Temperature: -40°C to +85°C
5. Moisture Sensitivity Level: Level 3 (MSL 3)
6. ESD 50V(MM) 100V(HBM)

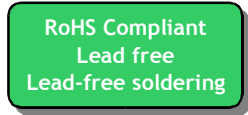

Electrostatic Sensitive Device (ESD)

B. ELECTRICAL CHARACTERISTICS(25°C):

Parameters Description	Unit	Min.	Typ.	Max.
Center Frequency (Fo)	MHz	-	1960	-
Insertion Loss within 1930 ~ 1990 MHz	dB	-	2.8	4
1930.6 ~ 1989.4 MHz	dB	-	2.8	3.7
Amplitude Ripple within 1930 ~ 1990 MHz	dBp-p	-	1.1	2.6
1930.6 ~ 1989.4 MHz	dBp-p	-	1.1	2.3
Input VSWR within 1930~1990 MHz	-	-	2	2.2
Output VSWR within 1930~1990 MHz	-	-	2	2.3
Amplitude balance within 1930.0 ~ 1990.0 MHz	dB	-1.8	-0.9/+1	+1.8
Phase balance within 1930.0 ~ 1990.0 MHz	deg.	-15	-4.6/+8.5	+15
Attenuation:				
10 ~ 1850 MHz	dB	40	54	-
824 ~ 849 MHz	dB	50	62	-
1850 ~ 1910 MHz	dB	35	46	-
2020 ~ 2070 MHz	dB	15	22	-
2070 ~ 6000 MHz	dB	25	32	-

※With Matching Network.

C. MEASUREMENT CIRCUIT:

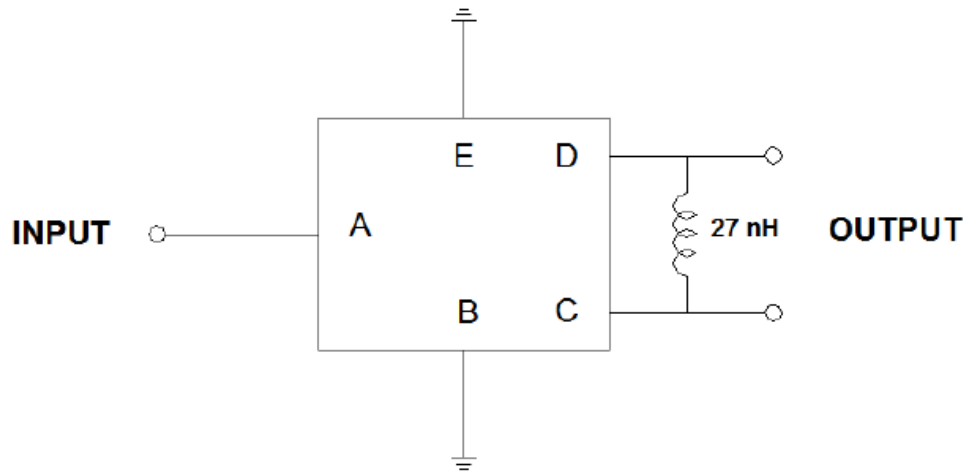

Source Impedance: 50 Ω
Load Impedance : 100 Ω

Pin Description

B, E	Ground
A	Input
D, C	Balance Output

D. OUTLINE DRAWING:

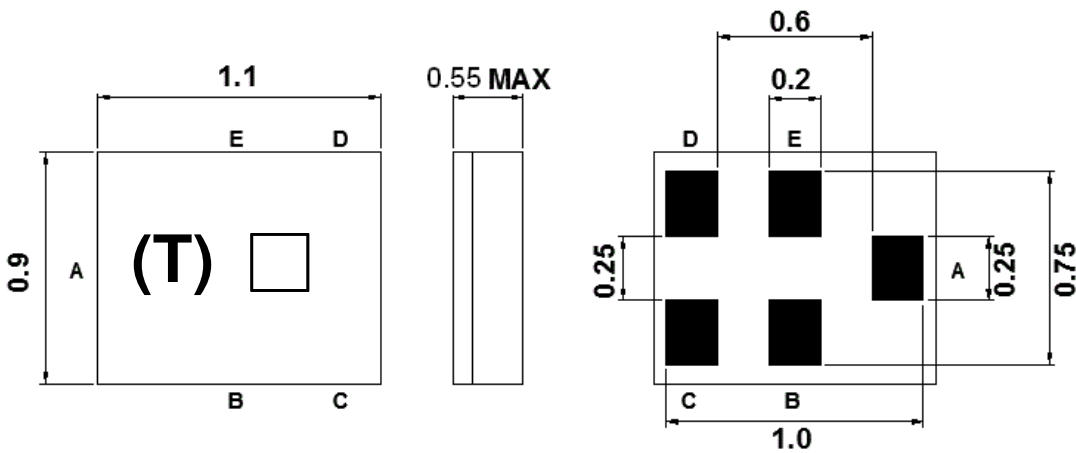

(T): Series Number

□: Date Code(Year+Month)

Date Code Table:

	Jan.	Feb.	Mar.	Apr.	May	Jun.	July	Aug.	Sep.	Oct.	Nov.	Dec.
2015	a	b	c	d	e	f	g	h	j	k	l	m
2016	n	p	q	r	s	t	u	v	w	x	y	z
2017	<u>A</u>	<u>B</u>	<u>C</u>	<u>D</u>	<u>E</u>	<u>F</u>	<u>G</u>	<u>H</u>	<u>J</u>	<u>K</u>	<u>L</u>	<u>M</u>
2018	<u>N</u>	<u>P</u>	<u>Q</u>	<u>R</u>	<u>S</u>	<u>T</u>	<u>U</u>	<u>V</u>	<u>W</u>	<u>X</u>	<u>Y</u>	<u>Z</u>

E. PCB Footprint:

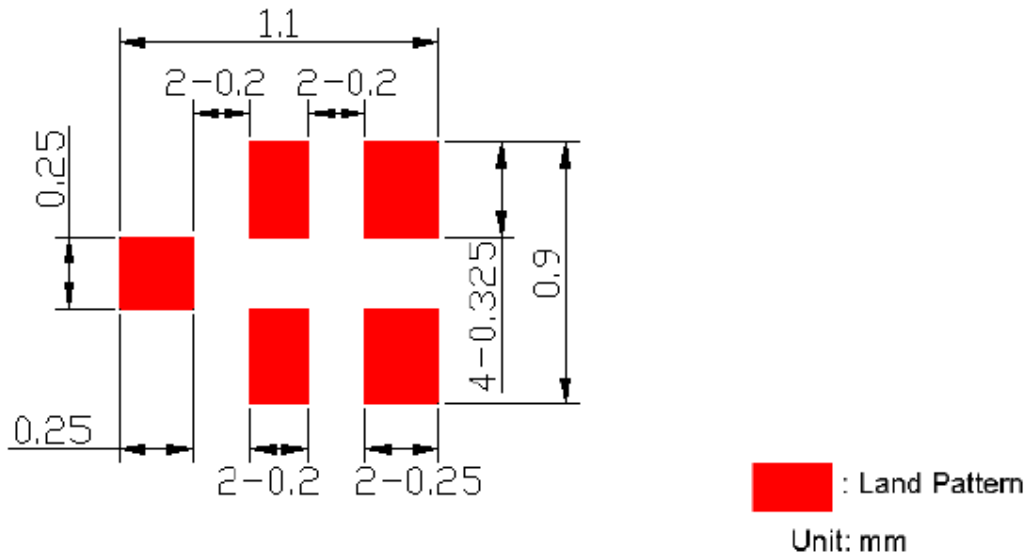

F. Frequency Characteristics:

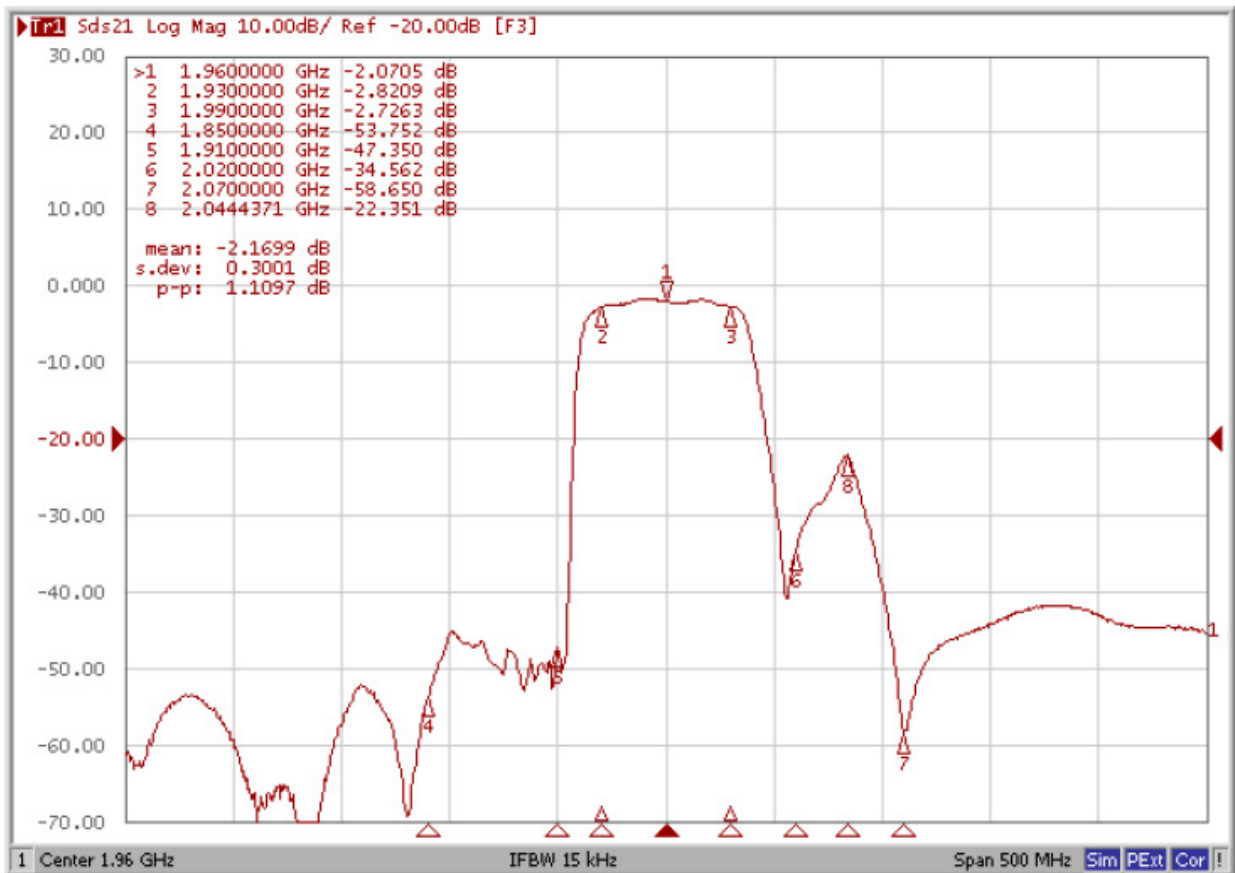

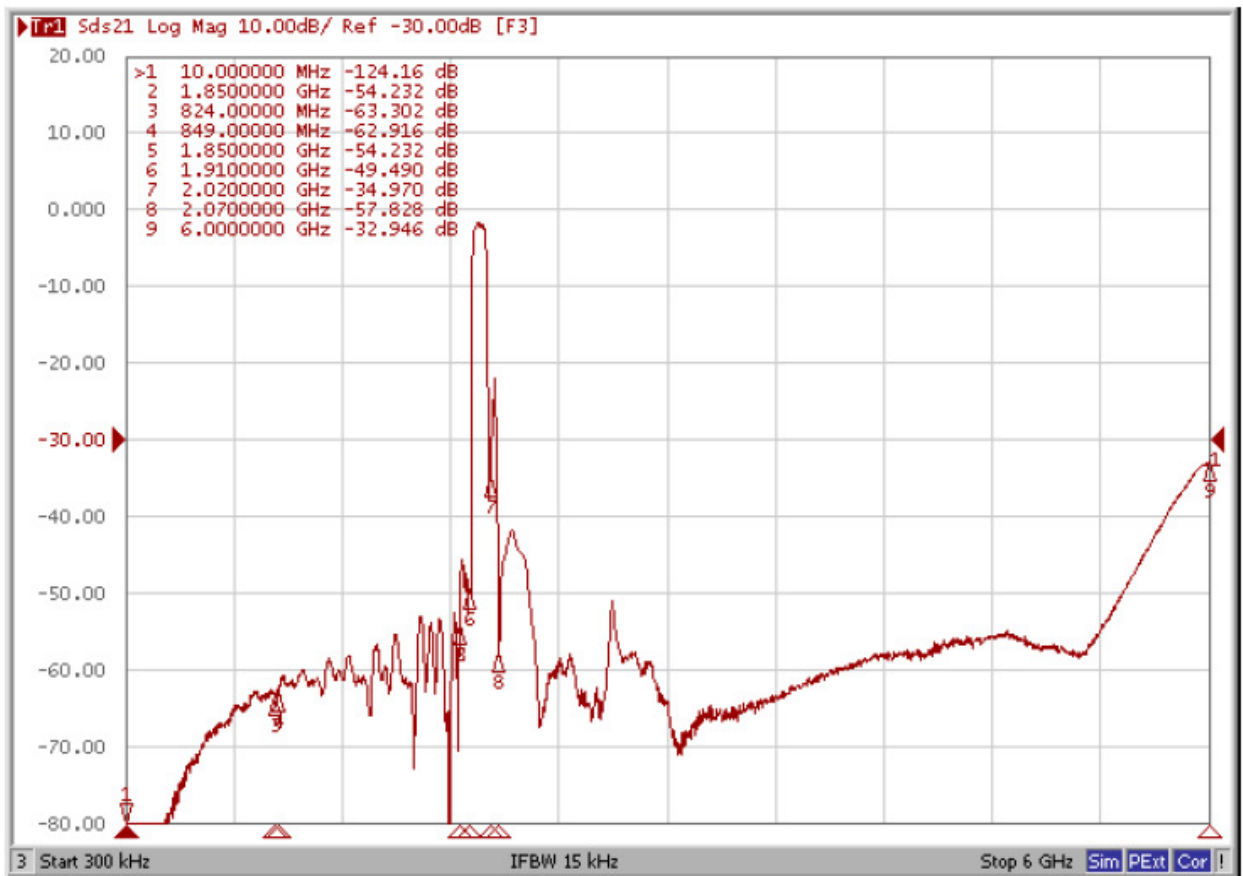

S11 SWR

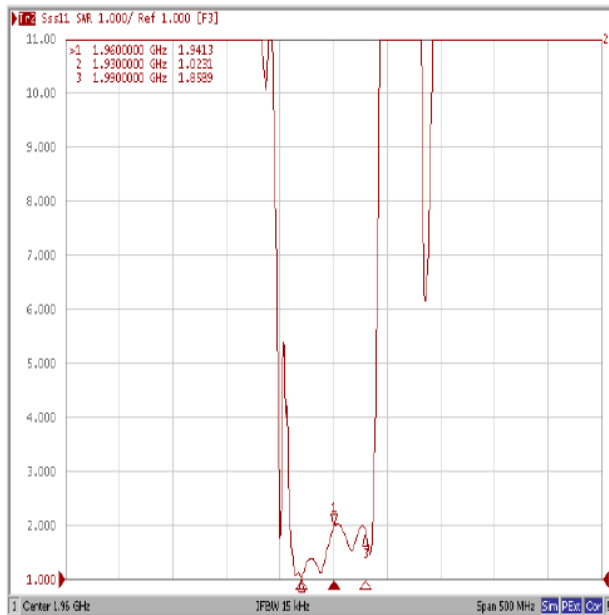

S22 SWR



Smith chart S11

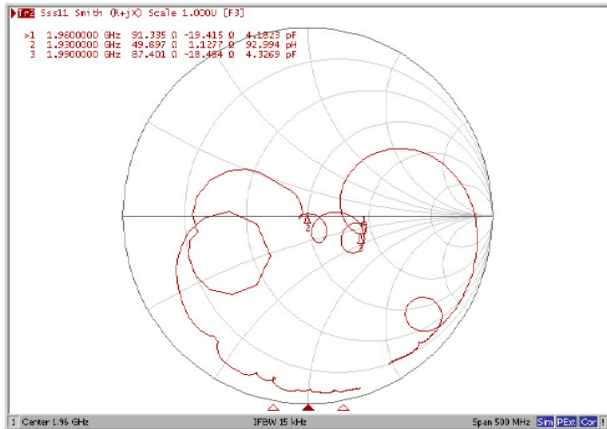

S22

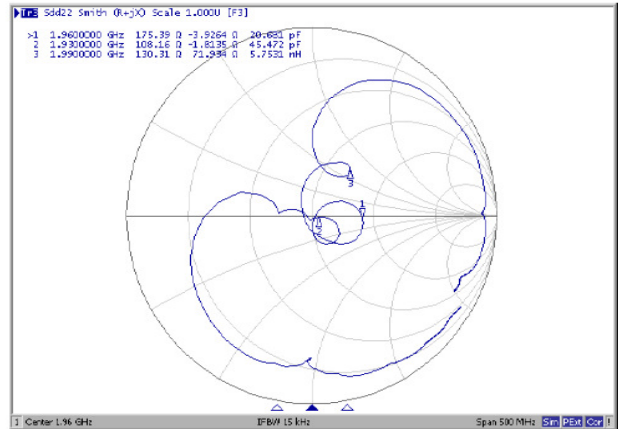

Amplitude balance

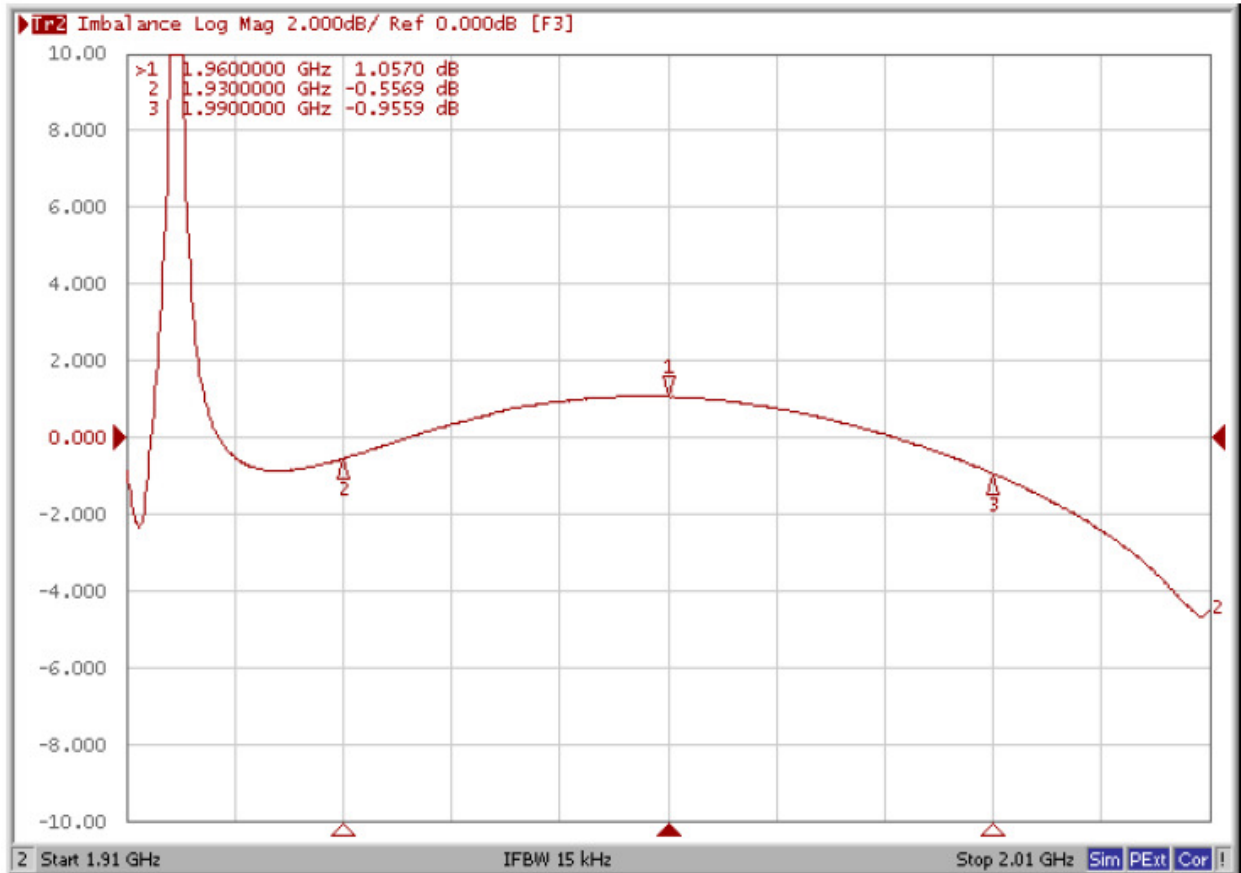

Phase balance

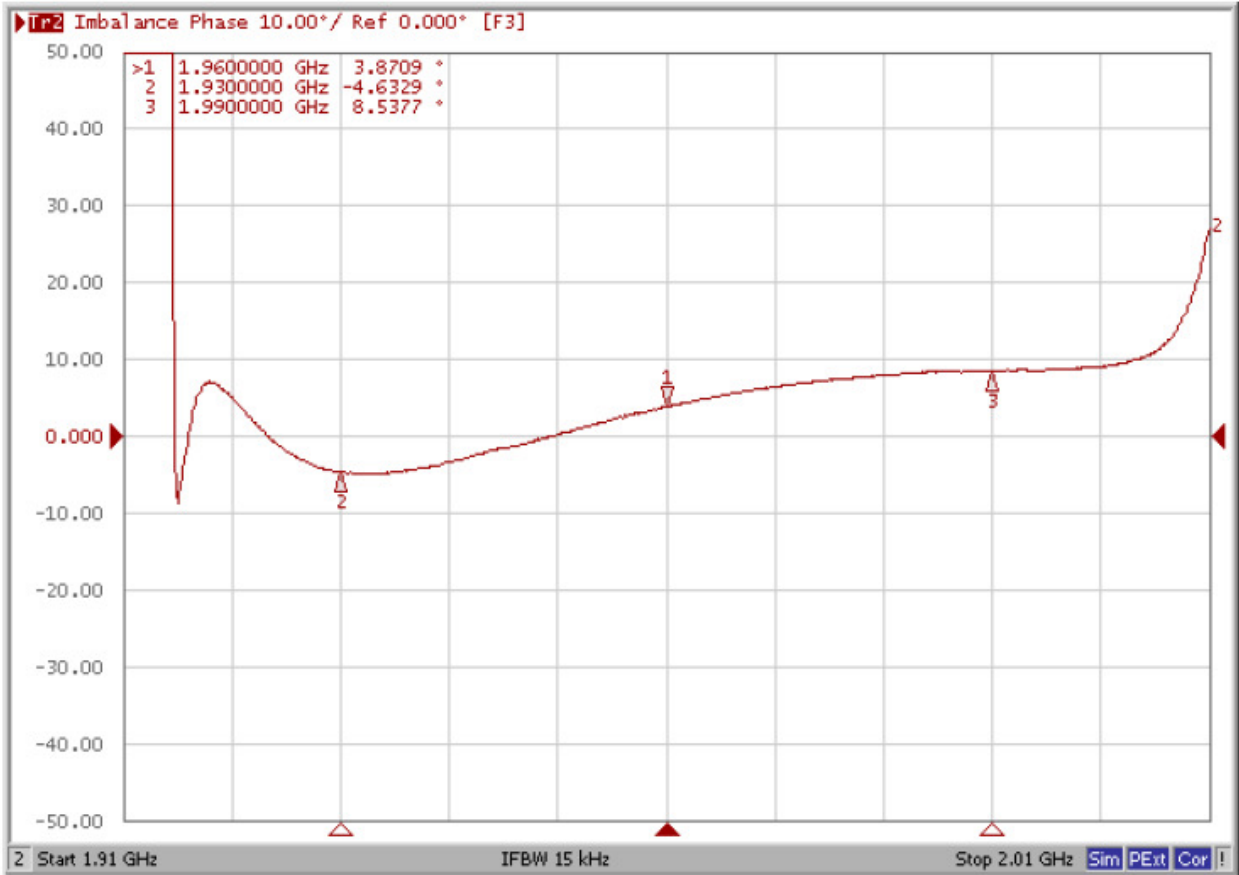

G. PACKING:

1. REEL DIMENSION

7" / 5000pcs

