

TOSHIBA Zener Diode Silicon Epitaxial Type

CRY62 to CRZ39

○ Surge absorber

Unit: mm

- Average power dissipation : $P = 0.7 \text{ W}$
- Zener voltage : $V_Z = 6.2 \text{ to } 39 \text{ V}$
- Suitable for compact assembly due to small surface-mount package "S-FLAT™" (Toshiba package name)

Absolute Maximum Ratings ($T_a = 25^\circ\text{C}$)

Characteristic	Symbol	Rating	Unit
Power dissipation	P	0.7	W
Junction temperature	T_j	-40 to 150	°C
Storage temperature range	T_{stg}	-40 to 150	°C

Note: Using continuously under heavy loads (e.g. the application of high temperature/current/voltage and the significant change in temperature, etc.) may cause this product to decrease in the reliability significantly even if the operating conditions (i.e. operating temperature/current/voltage, etc.) are within the absolute maximum ratings.

Please design the appropriate reliability upon reviewing the Toshiba Semiconductor Reliability Handbook ("Handling Precautions"/"Derating Concept and Methods") and individual reliability data (i.e. reliability test report and estimated failure rate, etc).

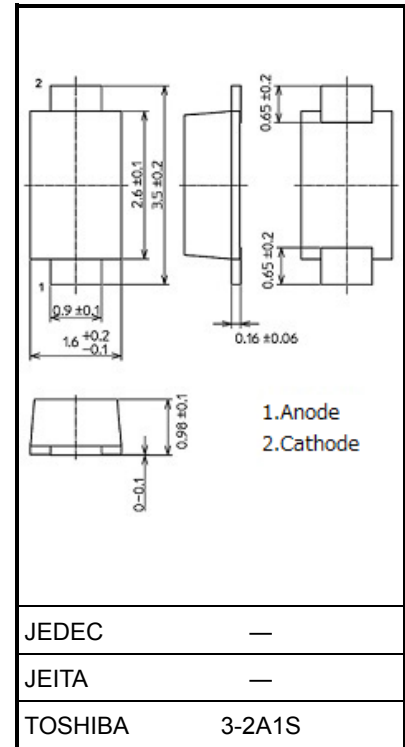

Weight: 0.013 g (typ.)

Land Pattern Dimensions (reference only)

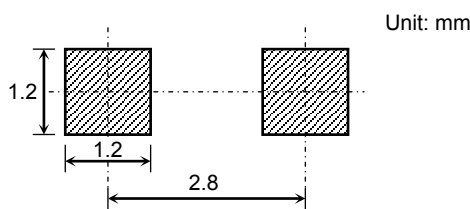

Start of commercial production
1999-09

Electrical Characteristics (Ta = 25°C)

Product No.	Zener Voltage			Measurement Current I _Z (mA)	Zener Impedance		Temperature Coefficient of Zener Voltage α _T (mV / °C)		Forward Voltage		Reverse Current	
	V _Z (V)		r _d (Ω)		Measurement Current I _Z (mA)	Typ.	Max	V _F (V)	Measurement Current I _F (A)	I _R (μA)	Measurement Voltage V _R (V)	
	Min	Typ.		Max								Max
CRY62	5.6	6.2	6.8	10	60	10	2	3	1.0	0.2	10	3.0
CRY68	6.2	6.8	7.4	10	60	10	3	4	1.0	0.2	10	3.0
CRY82	7.4	8.2	9.0	10	30	10	4	6	1.0	0.2	10	4.9
CRZ10	9.0	10.0	11.0	10	30	10	6	9	1.0	0.2	10	6.0
CRZ12	10.8	12.0	13.2	10	30	10	8	13	1.0	0.2	10	8.0
CRZ13	11.7	13.0	14.3	10	30	10	9	14	1.0	0.2	10	9.0
CRZ15	13.5	15.0	16.5	10	30	10	11	17	1.0	0.2	10	10.0
CRZ16	14.4	16.0	17.6	10	30	10	12	19	1.0	0.2	10	11.0
CRZ18	16.2	18.0	19.8	10	30	10	14	23	1.0	0.2	10	13.0
CRZ20	18.0	20.0	22.0	10	30	10	16	26	1.0	0.2	10	14.0
CRZ24	21.6	24.0	26.4	10	30	10	20	32	1.0	0.2	10	17.0
CRZ27	24.3	27.0	29.7	10	30	10	23	36	1.0	0.2	10	19.0
CRZ30	27.0	30.0	33.0	10	30	10	25	40	1.0	0.2	10	21.0
CRZ33	29.7	33.0	36.3	10	30	10	26	41	1.0	0.2	10	26.4
CRZ36	32.4	36.0	39.6	9	30	9	28	45	1.0	0.2	10	28.8
CRZ39	35.1	39.0	42.9	8	35	8	30	48	1.0	0.2	10	31.2

Marking

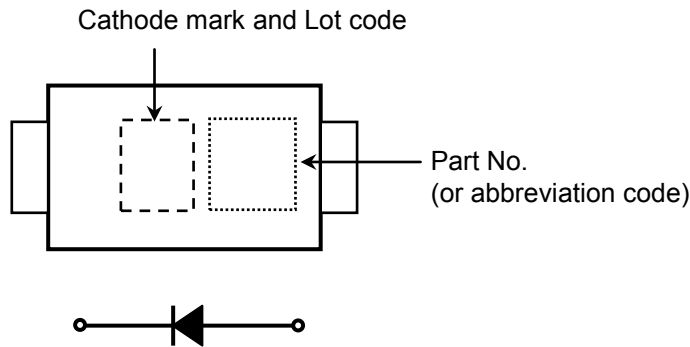

Abbreviation Code	Part No.
6.2	CRY62
6.8	CRY68
8.2	CRY82
10	CRZ10
12	CRZ12
13	CRZ13
15	CRZ15
16	CRZ16
18	CRZ18
20	CRZ20
24	CRZ24
27	CRZ27
30	CRZ30
33	CRZ33
36	CRZ36
39	CRZ39

Handling Precaution

The absolute maximum ratings denote the absolute maximum ratings, which are rated values and must not be exceeded during operation, even for an instant. The following are the general derating methods that we recommend when you design a circuit with a device.

- P: We recommend that the worst case power dissipation be no greater than 50% of the absolute maximum rating of power dissipation. Carry out adequate heat design.
- PRSM: We recommend that a device be used within the recommended area in the figure, PRSM-tw.
- T_j: Derate this rating when using a device in order to ensure high reliability. We recommend that the device be used at a T_j of below 120°C.

Thermal resistance between junction and ambient fluctuates depending on the device's mounting condition. When using a device, design a circuit board and a soldering land size to match the appropriate thermal resistance value.

Please refer to the Rectifiers databook for further information.

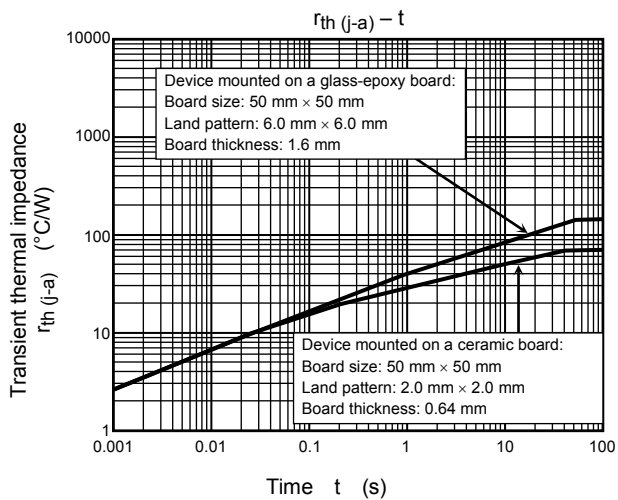
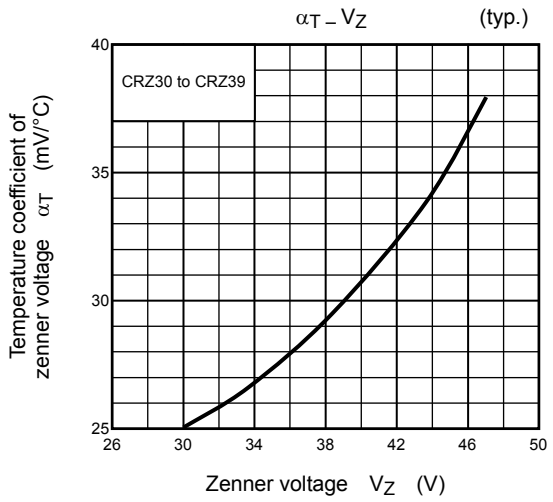
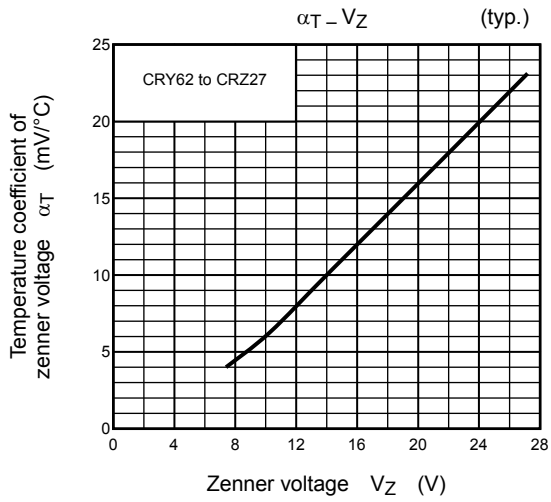
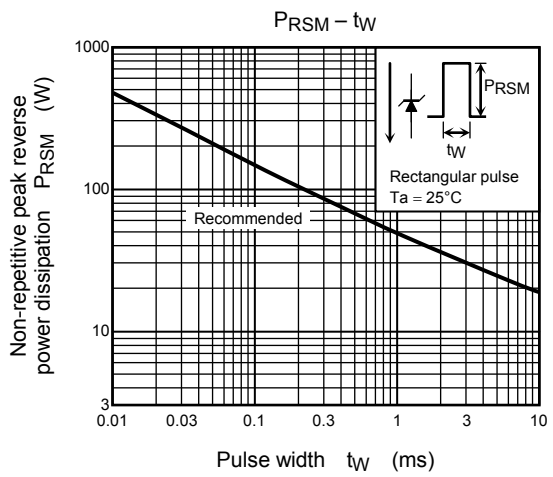
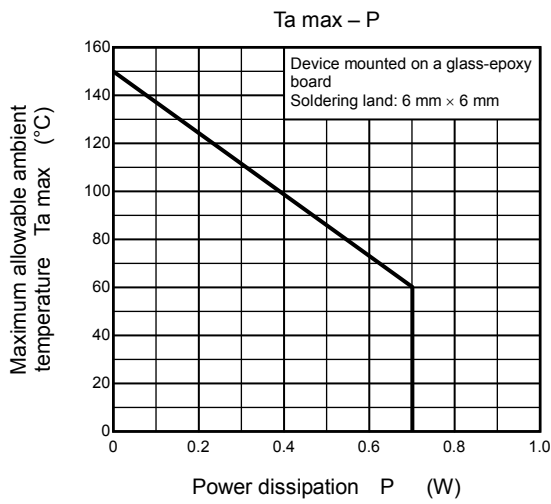

RESTRICTIONS ON PRODUCT USE

- Toshiba Corporation, and its subsidiaries and affiliates (collectively "TOSHIBA"), reserve the right to make changes to the information in this document, and related hardware, software and systems (collectively "Product") without notice.
- This document and any information herein may not be reproduced without prior written permission from TOSHIBA. Even with TOSHIBA's written permission, reproduction is permissible only if reproduction is without alteration/omission.
- Though TOSHIBA works continually to improve Product's quality and reliability, Product can malfunction or fail. Customers are responsible for complying with safety standards and for providing adequate designs and safeguards for their hardware, software and systems which minimize risk and avoid situations in which a malfunction or failure of Product could cause loss of human life, bodily injury or damage to property, including data loss or corruption. Before customers use the Product, create designs including the Product, or incorporate the Product into their own applications, customers must also refer to and comply with (a) the latest versions of all relevant TOSHIBA information, including without limitation, this document, the specifications, the data sheets and application notes for Product and the precautions and conditions set forth in the "TOSHIBA Semiconductor Reliability Handbook" and (b) the instructions for the application with which the Product will be used with or for. Customers are solely responsible for all aspects of their own product design or applications, including but not limited to (a) determining the appropriateness of the use of this Product in such design or applications; (b) evaluating and determining the applicability of any information contained in this document, or in charts, diagrams, programs, algorithms, sample application circuits, or any other referenced documents; and (c) validating all operating parameters for such designs and applications. **TOSHIBA ASSUMES NO LIABILITY FOR CUSTOMERS' PRODUCT DESIGN OR APPLICATIONS.**
- **PRODUCT IS NEITHER INTENDED NOR WARRANTED FOR USE IN EQUIPMENTS OR SYSTEMS THAT REQUIRE EXTRAORDINARILY HIGH LEVELS OF QUALITY AND/OR RELIABILITY, AND/OR A MALFUNCTION OR FAILURE OF WHICH MAY CAUSE LOSS OF HUMAN LIFE, BODILY INJURY, SERIOUS PROPERTY DAMAGE AND/OR SERIOUS PUBLIC IMPACT ("UNINTENDED USE").** Except for specific applications as expressly stated in this document, Unintended Use includes, without limitation, equipment used in nuclear facilities, equipment used in the aerospace industry, medical equipment, equipment used for automobiles, trains, ships and other transportation, traffic signaling equipment, equipment used to control combustions or explosions, safety devices, elevators and escalators, devices related to electric power, and equipment used in finance-related fields. **IF YOU USE PRODUCT FOR UNINTENDED USE, TOSHIBA ASSUMES NO LIABILITY FOR PRODUCT.** For details, please contact your TOSHIBA sales representative.
- Do not disassemble, analyze, reverse-engineer, alter, modify, translate or copy Product, whether in whole or in part.
- Product shall not be used for or incorporated into any products or systems whose manufacture, use, or sale is prohibited under any applicable laws or regulations.
- The information contained herein is presented only as guidance for Product use. No responsibility is assumed by TOSHIBA for any infringement of patents or any other intellectual property rights of third parties that may result from the use of Product. No license to any intellectual property right is granted by this document, whether express or implied, by estoppel or otherwise.
- **ABSENT A WRITTEN SIGNED AGREEMENT, EXCEPT AS PROVIDED IN THE RELEVANT TERMS AND CONDITIONS OF SALE FOR PRODUCT, AND TO THE MAXIMUM EXTENT ALLOWABLE BY LAW, TOSHIBA (1) ASSUMES NO LIABILITY WHATSOEVER, INCLUDING WITHOUT LIMITATION, INDIRECT, CONSEQUENTIAL, SPECIAL, OR INCIDENTAL DAMAGES OR LOSS, INCLUDING WITHOUT LIMITATION, LOSS OF PROFITS, LOSS OF OPPORTUNITIES, BUSINESS INTERRUPTION AND LOSS OF DATA, AND (2) DISCLAIMS ANY AND ALL EXPRESS OR IMPLIED WARRANTIES AND CONDITIONS RELATED TO SALE, USE OF PRODUCT, OR INFORMATION, INCLUDING WARRANTIES OR CONDITIONS OF MERCHANTABILITY, FITNESS FOR A PARTICULAR PURPOSE, ACCURACY OF INFORMATION, OR NONINFRINGEMENT.**
- Do not use or otherwise make available Product or related software or technology for any military purposes, including without limitation, for the design, development, use, stockpiling or manufacturing of nuclear, chemical, or biological weapons or missile technology products (mass destruction weapons). Product and related software and technology may be controlled under the applicable export laws and regulations including, without limitation, the Japanese Foreign Exchange and Foreign Trade Law and the U.S. Export Administration Regulations. Export and re-export of Product or related software or technology are strictly prohibited except in compliance with all applicable export laws and regulations.
- Please contact your TOSHIBA sales representative for details as to environmental matters such as the RoHS compatibility of Product. Please use Product in compliance with all applicable laws and regulations that regulate the inclusion or use of controlled substances, including without limitation, the EU RoHS Directive. **TOSHIBA ASSUMES NO LIABILITY FOR DAMAGES OR LOSSES OCCURRING AS A RESULT OF NONCOMPLIANCE WITH APPLICABLE LAWS AND REGULATIONS.**