



*TAIWAN TONGJIA OPTOELECTRONICS TECHNOLOGY CO., LTD*

*GUANGDONG TONGJIA OPTOELECTRONICS TECHNOLOGY CO., LTD*

## 承認書

### Specification For Approval

Customer: (客戶)

\_\_\_\_\_

Description: (產品描述)

SMD3528燈珠黃光

\_\_\_\_\_

Part number: (產品型號)

TJ-S3528UG6W9TLC9Y-A5

\_\_\_\_\_

Date: (日期)

\_\_\_\_\_

Approved By: (客戶承認)

--

Prepared By: (我司承認)

Approval	Check	Design	Sales

核准

審核

製作

業務

Customer Service Hotline: **400-676-8616**

TEL: 0769-8662 5999    0769-8200 2226

E-MAIL : dg@togialed.com

FAX: 0769-8200 2227

WEB: www.togialed.com

### Features

3.5mm x 2.8mm SMT LED, 1.9mm thickness

Low power consumption

Wide view angle

Package: 2000pcs/reel

RoHS Compliant

### Package outlines

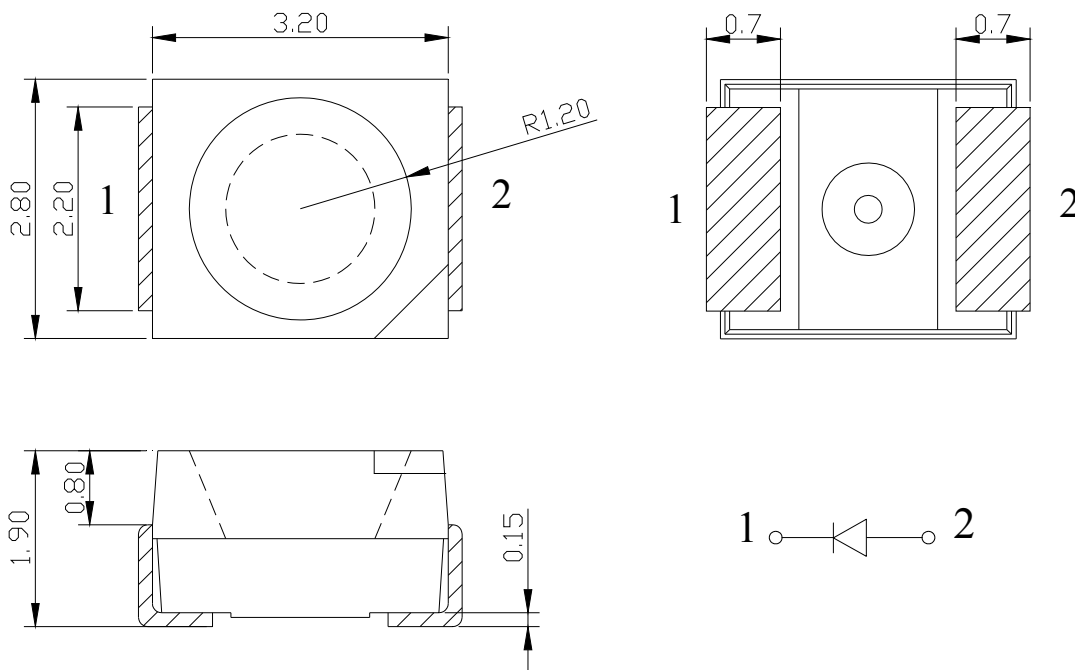

### Recommend Pad Layout

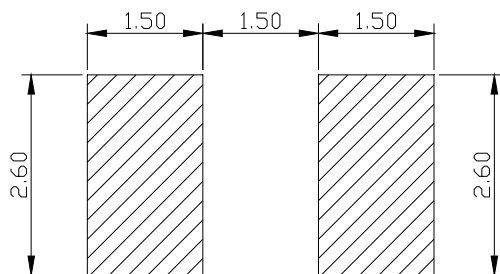

**ATTENTION**  
OBSERVE PRECAUTIONS  
FOR HANDLING  
ELECTROSTATIC  
SENSITIVE DEVICES

### Notes:

1. All dimensions are in millimeters (inches);
2. Tolerances are  $\pm 0.1\text{mm}$  (0.004inch) unless otherwise noted.

Absolute maximum ratings (TA=25°C)

Parameter	Symbol	Value	Unit
Forward current	I <sub>f</sub>	30	mA
Reverse voltage	V <sub>r</sub>	5	V
Power dissipation	P <sub>d</sub>	72	mW
Operating temperature	T <sub>op</sub>	-40 ~+80	°C
Storage temperature	T <sub>stg</sub>	-40 ~+85	°C
Peak pulsing current (1/8 duty f=1kHz)	I <sub>fp</sub>	125	mA

Electro-optical characteristics (TA=25°C)

Parameter	Test Condition	Symbol	Value			Unit
			Min	Typ	Max	
Wavelength at peak emission	I <sub>f</sub> =20mA	λ <sub>p</sub>	--	590	--	nm
Spectral half bandwidth	I <sub>f</sub> =20mA	Δλ	--	18	--	nm
Dominant wavelength	I <sub>f</sub> =20mA	λ <sub>d</sub>	585	--	595	nm
Forward voltage	I <sub>f</sub> =20mA	V <sub>f</sub>	1.8	--	2.4	V
Luminous intensity	I <sub>f</sub> =20mA	I <sub>v</sub>	300	600	900	mcd
Viewing angle at 50% I <sub>v</sub>	I <sub>f</sub> =10mA	2θ 1/2	--	120	--	Deg
Reverse current	V <sub>r</sub> =5V	I <sub>r</sub>	--	--	10	μA

### Optical characteristic curves

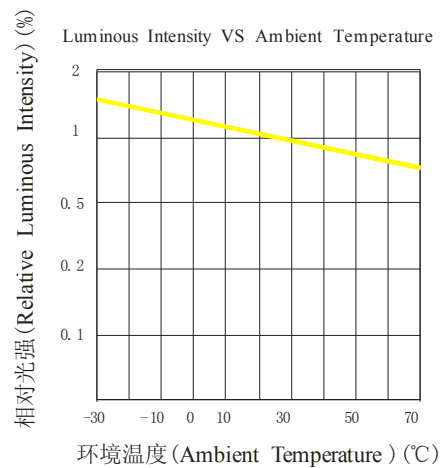
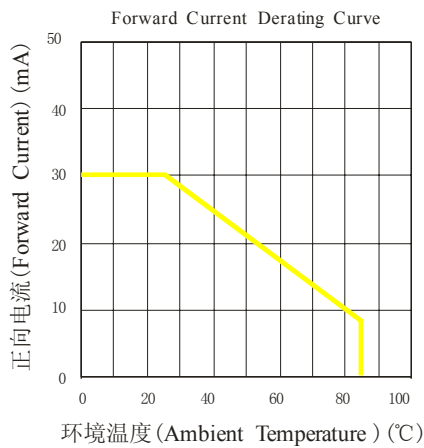
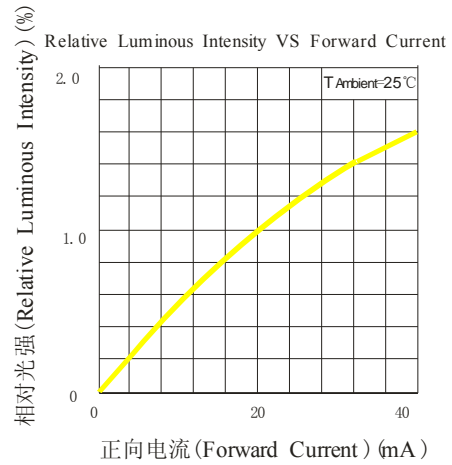
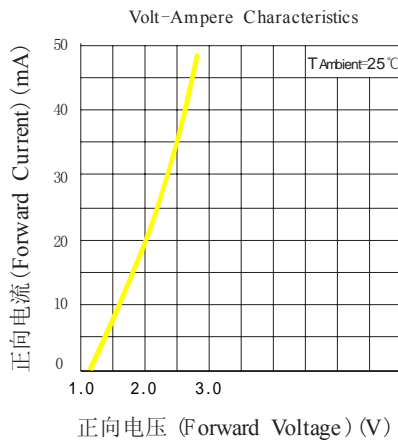
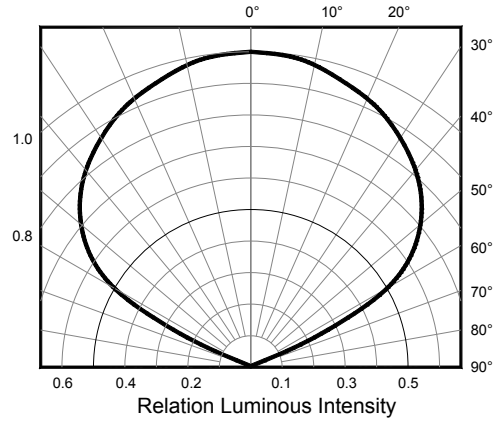
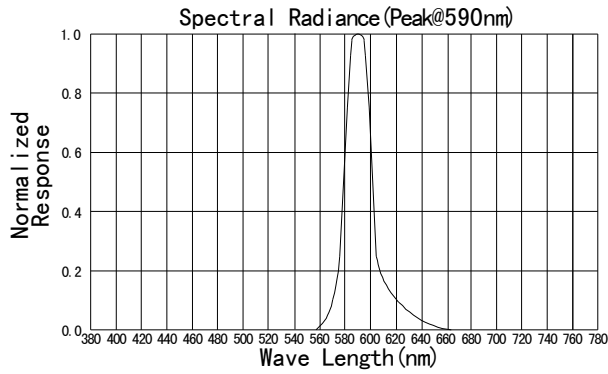

## Reflow Profile

### ■ Reflow Temp/Time

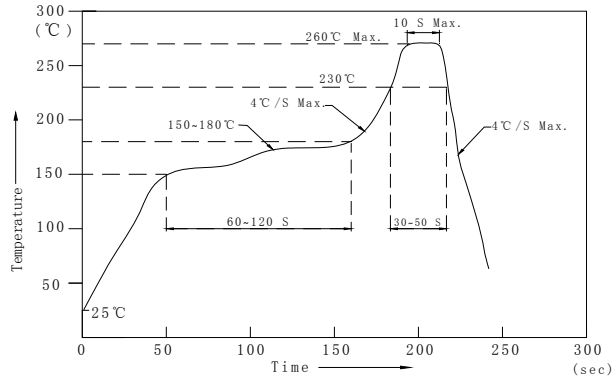

### Notes:

1. We recommend the reflow temperature 245°C (±5°C). the maximum soldering temperature should be limited to 260°C.
2. Don't cause stress to the epoxy resin while it is exposed to high temperature.
3. Number of reflow process shall be 2 times or less.

### ■ Soldering iron

Basic spec is  $\leq 5\text{sec}$  when 260°C. If temperature is higher, time should be shorter (+10°C → -1sec). Power dissipation of iron should be smaller than 20W, and temperatures should be controllable. Surface temperature of the device should be under 230°C.

### ■ Rework

1. Customer must finish rework within 5 sec under 260°C.
2. The head of iron can not touch copper foil
3. Twin-head type is preferred.

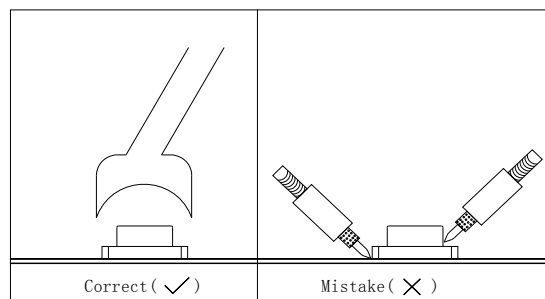

- Avoid rubbing or scraping the resin by any object, during high temperature, for example reflow solder etc.

## Test circuit and handling precautions

### ■ Test circuit



### ■ Handling precautions

#### 1. Over-current-proof

Customer must apply resistors for protection; otherwise slight voltage shift will cause big current change (Burn out will happen).

#### 2. Storage

2.1 It is recommended to store the products in the following conditions:

Humidity: 60% R.H. Max.

Temperature : 5°C~30°C(41°F~86°F)

2.2 Shelf life in sealed bag: 12 month at <5°C~30°C and <30% R.H. after the package is Opened, the products should be used within a week or they should be keeping to stored at  $\leq 20$  R.H. with zip-lock sealed.

#### 3. Baking

It is recommended to baking before soldering when the pack is unsealed after 72hrs. The Conditions are as followings:

3.1  $60 \pm 3^\circ\text{C}$  x(12~24hrs) and <5%RH, taped reel type

3.2  $100 \pm 3^\circ\text{C}$  x(45min~1hr), bulk type

3.3  $130 \pm 3^\circ\text{C}$  x(15~30min), bulk type

Test items and results of reliability

Type	Test Item	Test Conditions	Note	Number of Damaged
Environmental Sequence	Temperature Cycle	-20°C 30min ↑ ↓ 80°C 30min	100 cycle	0/22
	Thermal Shock	-20°C 15min ↑ ↓ 80°C 15min	100 cycle	0/22
	High Humidity Heat Cycle	30°C ↔ 65°C 90%RH 24hrs/1cycle	10 cycle	0/22
	High Temperature Storage	Ta=80°C	1000 hrs	0/22
	Humidity Heat Storage	Ta=60°C RH=90%	1000 hrs	0/22
	Low Temperature Storage	Ta=-30°C	1000 hrs	0/22
Operation Sequence	Life Test	Ta=25°C IF=20mA	1000 hrs	0/22
	High Humidity Heat Life Test	60°C RH=90% IF=10mA	500 hrs	0/22
	Low Temperature Life Test	Ta=-20°C IF=20mA	1000 hrs	0/22

### 3528 Series SMD LED Lamps Packaging Specifications

- Feeding Direction

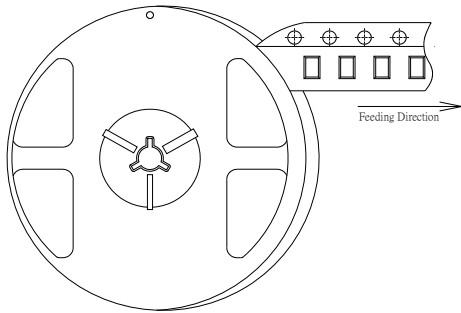

- Dimensions of Reel (Unit: mm)

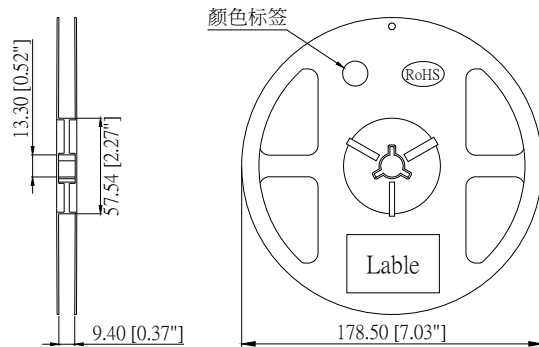

- Dimensions of Tape (Unit: mm)

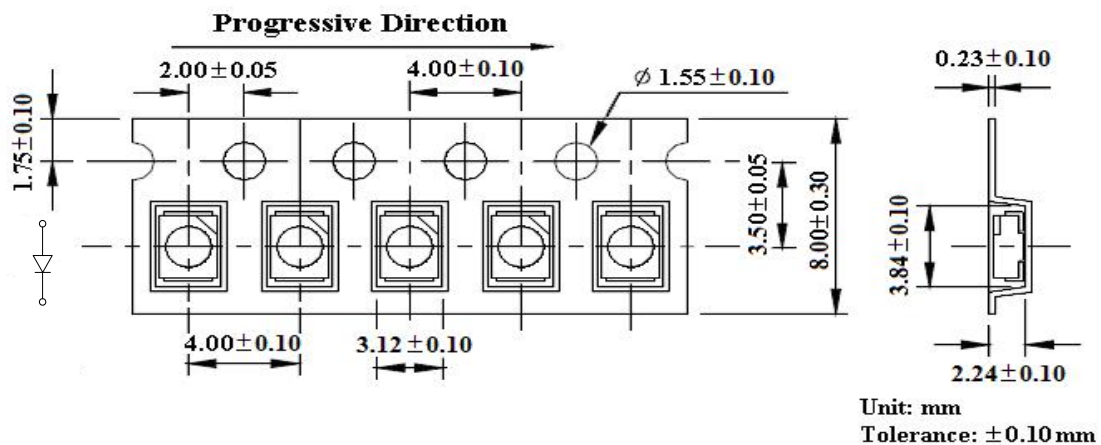

- Arrangement of Tape

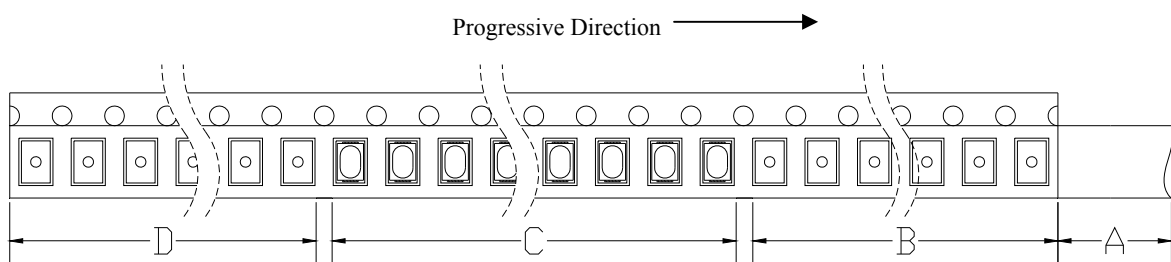

#### Notes:

1. Empty component pockets are sealed with top cover tape;
2. The maximum number of missing lamps is two;
3. The cathode is oriented towards the tape sprocket hole in accordance with ANSI/EIA RS-481 specifications.
4. 2,000 pcs/Reel.



## 3528 Series SMD LED Lamps Packaging Specifications

- Packaging specifications

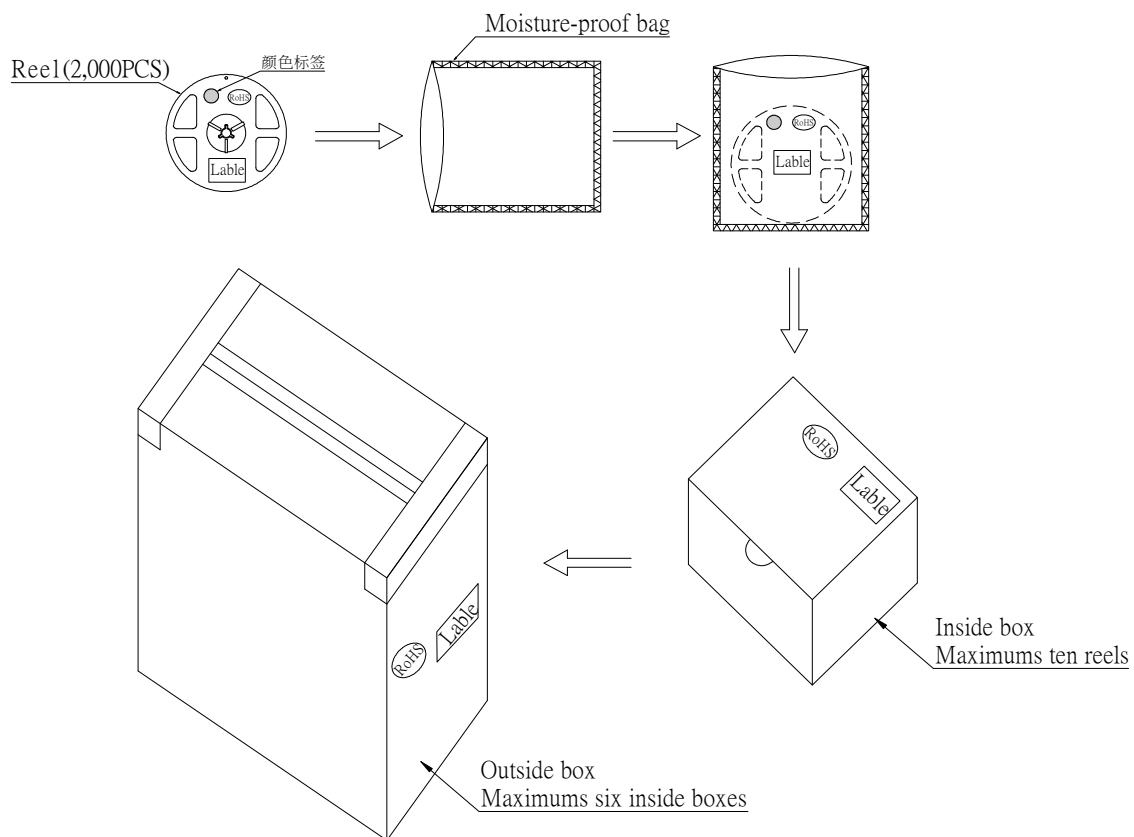

### Notes:

Reeled products (numbers of products are 2,000pcs) packed in a seal off moisture-proof bag along with a desiccant one by one, Seven moisture-proof bag of maximums (total maximum number of products are 20,000pcs) packed in an inside box (about size: 260x 220x 130mm) and four inside boxes of maximums are put in the outside box (about size: 450mm x 260mm x 400mm) Together with buffer material, and it is packed. (Part No., Lot No., quantity should appear on the label on the moisture-proof bag, part No. And quantity should appear on the label on the cardboard box.) The number of the loading steps of outside box (cardboard box) has it to three steps.