



TAIWAN TONGJIA OPTOELECTRONICS TECHNOLOGY CO., LTD

GUANGDONG TONGJIA OPTOELECTRONICS TECHNOLOGY CO., LTD

承認書

Specification For Approval

Customer: (客戶)

Description: (產品描述) 5MM圓頭透明紅翠綠無極雙色

Part number: (產品型號) TJ-L5FYTXHTNPLC2R2G-A5

Date: (日期)

Approved By: (客戶承認)

--

Prepared By: (我司承認)

Approval	Check	Design	Sales

核准

審核

製作

業務

Customer Service Hotline: **400-676-8616**

TEL: 0769-8662 5999 0769-8200 2226

E-MAIL : dg@togialed.com

FAX: 0769-8200 2227

WEB: www.togialed.com

Features :

- * Low power consumption
- * Small efficiency.
- * Versatile mounting on p.c board or panel.
- * I.C compatible/ low current requirement.
- * Package Dimensions :

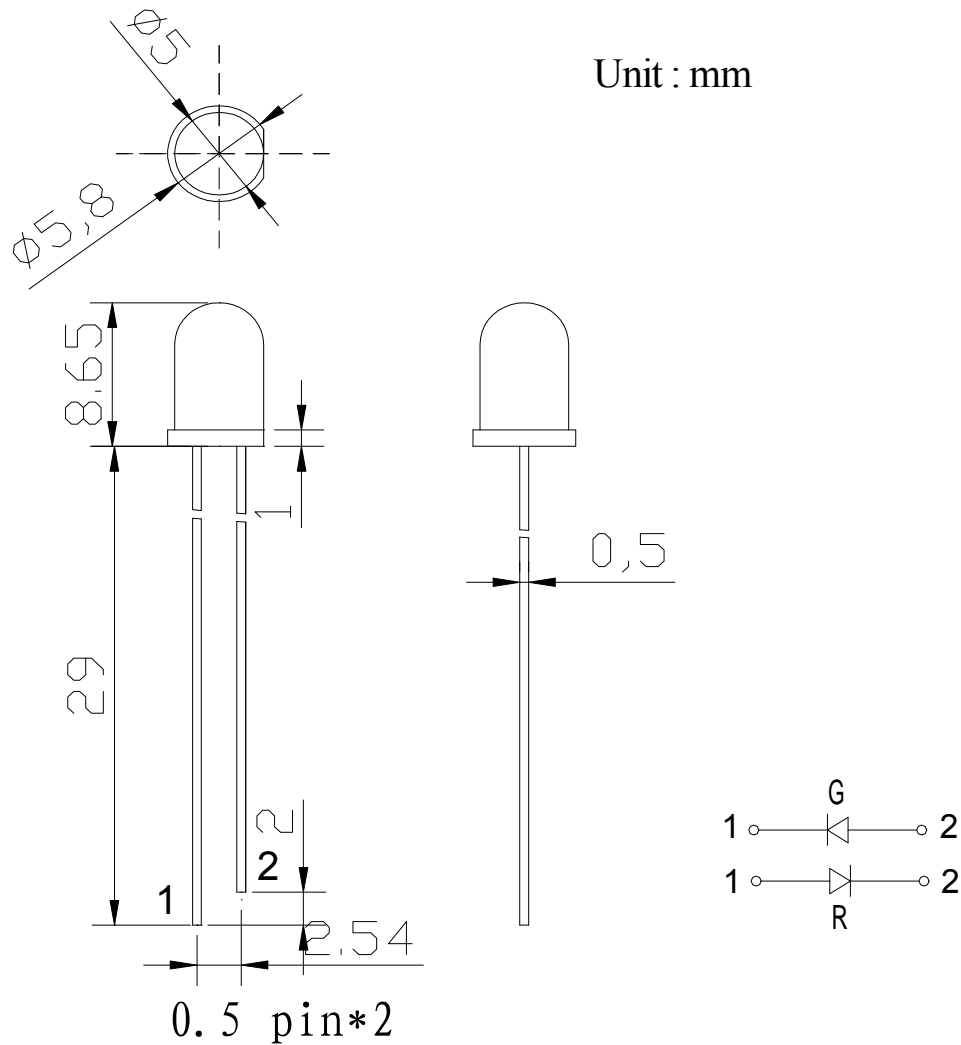

Note :

- 1 : All dimensions are in millimeters (inches).
- 2 : Tolerance is ± 0.25 mm (.010") unless otherwise noted.
- 3 : Specifications are subject to change without notices.

Absolute Maximum Ratings at Ta=25°C

Parameter	Rating	Unit
Power Dissipation(Pd)	180	mW
Peak Forward Current(1/10 Duty Cycle 0.1ms pulse Width)	100	mA
Forward Current(IF)	20	mA
Reverse Voltage(VR)	5	V
Operating Temperature Range	-20°C ~ +80°C	
Storage Temperature Range	-30°C ~ +100°C	
Lead Soldering Temperature(4.0mm Form Body)	260°C for 5 Seconds	

Electronical / Optical Charateristics at Ta=25°C

参 数		Min	Tvo	Max	Unit	Test Condition
Luminous Intensity(IV)	Red	800	-----	1500	mcd	If=20mA
	Green	4000	-----	8000	mcd	If=20mA
The wavelength	Red	620	-----	630	nm	If=20mA
	Green	515	-----	530	nm	If=20mA
Forward Voltage(VF)	Red	1.8	-----	2.6	V	If=20mA
	Green	2.8	-----	3.6	V	If=20mA
Reverse Current(IR)		-----	-----	5	μA	VR=5V

Selection Guide :

Lens color	Chip		
	Material	Emittedcolor	λ p(nm)
Water Clear	AlGaInP	Red	630
	InGaN/GaN	Green	518

Selection Guide

Typical Electrical/Optical Characteristics Curves(25°C Ambient Temperature Unle

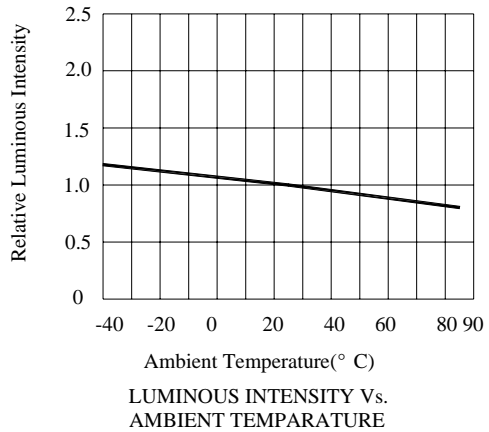
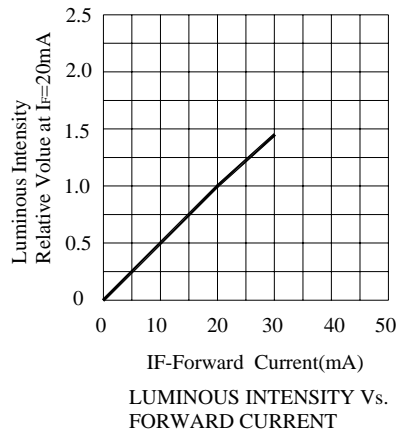
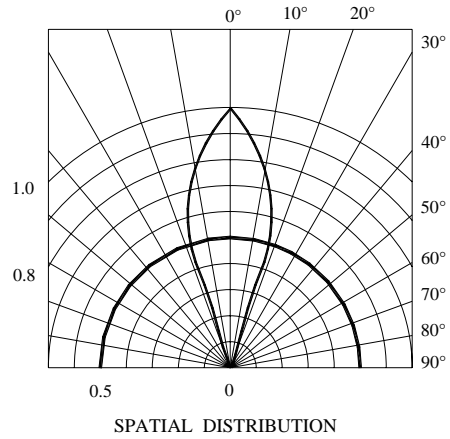

Selection Guide

Typical Electrical/Optical Characteristics Curves(25°C Ambient Temperature Unless

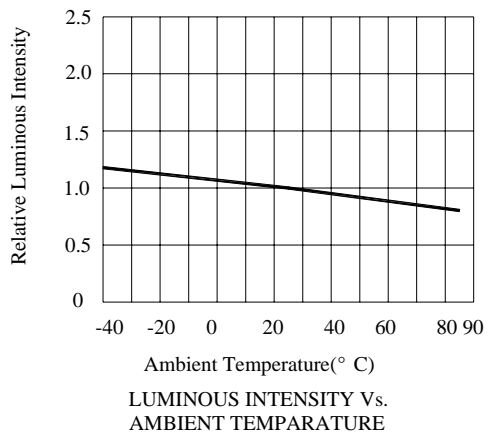
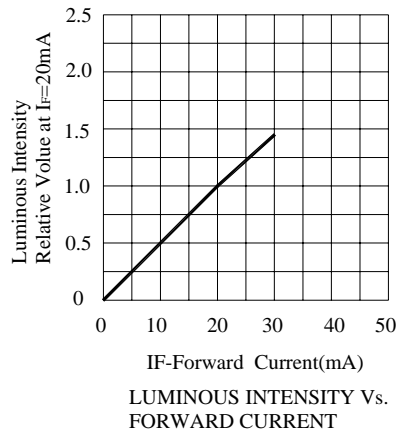
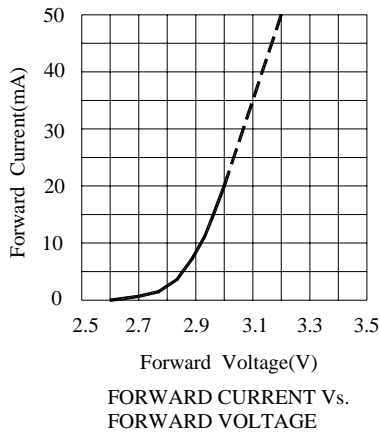
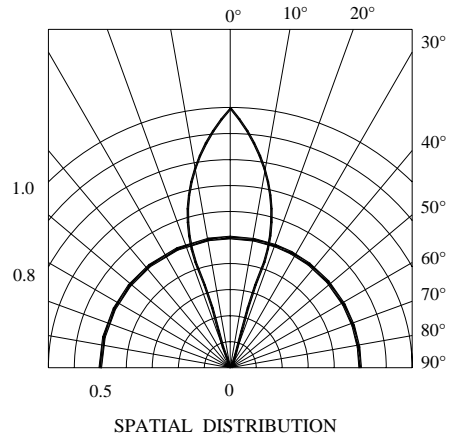
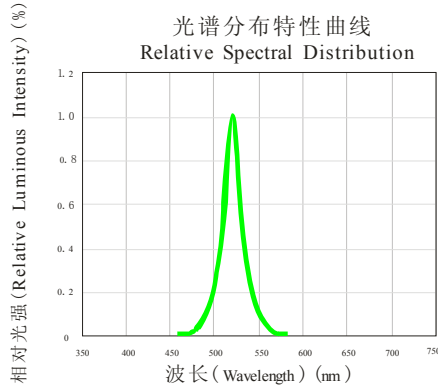

Labe

P/N: The product model

IV: Luminous intensity rank

VF: Forward voltage rank

TC: Color temperature

Q`T: number

QC: Production order

The packing

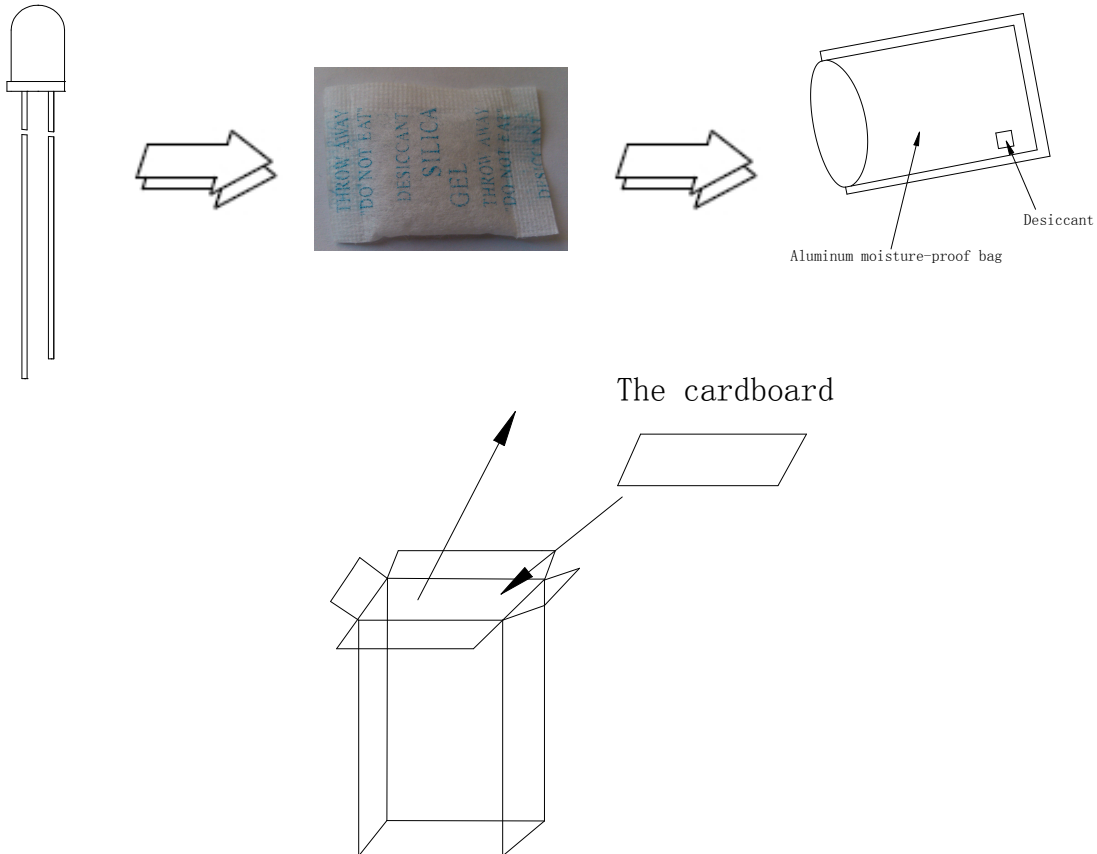

Package specification:

Package Method: packaged in anti-static bag White: Packaged in sorted light and color

1000pcs/bag General light 1000pcs/bag

note: Package specification mentioned above is under normal circumstance. Specific demand can be negotiated

Supporter shaping :

Shaping of the supporter must be conducted before welding. While shaping, the bending position of the supporter must at least be located at 3mm from the bottom of the encapsulating resin. Also, avoid multiple bending on the same position. Please choose the appropriate apparatus to fixate the supporter in order to avoid exerting extra pressure on resin. Using the jointing section of the pin and resin as fulcrum is strictly prohibited since the pressure mounted would directly damage the internal illuminating structure and thus cause irreversible deflection of the product. Due to the same reason, the interval between the welding hole on the PCB board should be strictly matched with the pin interval of the product when assembling the product.

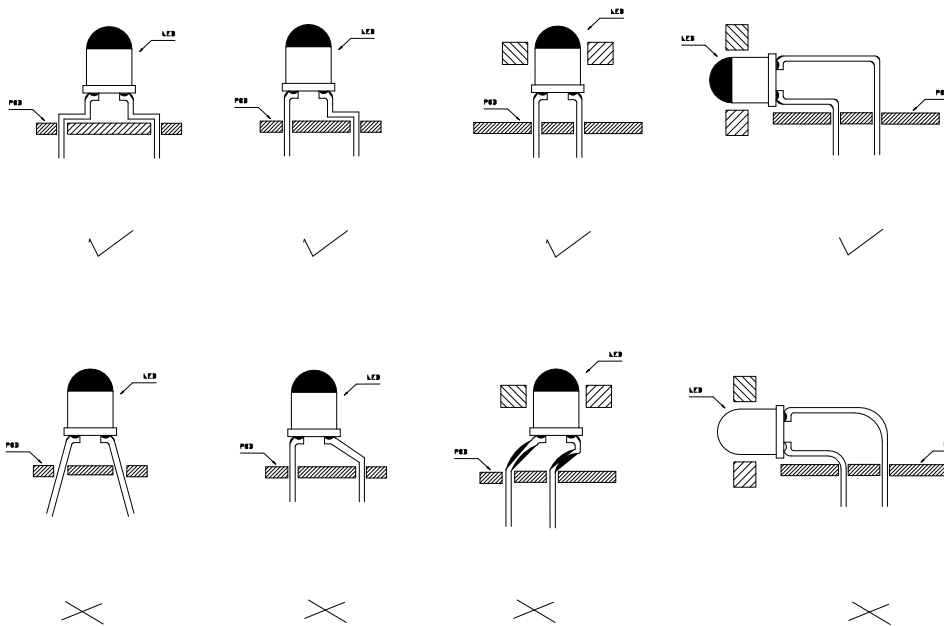

✓ correct mounting methods

✗ Incorrect mounting methods

Reliability experiment items and conditions

Serial number	Testing project	Test conditions	Sample quantity	Acceptance/rejection
1	Life test	Test current ; 20MA temperature ; 25°C Testing time ; 1000 hours	20	0/1
2	High temperature high humidity (static test)	temperature ; =+65°C humidity ; 90% RH Testing time ; 240 hours	20	0/1
3	Cold and hot impact	-40°C- +100°C 20min 10s 20min Testing time ; 100 cycle	20	0/1
4	High temperature storage	High temperature ; 100°C Testing time ; 1000 hours	20	0/1
5	Low temperature storage	Low temperature ; -40°C Testing time ; 1000 hours	20	0/1
6	temperature cycle	-40°C-- +100°C 60min 20min 60min Testing time ; 20A cycle	20	0/1
7	Reflow soldering	260°C (Max), The biggest not more than 5 seconds	20	0/1

note

Reliability experiment unqualified decision criteria

IV; Attenuation of more than 30% VF; Change more than 20% ;

1. The same project experimental results of the test must be completed within two hours
2. Testing must be in every experiment is completed. Material return to normal conditions to carry out

ESD protective

1 Electrostatic generation

1; Friction: in the daily life. Any two different material object contact after the separation, can produce a static electric · Static electricity and the most common method · Is triboelectrification ◦ The insulation material, the better · More let Easy triboelectrification ◦ In addition · Any two different material object contact after separation · Can also produce electrostatic ◦

2. Induction: in view of the conductive material is concerned, because the surface of the electronic can free flow, such as placed it in electric field because Gay repellent · Opposites attract · Are negative ions will transfer · In its surface can produce charge ◦

3. Transmission: in view of the conductive material is concerned, because the surface of the electronic can free flow · If charged object contact, will be charge transfer.

4. The harm of static electricity LED :

.1 For the moment's electric field or the heat generated by the current · Make LED local injury · For the performance of the leakage current increase quickly · Can still work · But the brightness is reduced (white light will change color), life is damaged ◦

5 Because the electric field or current failure LED insulating layer · Make device can't work (destroyed) · Performance for die lamp ◦

6; Electrostatic protection and elimination measures :

a. For the whole process (production, testing, packaging, etc.) All LED directly contact member must do it well Prevent and Eliminate electrostatic measures, basically have: workshop laid anti-static floor and well grounded ◦

b. Table for esd workstation, the production of the good earth

c. Operator wear anti-static clothing, with wrist strap, gloves or foot ring ◦

d. Application of ion fan, welding solder iron well grounding measures ◦

e. The package antistatic material
