



SOT-23 Plastic-Encapsulate MOSFETS

TF3402

TF3402 N-Channel 30-V(D-S) MOSFET

$V_{(BR)DSS}$	$R_{DS(on)MAX}$	I_D
30V	0.070Ω@10V	4.0A
	0.075Ω@4.5V	
	0.105 Ω@2.5V	

General FEATURE

- TrenchFET Power MOSFET
- Lead free product is acquired
- Surface mount package

APPLICATION

- Load Switch for Portable Devices
- DC/DC Converter

SOT-23

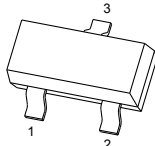

1.GATE
2.SOURCE
3.DRAIN

MARKING

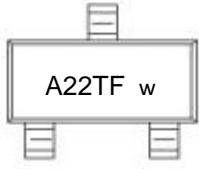

*w: week code

Equivalent Circuit

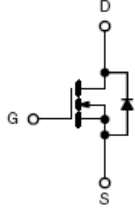

Absolute Maximum Ratings $T_A=25^{\circ}C$ unless otherwise noted				
Parameter	Symbol	Maximum	Units	
Drain-Source Voltage	V_{DS}	30	V	
Gate-Source Voltage	V_{GS}	±12	V	
Continuous Drain Current ^A	$T_A=25^{\circ}C$	I_D	A	
Pulsed Drain Current ^B				I_{DM}
Power Dissipation ^A	$T_A=25^{\circ}C$	P_D	1.25	W
Junction and Storage Temperature Range	T_J, T_{STG}	-55 to 150	°C	

Thermal Characteristics				
Parameter	Symbol	Typ	Max	Units
Maximum Junction-to-Ambient ^A	$R_{\theta JA}$	70	90	°C/W
Maximum Junction-to-Ambient ^A				
Maximum Junction-to-Ambient ^A	$R_{\theta JL}$	63	80	°C/W
Maximum Junction-to-Lead ^C				



SOT-23 Plastic-Encapsulate MOSFETS

TF3402

Electrical Characteristics (T_J=25°C unless otherwise noted)

Symbol	Parameter	Conditions	Min	Typ	Max	Units
STATIC PARAMETERS						
BV _{DSS}	Drain-Source Breakdown Voltage	I _D =250μA, V _{GS} =0V	30			V
I _{DSS}	Zero Gate Voltage Drain Current	V _{DS} =24V, V _{GS} =0V			1	μA
I _{GSS}	Gate-Body leakage current	V _{DS} =0V, V _{GS} =±12V			100	nA
V _{GS(th)}	Gate Threshold Voltage	V _{DS} =V _{GS} , I _D =250μA	0.8	1	1.6	V
I _{D(ON)}	On state drain current	V _{GS} =4.5V, V _{DS} =5V	10			A
R _{DS(ON)}	Static Drain-Source On-Resistance	V _{GS} =10V, I _D =4A		65	70	mΩ
		V _{GS} =4.5V, I _D =2.3A		70	75	mΩ
		V _{GS} =2.5V, I _D =1.5A		90	105	mΩ
g _{FS}	Forward Transconductance	V _{DS} =5V, I _D =4A		8		S
V _{SD}	Diode Forward Voltage	I _S =1A, V _{GS} =0V		0.8	1.2	V
I _S	Maximum Body-Diode Continuous Current				2.5	A
DYNAMIC PARAMETERS						
C _{iss}	Input Capacitance	V _{GS} =0V, V _{DS} =15V, f=1MHz		390		pF
C _{oss}	Output Capacitance			54.5		pF
C _{rss}	Reverse Transfer Capacitance			41		pF
R _g	Gate resistance	V _{GS} =0V, V _{DS} =0V, f=1MHz		3		Ω
SWITCHING PARAMETERS						
Q _g	Total Gate Charge	V _{GS} =4.5V, V _{DS} =15V, I _D =4A		4.34		nC
Q _{gs}	Gate Source Charge			0.6		nC
Q _{gd}	Gate Drain Charge			1.38		nC
t _{D(on)}	Turn-On DelayTime	V _{GS} =10V, V _{DS} =15V, R _L =3.75Ω, R _{GEN} =6Ω		3.3		ns
t _r	Turn-On Rise Time			1		ns
t _{D(off)}	Turn-Off DelayTime			21.7		ns
t _f	Turn-Off Fall Time			2.1		ns
t _{rr}	Body Diode Reverse Recovery Time		I _F =4A, dI/dt=100A/μs		12	
Q _{rr}	Body Diode Reverse Recovery Charge	I _F =4A, dI/dt=100A/μs		6.3		nC

A: The value of R_{θJA} is measured with the device mounted on 1in² FR-4 board with 2oz. Copper, in a still air environment with T_A=25°C. The value in any a given application depends on the user's specific board design. The current rating is based on the t≤ 10s thermal resistance rating.

B: Repetitive rating, pulse width limited by junction temperature.

C. The R_{θJA} is the sum of the thermal impedance from junction to lead R_{θJL} and lead to ambient.

D. The static characteristics in Figures 1 to 6,12,14 are obtained using 80μs pulses, duty cycle 0.5% max.

E. These tests are performed with the device mounted on 1 in² FR-4 board with 2oz. Copper, in a still air environment with T_A=25°C. The SOA curve provides a single pulse rating.

TYPICAL ELECTRICAL AND THERMAL CHARACTERISTICS

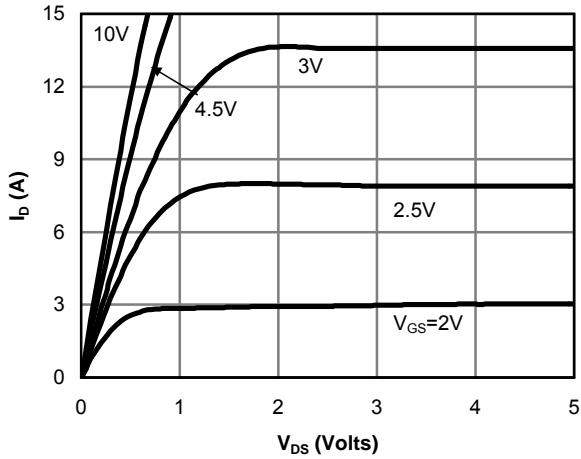

Fig 1: On-Region Characteristics

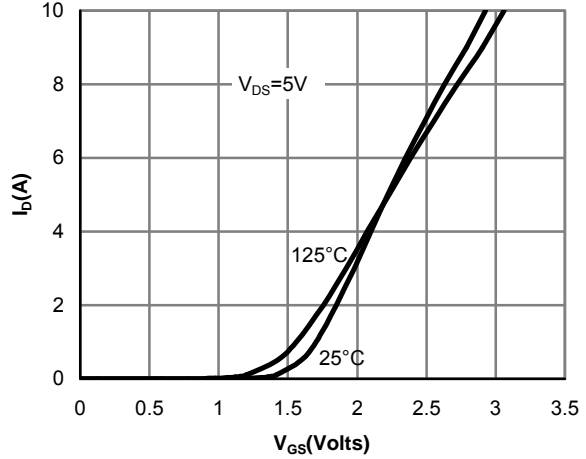

Figure 2: Transfer Characteristics

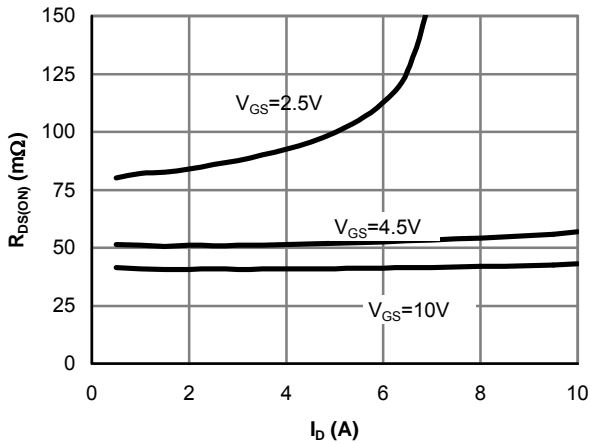

Figure 3: On-Resistance vs. Drain Current and Gate Voltage

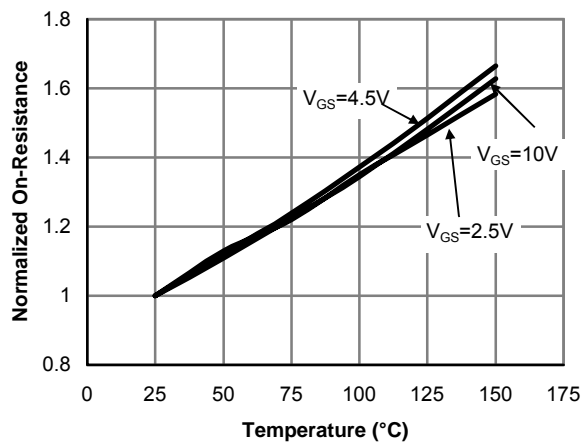

Figure 4: On-Resistance vs. Junction Temperature

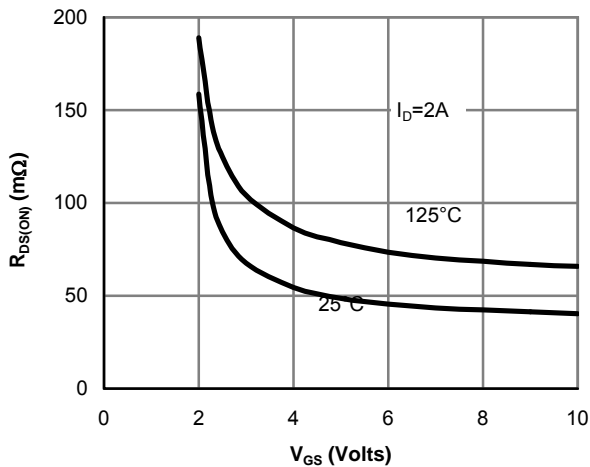

Figure 5: On-Resistance vs. Gate-Source Voltage

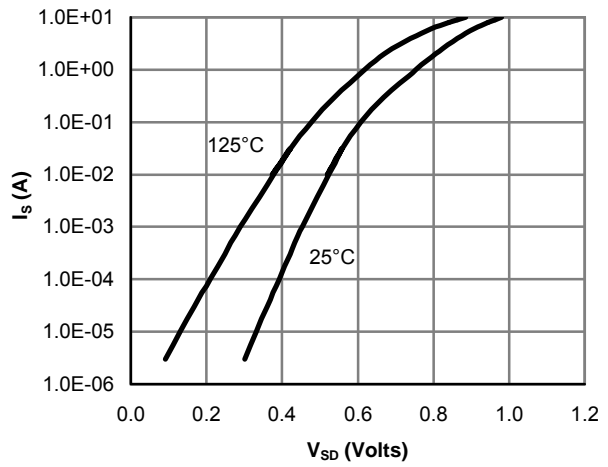

Figure 6: Body-Diode Characteristics



TYPICAL ELECTRICAL AND THERMAL CHARACTERISTICS

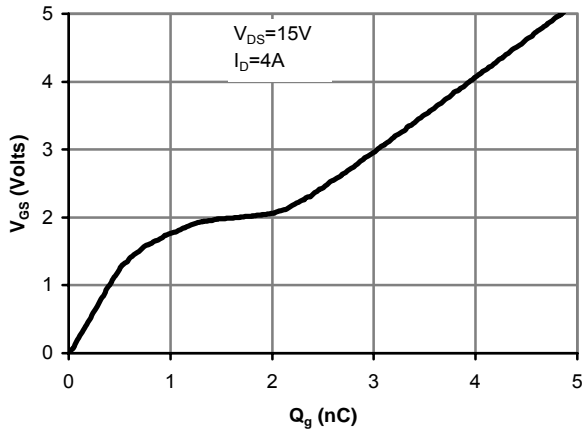

Figure 7: Gate-Charge Characteristics

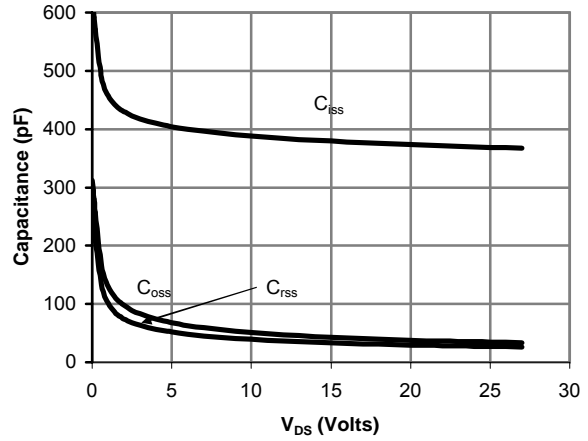

Figure 8: Capacitance Characteristics

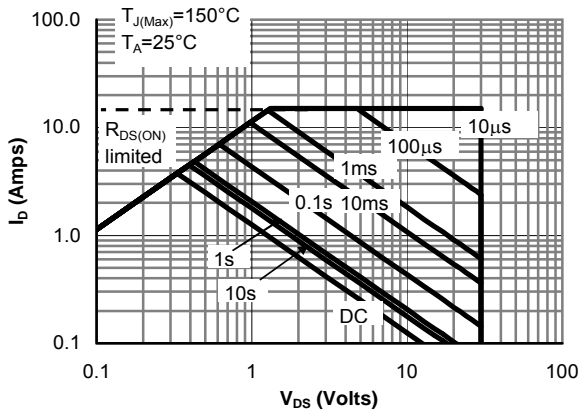

Figure 9: Maximum Forward Biased Safe Operating Area (Note E)

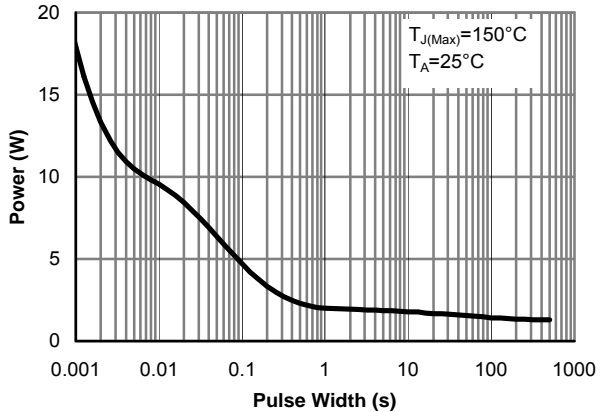

Figure 10: Single Pulse Power Rating Junction-to-Ambient (Note E)

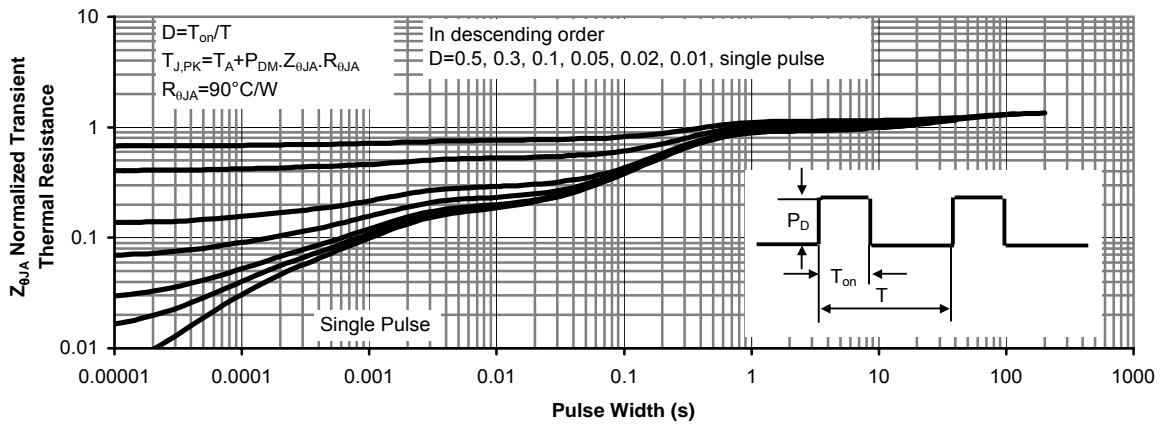
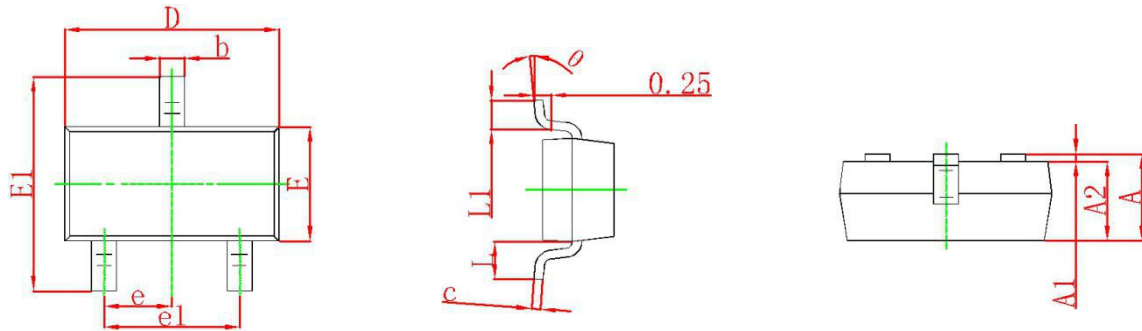

Figure 11: Normalized Maximum Transient Thermal Impedance

SOT-23 Plastic-Encapsulate MOSFETS

TF3402

SOT-23 Package Outline Dimensions



Symbol	Dimensions In Millimeters		Dimensions In Inches	
	Min	Max	Min	Max
A	0.900	1.150	0.035	0.045
A1	0.000	0.100	0.000	0.004
A2	0.900	1.050	0.035	0.041
b	0.300	0.500	0.012	0.020
c	0.080	0.150	0.003	0.006
D	2.800	3.000	0.110	0.118
E	1.200	1.400	0.047	0.055
E1	2.250	2.550	0.089	0.100
e	0.950 TYP		0.037 TYP	
e1	1.800	2.000	0.071	0.079
L	0.550 REF		0.022 REF	
L1	0.300	0.500	0.012	0.020
θ	0°	8°	0°	8°

SOT-23 Suggested Pad Layout

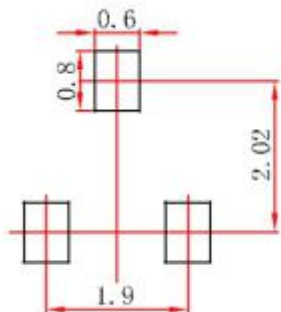

Note:

1. Controlling dimension: in millimeters.
2. General tolerance: $\pm 0.05\text{mm}$.
3. The pad layout is for reference purposes only.