

SSD6270
SSD6260
SSD6250
SSD6240

Advance Information

30 Driving x 44 Sensing
Capacitive Touch Panel Controller

This document contains information on a new product. Specifications and information herein are subject to change without notice.

<http://www.solomon-systech.com>

SSD6270

Rev 1.0

P 1/42

Mar 2015

Copyright © 2015 **Solomon Systech Limited**



Appendix: IC Revision history of SSD6270 Specification

Version	Change Items	Effective Date
1.0	Advance Information Release	24-Mar-15

CONTENTS

1	GENERAL DESCRIPTION	7
2	FEATURES	7
3	ORDERING INFORMATION	7
4	BLOCK DIAGRAM	8
5	PIN ARRANGEMENT	9
5.1	SSD6270QT6 100 PINS TQFP	9
5.2	SSD6260 88 PINS QFN	10
5.3	SSD6250 68 PINS QFN	11
5.4	SSD6240 68 PINS QFN	12
6	PIN DESCRIPTIONS	13
6.1	POWER.....	13
6.2	LOGIC	13
6.3	ANALOG	14
6.4	INPUT AND OUTPUT	14
7	FUNCTIONAL BLOCK DESCRIPTIONS	15
7.1	STYPE0, STYPE1, GPIO3	15
7.2	MCU	15
7.3	ADC	15
7.4	ANALOG BOOSTER CIRCUIT	15
7.5	IIC INTERFACE (SLAVE).....	15
7.6	44 PINS SENSING INPUT	15
7.7	30 PINS DRIVING OUTPUT AMPLIFIER	15
8	COMMAND TABLE	16
9	COMMAND DESCRIPTIONS	20
10	REGISTERS	30
11	MAXIMUM RATINGS	31
12	DC CHARACTERISTICS	31
13	AC CHARACTERISTICS	32
14	POWER UP/DOWN SEQUENCE	33
14.1	POWER UP.....	33
14.2	POWER DOWN	34
15	APPLICATION EXAMPLES	35
15.1	APPLICATION DIAGRAM	35
15.2	FPC LAYOUT EXAMPLE FOR QFP100.....	36

16 PACKAGE INFORMATION37

16.1 TQFP 100 PINS (12X12MM).....37
16.2 QFN 88 PINS (10 X 10 MM)38
16.3 QFN 68 PINS (8 X 8 MM)39
16.4 PACKAGE ORIENTATION.....40

TABLES

TABLE 3-1: ORDERING INFORMATION	7
TABLE 5-1 : SSD6270 100 PINS TQFP PIN ASSIGNMENT TABLE.....	9
TABLE 5-2 : SSD6260 88 PINS QFN PIN ASSIGNMENT TABLE.....	10
TABLE 5-3 : SSD6250 68 PINS QFN PIN ASSIGNMENT TABLE.....	11
TABLE 5-4 : SSD6240 68 PINS QFN PIN ASSIGNMENT TABLE.....	12
TABLE 11-1: MAXIMUM RATINGS (VOLTAGE REFERENCED TO V_{SS})	31
TABLE 12-1: DC CHARACTERISTICS.....	31
TABLE 13-1 : I ² C INTERFACE TIMING CHARACTERISTICS.....	32

FIGURES

FIGURE 4-1: SSD6270 BLOCK DIAGRAM	8
FIGURE 5-1: SSD6270 PIN-OUT DIAGRAM – 100 PINS TQFP (TOP VIEW).....	9
FIGURE 5-2: SSD6260 PIN-OUT DIAGRAM – 88 PINS QFN (TOP VIEW).....	10
FIGURE 5-3: SSD6250 PIN-OUT DIAGRAM – 68 PINS QFN (TOP VIEW).....	11
FIGURE 5-4: SSD6240 PIN-OUT DIAGRAM – 68 PINS QFN (TOP VIEW).....	12
FIGURE 13-1: I ² C INTERFACE TIMING CHARACTERISTICS.....	32
FIGURE 15-1: APPLICATION EXAMPLE.....	35
FIGURE 16-1 : SSD6270QT6 PACKAGE ORIENTATION.....	40
FIGURE 16-2 : SSD6260QN10 PACKAGE ORIENTATION	40
FIGURE 16-3 : SSD6250QN4/SSD6240QN4 PACKAGE ORIENTATION	41

1 GENERAL DESCRIPTION

SSD6270 series is an all in one capacitive touch panel driver that integrated the power circuits, driving and sensing circuits into a single MCU based chip. It can drive capacitive type touch panel with up to 30 driving and 44 sensing lines.

2 FEATURES

- Operating voltage for IIC communication:
 - VCI: 2.5 ~ 3.3V
 - VDDIO: 1.65 ~ 3.3V
- 6V to 8V(max.) driving voltage with external booster Caps
- 5 steps in 0.5V increment programmable driving voltage control
- 16 bit MCU core
- 4k x 16 bit RAM
- 16k x 16-bit Internal ROM
- Support ROM Patching for feature enhancement
- Support Palm rejection with 3mm passive pen (6mm or below ITO pitch CTP)
- Support 2816 x 1920 touch resolution and capable to support up to Full-HD panel
- Support 100Hz sampling rate
- Total 30 driving and 44 sensing pins
- Fully programmable driver scanning order
- 8 choices for Touch Screen Orientation control
- Provide (X,Y) coordinates and number of touch points with force index
- Support up to 10 fingers
- Automatic mode switching (Normal, Idle)
- Auto calibration for each cross-over point
- Support IIC (up to 400kbits/sec) interface for Android OS
- Supports high-ohm ITO (100kohm) up to 13-inch panel size
- Features “short I/O tester” for all sense pins
- Supports various type of panels with no ground shielding layer
- Supports various ITO patterns
- Supports pressure sensing
- Package: QFN68, QFN88, TQFP100

3 ORDERING INFORMATION

Table 3-1: Ordering Information

Ordering Part Number	Drive	Sense	Package Form	MOQ / MPQ	Remark
SSD6270QT6	30	44	TQFP-100 (Tray)	119/1190	IIC
SSD6260QN10	28	38	QFN-88 (Tray)	168/1680	IIC
SSD6250QN4	30	23	QFN-68 (Tray)	260/2600	IIC
SSD6240QN4	28	18	QFN-68 (Tray)	260/2600	IIC

4 BLOCK DIAGRAM

Figure 4-1: SSD6270 Block Diagram

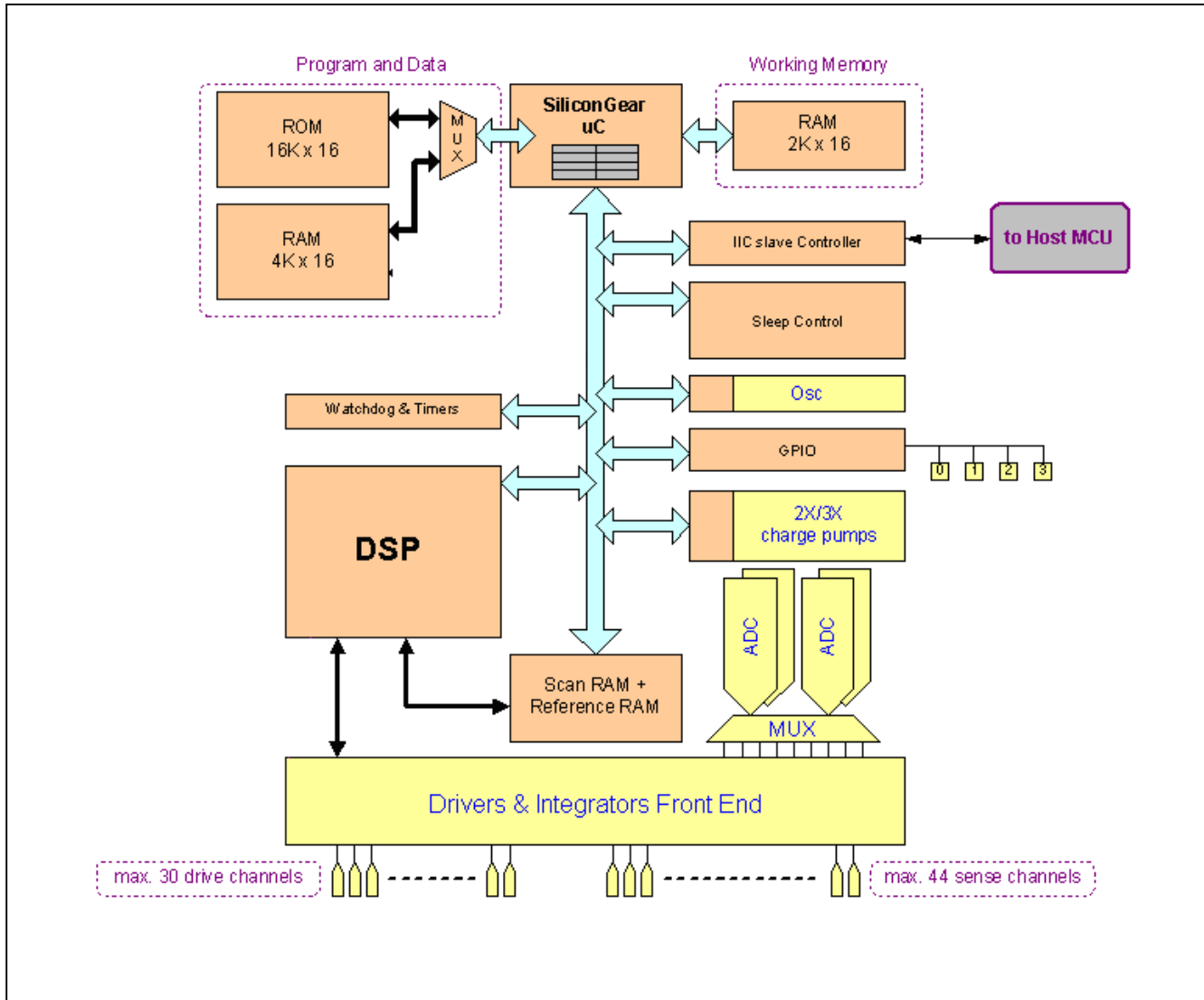

5 PIN ARRANGEMENT

5.1 SSD6270QT6 100 pins TQFP

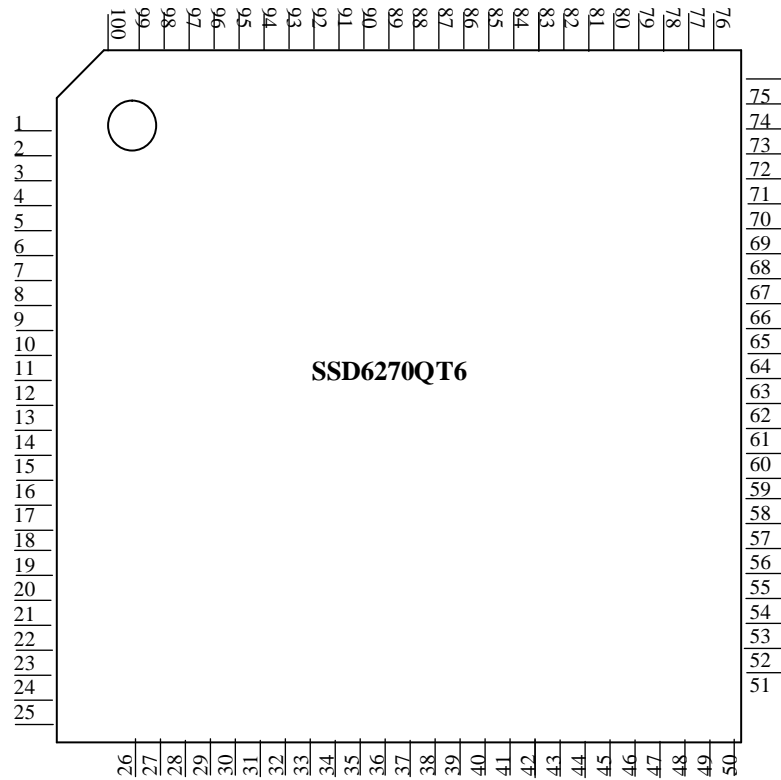

Figure 5-1: SSD6270 Pin-out Diagram – 100 pins TQFP (Top view)

Pin #	Signal Name	Pin #	Signal Name	Pin #	Signal Name	Pin #	Signal Name
1	SENSE43	26	VOUT	51	DRIVE23	76	SENSE18
2	NC	27	VCHS	52	DRIVE24	77	SENSE19
3	NC	28	DRIVE00	53	DRIVE25	78	SENSE20
4	/RESET	29	DRIVE01	54	DRIVE26	79	SENSE21
5	/IRQ	30	DRIVE02	55	DRIVE27	80	SENSE22
6	NC	31	DRIVE03	56	DRIVE28	81	SENSE23
7	NC	32	DRIVE04	57	DRIVE29	82	SENSE24
8	SLAVE_SDA	33	DRIVE05	58	SENSE00	83	SENSE25
9	SLAVE_SCL	34	DRIVE06	59	SENSE01	84	SENSE26
10	NC	35	DRIVE07	60	SENSE02	85	SENSE27
11	NC	36	DRIVE08	61	SENSE03	86	SENSE28
12	NC	37	DRIVE09	62	SENSE04	87	SENSE29
13	NC	38	DRIVE10	63	SENSE05	88	SENSE30
14	GPIO03	39	DRIVE11	64	SENSE06	89	SENSE31
15	STYPE00	40	DRIVE12	65	SENSE07	90	SENSE32
16	STYPE01	41	DRIVE13	66	SENSE08	91	SENSE33
17	VDDIO	42	DRIVE14	67	SENSE09	92	SENSE34
18	VCI	43	DRIVE15	68	SENSE10	93	SENSE35
19	BIAS	44	DRIVE16	69	SENSE11	94	SENSE36
20	AVSS	45	DRIVE17	70	SENSE12	95	SENSE37
21	VCORE	46	DRIVE18	71	SENSE13	96	SENSE38
22	C2XP	47	DRIVE19	72	SENSE14	97	SENSE39
23	C2XN	48	DRIVE20	73	SENSE15	98	SENSE40
24	C3XN	49	DRIVE21	74	SENSE16	99	SENSE41
25	C3XP	50	DRIVE22	75	SENSE17	100	SENSE42

Table 5-1 : SSD6270 100 pins TQFP Pin Assignment Table

5.2 SSD6260 88 pins QFN

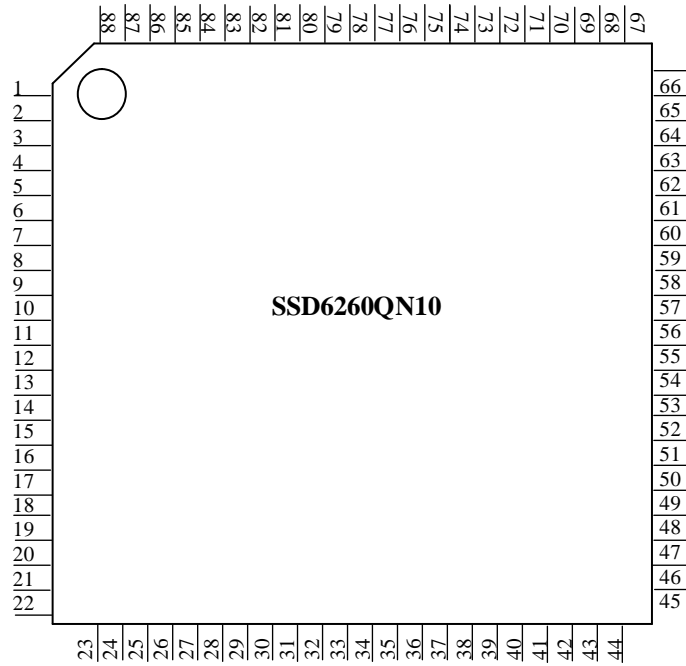

Figure 5-2: SSD6260 Pin-out Diagram – 88 pins QFN (Top view)

Pin #	Signal Name	Pin #	Signal Name	Pin #	Signal Name	Pin #	Signal Name
1	SENSE41	23	VOUT	45	DRIVE21	67	SENSE19
2	NC	24	DRIVE00	46	DRIVE22	68	SENSE20
3	NC	25	DRIVE01	47	DRIVE23	69	SENSE21
4	/RESET	26	DRIVE02	48	DRIVE24	70	SENSE22
5	/IRQ	27	DRIVE03	49	DRIVE25	71	SENSE23
6	NC	28	DRIVE04	50	DRIVE26	72	SENSE24
7	NC	29	DRIVE05	51	DRIVE27	73	SENSE25
8	SLAVE_SDA	30	DRIVE06	52	SENSE04	74	SENSE26
9	SLAVE_SCL	31	DRIVE07	53	SENSE05	75	SENSE27
10	NC	32	DRIVE08	54	SENSE06	76	SENSE28
11	NC	33	DRIVE09	55	SENSE07	77	SENSE29
12	NC	34	DRIVE10	56	SENSE08	78	SENSE30
13	STYPE	35	DRIVE11	57	SENSE09	79	SENSE31
14	VDDIO	36	DRIVE12	58	SENSE10	80	SENSE32
15	VCI	37	DRIVE13	59	SENSE11	81	SENSE33
16	BIAS	38	DRIVE14	60	SENSE12	82	SENSE34
17	AVSS	39	DRIVE15	61	SENSE13	83	SENSE35
18	VCORE	40	DRIVE16	62	SENSE14	84	SENSE36
19	C2XP	41	DRIVE17	63	SENSE15	85	SENSE37
20	C2XN	42	DRIVE18	64	SENSE16	86	SENSE38
21	C3XN	43	DRIVE19	65	SENSE17	87	SENSE39
22	C3XP	44	DRIVE20	66	SENSE18	88	SENSE40

Table 5-2 : SSD6260 88 pins QFN Pin Assignment Table

5.3 SSD6250 68 pins QFN

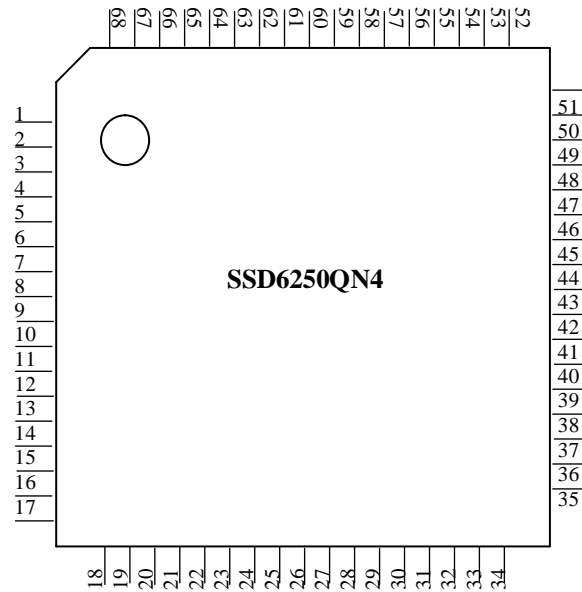

Figure 5-3: SSD6250 Pin-out Diagram – 68 pins QFN (Top view)

Pin #	Signal Name	Pin #	Signal Name	Pin #	Signal Name	Pin #	Signal Name
1	SENSE35	18	DRIVE01	35	DRIVE18	52	SENSE18
2	/RESET	19	DRIVE02	36	DRIVE19	53	SENSE19
3	/IRQ	20	DRIVE03	37	DRIVE20	54	SENSE20
4	SLAVE_SDA	21	DRIVE04	38	DRIVE21	55	SENSE21
5	SLAVE_SCL	22	DRIVE05	39	DRIVE22	56	SENSE22
6	STYPE	23	DRIVE06	40	DRIVE23	57	SENSE23
7	VDDIO	24	DRIVE07	41	DRIVE24	58	SENSE24
8	VCI	25	DRIVE08	42	DRIVE25	59	SENSE25
9	BIAS	26	DRIVE09	43	DRIVE26	60	SENSE26
10	AVSS	27	DRIVE10	44	DRIVE27	61	SENSE27
11	VCORE	28	DRIVE11	45	DRIVE28	62	SENSE28
12	C2XP	29	DRIVE12	46	DRIVE29	63	SENSE29
13	C2XN	30	DRIVE13	47	SENSE13	64	SENSE30
14	C3XN	31	DRIVE14	48	SENSE14	65	SENSE31
15	C3XP	32	DRIVE15	49	SENSE15	66	SENSE32
16	VOUT	33	DRIVE16	50	SENSE16	67	SENSE33
17	DRIVE00	34	DRIVE17	51	SENSE17	68	SENSE34

Table 5-3 : SSD6250 68 pins QFN Pin Assignment Table

5.4 SSD6240 68 pins QFN

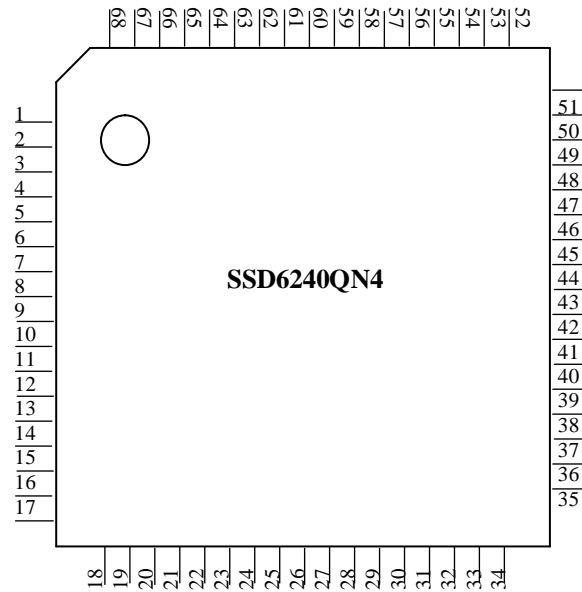

Figure 5-4: SSD6240 Pin-out Diagram – 68 pins QFN (Top view)

Pin #	Signal Name	Pin #	Signal Name	Pin #	Signal Name	Pin #	Signal Name
1	SENSE35	18	TEST PIN01	35	DRIVE18	52	SENSE18
2	/RESET	19	DRIVE02	36	DRIVE19	53	SENSE19
3	/IRQ	20	DRIVE03	37	DRIVE20	54	SENSE20
4	SLAVE_SDA	21	DRIVE04	38	DRIVE21	55	SENSE21
5	SLAVE_SCL	22	DRIVE05	39	DRIVE22	56	SENSE22
6	STYPE	23	DRIVE06	40	DRIVE23	57	SENSE23
7	VDDIO	24	DRIVE07	41	DRIVE24	58	SENSE24
8	VCI	25	DRIVE08	42	DRIVE25	59	SENSE25
9	BIAS	26	DRIVE09	43	DRIVE26	60	SENSE26
10	AVSS	27	DRIVE10	44	DRIVE27	61	SENSE27
11	VCORE	28	DRIVE11	45	DRIVE28	62	SENSE28
12	C2XP	29	DRIVE12	46	DRIVE29	63	SENSE29
13	C2XN	30	DRIVE13	47	TEST PIN02	64	SENSE30
14	C3XN	31	DRIVE14	48	TEST PIN03	65	SENSE31
15	C3XP	32	DRIVE15	49	TEST PIN04	66	SENSE32
16	VOUT	33	DRIVE16	50	TEST PIN05	67	SENSE33
17	TEST PIN00	34	DRIVE17	51	TEST PIN06	68	SENSE34

Table 5-4 : SSD6240 68 pins QFN Pin Assignment Table

6 PIN DESCRIPTIONS

Key:

I = Input

O =Output

IO = Bi-directional (input/output)

P = Power pin

Hi-Z = High impedance

6.1 Power

Pin Name	Type	RESET# State	Description
VDDIO	P	N/A	This pin is power supply input for I/O buffer
VCI	P	N/A	This pin is power supply input for analog circuit
VCHS	P	N/A	This pin is ground for Booster and HV switches
DVSS	P	N/A	This pin is ground for logic
AVSS	P	N/A	This pin is ground for analog

6.2 Logic

Pin Name	Type	RESET# State	Description															
/RESET	I	VCHS	This is Reset pin for the chip															
/IRQ	O	VDDIO	This is Interrupt pin for Interrupt request															
SLAVE_ SDA	IO	Hi-Z	IIC data pin															
SLAVE_ SCK	I	Hi-Z	IIC clock input pin															
NC	IO	Hi-Z	No Connect															
STYPE00, STYPE01	I	Hi-Z	<p>Bus interface mode selection pin. STYPE means STYPE00 and STYPE01 bonded together.</p> <table border="1"> <thead> <tr> <th>STYPE1</th> <th>STYPE0</th> <th>IIC Addr</th> </tr> </thead> <tbody> <tr> <td>0</td> <td>0</td> <td>0x48</td> </tr> <tr> <td>0</td> <td>1</td> <td>0x49</td> </tr> <tr> <td>1</td> <td>0</td> <td>0x4A</td> </tr> <tr> <td>1</td> <td>1</td> <td>0x4B</td> </tr> </tbody> </table>	STYPE1	STYPE0	IIC Addr	0	0	0x48	0	1	0x49	1	0	0x4A	1	1	0x4B
STYPE1	STYPE0	IIC Addr																
0	0	0x48																
0	1	0x49																
1	0	0x4A																
1	1	0x4B																

6.3 Analog

Pin Name	Type	RESET# State	Description
C2XP	IO	VCI/VCHS	Booster pin. Connect a capacitor to C2N
C2XN	IO	VCI/VCHS	Booster pin. Connect a capacitor to C2P
C3XP	IO	VCI/VCHS	Booster pin. Connect a capacitor to C3N
C3XN	IO	VCI/VCHS	Booster pin. Connect a capacitor to C3P
VOUT	P	VCI/VCHS	Output power supply for booster. Connect a capacitor for stabilization
BIAS	P	VCI/VCHS	Regulated voltage supply for sensor circuit. Connect a capacitor for stabilization
VCORE	P	N/A	Regulated voltage supply for logic circuit. Connect a capacitor for stabilization

6.4 Input and Output

Pin Name	Type	RESET# State	Description
SENSE00 – SENSE43	I	Hi-Z	Sensor input pins
DRIVE00 – DRIVE29	O	VCHS	Driver output pins
GPIO03	I	Hi-Z	GPIO pins

7 FUNCTIONAL BLOCK DESCRIPTIONS

7.1 STYPE0, STYPE1, GPIO3

In SSD6270, the addresses for IIC interface are listed as below. STYPE means STYPE00 and STYPE01 bonded together.

STYPE 1	STYPE 0	IIC Address
0	0	0x48
0	1	0x49
1	0	0x4A
1	1	0x4B

7.2 MCU

This block is a 16bit MCU core.

7.3 ADC

This block is an analog to digital converter for converting the sensing signal to digital data.

7.4 Analog Booster circuit

This block generates the high output driving voltage for the driving pins.

7.5 IIC interface (Slave)

This block is used to communicate with the MCU.

It supports the mandatory slave feature showed below.

- START Condition
- STOP Condition
- Acknowledge

7.6 44 pins Sensing input

This block is the sensing circuit.

7.7 30 pins driving Output Amplifier

This block is the driving output circuit.

8 COMMAND TABLE

Reg No. Hex	Name	Function	Read/Write/Command	Byte of parameter	Parameter	Default
0x00	NOP					
0x01	SW_RESET	Async software reset	W	2	0: reset the MCU and all peripherals 1: reset the MCU and all peripherals, except the Patch Controller	N/A
0x02	DEVICE_ID	Read Device ID	R	2	[15:0]: report "6270" in BCD	0x6270
0x04	SLEEP_OUT_REG	Clock is back	W	2	[15:0]: Dummy bytes	N/A
0x05	SLEEP_IN_REG	Shut down everything that is controlled by clock	W	2	[15:0]: Dummy bytes	N/A
0x06	DRIVE_SENSE_NO_REG	Set No# of Driving Electrode Set No# of Sensing Electrode	RW	2	[12:8]: Number of Drive line - 1 [5:0]: Number of Sense line - 1	0x1D2B
0x07	DRIVE_LINE0_REG	Select Drive pin, slew rate and driving group	RW	2	[13:12]: Int Group [8]: Drive line group (left/right) [7:5]: Slew rate [4:0]: Drive pin select	0x00E0
0x08	DRIVE_LINE1_REG	Select Drive pin, slew rate and driving group	RW	2	[13:12]: Int Group [8]: Drive line group (left/right) [7:5]: Slew rate [4:0]: Drive pin select	0x00E1
0x09	DRIVE_LINE2_REG	Select Drive pin, slew rate and driving group	RW	2	[13:12]: Int Group [8]: Drive line group (left/right) [7:5]: Slew rate [4:0]: Drive pin select	0x00E2
0x0A	DRIVE_LINE3_REG	Select Drive pin, slew rate and driving group	RW	2	[13:12]: Int Group [8]: Drive line group (left/right) [7:5]: Slew rate [4:0]: Drive pin select	0x00E3
0x0B	DRIVE_LINE4_REG	Select Drive pin, slew rate and driving group	RW	2	[13:12]: Int Group [8]: Drive line group (left/right) [7:5]: Slew rate [4:0]: Drive pin select	0x00E4
0x0C	DRIVE_LINE5_REG	Select Drive pin, slew rate and driving group	RW	2	[13:12]: Int Group [8]: Drive line group (left/right) [7:5]: Slew rate [4:0]: Drive pin select	0x00E5
0x0D	DRIVE_LINE6_REG	Select Drive pin, slew rate and driving group	RW	2	[13:12]: Int Group [8]: Drive line group (left/right) [7:5]: Slew rate [4:0]: Drive pin select	0x00E6
0x0E	DRIVE_LINE7_REG	Select Drive pin, slew rate and driving group	RW	2	[13:12]: Int Group [8]: Drive line group (left/right) [7:5]: Slew rate [4:0]: Drive pin select	0x00E7
0x0F	DRIVE_LINE8_REG	Select Drive pin, slew rate and driving group	RW	2	[13:12]: Int Group [8]: Drive line group (left/right) [7:5]: Slew rate [4:0]: Drive pin select	0x00E8
0x10	DRIVE_LINE9_REG	Select Drive pin, slew rate and driving group	RW	2	[13:12]: Int Group [8]: Drive line group (left/right) [7:5]: Slew rate [4:0]: Drive pin select	0x00E9
0x11	DRIVE_LINE10_REG	Select Drive pin, slew rate and driving group	RW	2	[13:12]: Int Group [8]: Drive line group (left/right) [7:5]: Slew rate [4:0]: Drive pin select	0x00EA
0x12	DRIVE_LINE11_REG	Select Drive pin, slew rate and driving group	RW	2	[13:12]: Int Group [8]: Drive line group (left/right) [7:5]: Slew rate [4:0]: Drive pin select	0x00EB
0x13	DRIVE_LINE12_REG	Select Drive pin, slew rate and driving group	RW	2	[13:12]: Int Group [8]: Drive line group (left/right) [7:5]: Slew rate [4:0]: Drive pin select	0x00EC
0x14	DRIVE_LINE13_REG	Select Drive pin, slew rate and driving group	RW	2	[13:12]: Int Group [8]: Drive line group (left/right) [7:5]: Slew rate [4:0]: Drive pin select	0x00ED
0x15	DRIVE_LINE14_REG	Select Drive pin, slew rate and driving group	RW	2	[13:12]: Int Group [8]: Drive line group (left/right) [7:5]: Slew rate [4:0]: Drive pin select	0x00EE
0x16	DRIVE_LINE15_REG	Select Drive pin, slew rate and driving group	RW	2	[13:12]: Int Group [8]: Drive line group (left/right) [7:5]: Slew rate [4:0]: Drive pin select	0x00EF
0x17	DRIVE_LINE16_REG	Select Drive pin, slew rate and driving group	RW	2	[13:12]: Int Group	0x00F0

					[8]: Drive line group (left/right) [7:5]: Slew rate [4:0]: Drive pin select	
0x18	DRIVE_LINE17_REG	Select Drive pin, slew rate and driving group	RW	2	[13:12]: Int Group [8]: Drive line group (left/right) [7:5]: Slew rate [4:0]: Drive pin select	0x00F1
0x19	DRIVE_LINE18_REG	Select Drive pin, slew rate and driving group	RW	2	[13:12]: Int Group [8]: Drive line group (left/right) [7:5]: Slew rate [4:0]: Drive pin select	0x00F2
0x1A	DRIVE_LINE19_REG	Select Drive pin, slew rate and driving group	RW	2	[13:12]: Int Group [8]: Drive line group (left/right) [7:5]: Slew rate [4:0]: Drive pin select	0x00F3
0x1B	DRIVE_LINE20_REG	Select Drive pin, slew rate and driving group	RW	2	[13:12]: Int Group [8]: Drive line group (left/right) [7:5]: Slew rate [4:0]: Drive pin select	0x00F4
0x1C	DRIVE_LINE21_REG	Select Drive pin, slew rate and driving group	RW	2	[13:12]: Int Group [8]: Drive line group (left/right) [7:5]: Slew rate [4:0]: Drive pin select	0x00F5
0x1D	DRIVE_LINE22_REG	Select Drive pin, slew rate and driving group	RW	2	[13:12]: Int Group [8]: Drive line group (left/right) [7:5]: Slew rate [4:0]: Drive pin select	0x00F6
0x1E	DRIVE_LINE23_REG	Select Drive pin, slew rate and driving group	RW	2	[13:12]: Int Group [8]: Drive line group (left/right) [7:5]: Slew rate [4:0]: Drive pin select	0x00F7
0x1F	DRIVE_LINE24_REG	Select Drive pin, slew rate and driving group	RW	2	[13:12]: Int Group [8]: Drive line group (left/right) [7:5]: Slew rate [4:0]: Drive pin select	0x00F8
0x20	DRIVE_LINE25_REG	Select Drive pin, slew rate and driving group	RW	2	[13:12]: Int Group [8]: Drive line group (left/right) [7:5]: Slew rate [4:0]: Drive pin select	0x00F9
0x21	DRIVE_LINE26_REG	Select Drive pin, slew rate and driving group	RW	2	[13:12]: Int Group [8]: Drive line group (left/right) [7:5]: Slew rate [4:0]: Drive pin select	0x00FA
0x22	DRIVE_LINE27_REG	Select Drive pin, slew rate and driving group	RW	2	[13:12]: Int Group [8]: Drive line group (left/right) [7:5]: Slew rate [4:0]: Drive pin select	0x00FB
0x23	DRIVE_LINE28_REG	Select Drive pin, slew rate and driving group	RW	2	[13:12]: Int Group [8]: Drive line group (left/right) [7:5]: Slew rate [4:0]: Drive pin select	0x00FC
0x24	DRIVE_LINE29_REG	Select Drive pin, slew rate and driving group	RW	2	[13:12]: Int Group [8]: Drive line group (left/right) [7:5]: Slew rate [4:0]: Drive pin select	0x00FD
0x25	OP_MODE_REG	Set Operating Mode	RW	2	[7:0]: Frame scan period in millisecond. 0x00 to enter IDLE mode.	0x0000
0x28	SENSE_OFFSET_REG	Change the start position of sense lines. Can be any number from 0 to 43	RW	2	[5:0]: Sense line Offset	0x0000
0x2D	INT_TIMING3_REG	Set the integration active time Set the integration delay time (must send before Drive line mapping)	RW	2	[15:8]: intg active time [7:0]: intg delay time	0x0A14
0x2E	INT_TIMING2_REG	Set the integration active time Set the integration delay time (must send before Drive line mapping)	RW	2	[15:8]: intg active time [7:0]: intg delay time	0x0A14
0x2F	INT_TIMING1_REG	Set the integration active time Set the integration delay time (must send before Drive line mapping)	RW	2	[15:8]: intg active time [7:0]: intg delay time	0x0A14
0x30	INT_TIMING0_REG	Set the integration active time Set the integration delay time (must send before Drive line mapping)	RW	2	[15:8]: intg active time [7:0]: intg delay time	0x0A14
0x33	MIN_AREA_REG	Define Min. Finger Area	RW	2	[7:0]: Min. area for a valid finger detection	0x0001
0x34	MIN_LEVEL_REG	Define Min. Finger Level	RW	2	[8:0]: Min. amplitude for a valid finger detection	0x0064
0x35	MIN_WEIGHT_REG	Define Min. Finger Weight	RW	2	[15:0]: Min. weight threshold for a valid finger detection	0x0030
0x36	MAX_AREA_REG	Define Max. Finger Area	RW	2	[7:0]: Max. area for a valid finger detection	0x0040
0x37	PRESS_SCALE_REG	Set pressure scaling factor	RW	2	[6:4]: 0: finger max level scale weight[8:1] 1: finger max level scale weight[9:2] ... 6: finger max level scale weight[14:7] 7: finger max level scale weight[15:8] [2:0]: 0: pressure scale weight[8:1] 1: pressure scale weight[9:2]	0x0003

					6: pressure scale weight[14:7] 7: pressure scale weight[15:8]	
0x65	ORIENTATION_REG	Remap finger coordinates according to different orientation	RW	2	[15:3]: Reserved [2:0]: 000: Normal 001: Y-Invert 010: X-Invert 011: X-Invert + Y-Invert 100: Transpose 101: Transpose + X-Invert (270 deg) 110: Transpose + Y-Invert (90 deg) 111: Transpose + X-Invert + Y-Invert	0x0000
0x66	X_SCALING_REG	Set scaling factor for X coordinate.	RW	2	[15:0]: X scaling factor in 0#.# # # # # # # # # # binary format.	0x4000
0x67	Y_SCALING_REG	Set scaling factor for Y coordinate.	RW	2	[15:0]: Y scaling factor in 0#.# # # # # # # # # # binary format.	0x4000
0x68	X_OFFSET_REG	Set Offset in X direction	RW	2	[15:0]: X offset in basic resolution unit. (+/-)	0x0000
0x69	Y_OFFSET_REG	Set Offset in Y direction	RW	2	[15:0]: Y offset in basic resolution unit (+/-)	0x0000
0x79	TOUCH_STATUS	Touch Status	R	2	[13]: Finger09 detected [12]: Finger08 detected [11]: Finger07 detected [10]: Finger06 detected [9]: Finger05 detected [8]: Finger04 detected [7]: Finger03 detected [6]: Finger02 detected [5]: Finger01 detected [4]: Finger00 detected [3]: Abnormal status detected [2]: Large Object detected [1]: FIFO overflow [0]: FIFO data valid	0x0000
0x7B	IRQ_MSK_REG	IRQ Mask	RW	2	[15:14]: reserved [13]: Finger09 status mask [12]: Finger08 status mask [11]: Finger07 status mask [10]: Finger06 status mask [9]: Finger05 status mask [8]: Finger04 status mask [7]: Finger03 status mask [6]: Finger02 status mask [5]: Finger01 status [4]: Finger00 status mask [3]: Abnormal status mask [2]: Large Object status mask [1]: Reserved [0]: Reserved	0xC003
0x7C	FINGER00_REG	Finger00 Coordinate	R	4	[31:24]: X-coordinate[7:0] [23:16]: Y-coordinate[7:0] [15:12]: X-coordinate [11:8] [11:8]: Y-coordinate [11:8] [7:0]: Pressure Index	0xFF 0xFF 0xFF 0x00
0x7D	FINGER01_REG	Finger01 Coordinate	R	4	[31:24]: X-coordinate[7:0] [23:16]: Y-coordinate[7:0] [15:12]: X-coordinate [11:8] [11:8]: Y-coordinate [11:8] [7:0]: Pressure Index	0xFF 0xFF 0xFF 0x00
0x7E	FINGER02_REG	Finger02 Coordinate	R	4	[31:24]: X-coordinate[7:0] [23:16]: Y-coordinate[7:0] [15:12]: X-coordinate [11:8] [11:8]: Y-coordinate [11:8] [7:0]: Pressure Index	0xFF 0xFF 0xFF 0x00
0x7F	FINGER03_REG	Finger03 Coordinate	R	4	[31:24]: X-coordinate[7:0] [23:16]: Y-coordinate[7:0] [15:12]: X-coordinate [11:8] [11:8]: Y-coordinate [11:8] [7:0]: Pressure Index	0xFF 0xFF 0xFF 0x00
0x80	FINGER04_REG	Finger04 Coordinate	R	4	[31:24]: X-coordinate[7:0] [23:16]: Y-coordinate[7:0] [15:12]: X-coordinate [11:8] [11:8]: Y-coordinate [11:8] [7:0]: Pressure Index	0xFF 0xFF 0xFF 0x00

0x81	FINGER05_REG	Finger05 Coordinate	R	4	[31:24]: X-coordinate[7:0] [23:16]: Y-coordinate[7:0] [15:12]: X-coordinate [11:8] [11:8]: Y-coordinate [11:8] [7:0]: Pressure Index	0xFF 0xFF 0xFF 0x00
0x82	FINGER06_REG	Finger06 Coordinate	R	4	[31:24]: X-coordinate[7:0] [23:16]: Y-coordinate[7:0] [15:12]: X-coordinate [11:8] [11:8]: Y-coordinate [11:8] [7:0]: Pressure Index	0xFF 0xFF 0xFF 0x00
0x83	FINGER07_REG	Finger07 Coordinate	R	4	[31:24]: X-coordinate[7:0] [23:16]: Y-coordinate[7:0] [15:12]: X-coordinate [11:8] [11:8]: Y-coordinate [11:8] [7:0]: Pressure Index	0xFF 0xFF 0xFF 0x00
0x84	FINGER08_REG	Finger08 Coordinate	R	4	[31:24]: X-coordinate[7:0] [23:16]: Y-coordinate[7:0] [15:12]: X-coordinate [11:8] [11:8]: Y-coordinate [11:8] [7:0]: Pressure Index	0xFF 0xFF 0xFF 0x00
0x85	FINGER09_REG	Finger09 Coordinate	R	4	[31:24]: X-coordinate[7:0] [23:16]: Y-coordinate[7:0] [15:12]: X-coordinate [11:8] [11:8]: Y-coordinate [11:8] [7:0]: Pressure Index	0xFF 0xFF 0xFF 0x00
0x8B	MIN_OFFSET0_REG	Set min level offset0 when finger touching	RW	2	[8:0]: min level offset0	0x0010
0x8C	MIN_OFFSET1_REG	Set min level offset1 when no finger touching	RW	2	[8:0]: min level offset1	0x0030
0xA2	INIT_RST	Reset Init Reference Procedure	RW	2	Write 0x0001 to activate the init reference procedure again	N/A
0xD5	DRIVE_LEVEL_REG	Select Driving voltage	RW	2	[7:3]: Reserved [2:0]: 0 = Reserved 1 = 6.0V 2 = 6.5V 3 = 7.0V 4 = 7.5V 5 = 8.0V 6 = Reserved 7 = Reserved	0x0003
0xD7	ADC_RANGE_SEL_REG	Select ADC Vref range	RW	2	VrefH VrefL [2:0]: 000: VCI/2 + 0.35 VCI/2 - 0.35 001: VCI/2 + 0.40 VCI/2 - 0.40 010: VCI/2 + 0.45 VCI/2 - 0.45 011: VCI/2 + 0.50 VCI/2 - 0.50 100: VCI/2 + 0.60 VCI/2 - 0.60 101: VCI/2 + 0.70 VCI/2 - 0.70 110: VCI/2 + 0.80 VCI/2 - 0.80 111: VCI/2 + 0.90 VCI/2 - 0.90	0x0004
0xD8	BIAS_RES	Select Sense line biasing resistance	RW	2	[2:0]: 0 = 5.0k 1 = 6.5k 2 = 8.3k 3 = 10.8k 4 = 14k 5 = 18k 6 = 23k 7 = 30k	0x0004
0xDB	INTG_CAP_REG	Set integrator cap value	RW	2	[2]: C12 [1]: C11 [0]: C10	0x0004

9 COMMAND DESCRIPTIONS

No Operation (R00h)

No Operation for this command.

Software Reset (R01h)

A dummy byte (e.g. 0x00) should be sent after this command for the software reset.

Read Device ID Register (R02h)

R/W	Parameter	IB7	IB6	IB5	IB4	IB3	IB2	IB1	IB0
R	1	0	1	1	0	0	0	1	0
R	2	1	0	0	1	0	0	0	0
POR		0	1	1	0	0	0	1	0
POR		1	0	0	1	0	0	0	0

This register returned the Device ID “6270h”.

System Enable (R04h)

A dummy byte (e.g. 0x00) should be sent after this command to enable the system clock.

System Disable (R05h)

A dummy byte (e.g. 0x00) should be sent after this command to disable the system clock.

Drive and Sense Line Number Register (R06h)

R/W	Parameter	IB7	IB6	IB5	IB4	IB3	IB2	IB1	IB0
RW	1	--	--	--	Drive_No				
RW	2	Sense_No							
POR		0	0	0	1	1	1	0	1
POR		0	0	1	0	1	0	1	1

The number of driving lines can be set up to maximum 30.

Drive_No	Number of Driving Lines
00000	1
00001	2
:	:
:	Step = 1
:	:
11100	29
11101	30 (default)

The number of sensing lines can be set up to maximum 44.

Sense_No	Number of Sensing Lines
000000	1
000001	2
:	:
:	Step = 1
:	:
101010	43
101011	44 (default)

Select Drive Pin for 1st Drive Line (R07h)

R/W	Parameter	IB7	IB6	IB5	IB4	IB3	IB2	IB1	IB0
RW	1	--							Group
RW	2	--			Drive pin selection				
	POR	0	0	0	0	0	0	0	0
	POR	1	1	1	0	0	0	0	0

Select Drive Pin for 2nd Drive Line (R08h)

R/W	Parameter	IB7	IB6	IB5	IB4	IB3	IB2	IB1	IB0
RW	1	--							Group
RW	2	--			Drive pin selection				
	POR	0	0	0	0	0	0	0	0
	POR	1	1	1	0	0	0	0	1

Select Drive Pin for 3rd Drive Line (R09h)

R/W	Parameter	IB7	IB6	IB5	IB4	IB3	IB2	IB1	IB0
RW	1	--							Group
RW	2	--			Drive pin selection				
	POR	0	0	0	0	0	0	0	0
	POR	1	1	1	0	0	0	1	0

Select Drive Pin for 4th Drive Line (R0Ah)

R/W	Parameter	IB7	IB6	IB5	IB4	IB3	IB2	IB1	IB0
RW	1	--							Group
RW	2	--			Drive pin selection				
	POR	0	0	0	0	0	0	0	0
	POR	1	1	1	0	0	0	1	1

Select Drive Pin for 5th Drive Line (R0Bh)

R/W	Parameter	IB7	IB6	IB5	IB4	IB3	IB2	IB1	IB0
RW	1	--							Group
RW	2	--			Drive pin selection				
	POR	0	0	0	0	0	0	0	0
	POR	1	1	1	0	0	1	0	0

Select Drive Pin for 6th Drive Line (R0Ch)

R/W	Parameter	IB7	IB6	IB5	IB4	IB3	IB2	IB1	IB0
RW	1	--							Group
RW	2	--			Drive pin selection				
	POR	0	0	0	0	0	0	0	0
	POR	1	1	1	0	0	1	0	1

Select Drive Pin for 7th Drive Line (R0Dh)

R/W	Parameter	IB7	IB6	IB5	IB4	IB3	IB2	IB1	IB0
RW	1	--							Group
RW	2	--			Drive pin selection				
	POR	0	0	0	0	0	0	0	0
	POR	1	1	1	0	0	1	1	0

Select Drive Pin for 8th Drive Line (R0Eh)

R/W	Parameter	IB7	IB6	IB5	IB4	IB3	IB2	IB1	IB0
RW	1	--							Group
RW	2	--			Drive pin selection				
	POR	0	0	0	0	0	0	0	0
	POR	1	1	1	0	0	1	1	1

Select Drive Pin for 9th Drive Line (R0Fh)

R/W	Parameter	IB7	IB6	IB5	IB4	IB3	IB2	IB1	IB0
RW	1	--							Group
RW	2	--			Drive pin selection				
	POR	0	0	0	0	0	0	0	0
	POR	1	1	1	0	1	0	0	0

Select Drive Pin for 10th Drive Line (R10h)

R/W	Parameter	IB7	IB6	IB5	IB4	IB3	IB2	IB1	IB0
RW	1	--							Group
RW	2	--			Drive pin selection				
	POR	0	0	0	0	0	0	0	0
	POR	1	1	1	0	1	0	0	1

Select Drive Pin for 11th Drive Line (R11h)

R/W	Parameter	IB7	IB6	IB5	IB4	IB3	IB2	IB1	IB0
RW	1	--							Group
RW	2	--			Drive pin selection				
	POR	0	0	0	0	0	0	0	0
	POR	1	1	1	0	1	0	1	0

Select Drive Pin for 12th Drive Line (R12h)

R/W	Parameter	IB7	IB6	IB5	IB4	IB3	IB2	IB1	IB0
RW	1	--							Group
RW	2	--			Drive pin selection				
	POR	0	0	0	0	0	0	0	0
	POR	1	1	1	0	1	0	1	1

Select Drive Pin for 13th Drive Line (R13h)

R/W	Parameter	IB7	IB6	IB5	IB4	IB3	IB2	IB1	IB0
RW	1	--							Group
RW	2	--			Drive pin selection				
	POR	0	0	0	0	0	0	0	0
	POR	1	1	1	0	1	1	0	0

Select Drive Pin for 14th Drive Line (R14h)

R/W	Parameter	IB7	IB6	IB5	IB4	IB3	IB2	IB1	IB0
RW	1	--							Group
RW	2	--			Drive pin selection				
	POR	0	0	0	0	0	0	0	0
	POR	1	1	1	0	1	1	0	1

Select Drive Pin for 15th Drive Line (R15h)

R/W	Parameter	IB7	IB6	IB5	IB4	IB3	IB2	IB1	IB0
RW	1	--							Group
RW	2	--			Drive pin selection				
	POR	0	0	0	0	0	0	0	0
	POR	1	1	1	0	1	1	1	0

Select Drive Pin for 16th Drive Line (R16h)

R/W	Parameter	IB7	IB6	IB5	IB4	IB3	IB2	IB1	IB0
RW	1	--							Group
RW	2	--			Drive pin selection				
	POR	0	0	0	0	0	0	0	0
	POR	1	1	1	0	1	1	1	1

Select Drive Pin for 17th Drive Line (R17h)

R/W	Parameter	IB7	IB6	IB5	IB4	IB3	IB2	IB1	IB0
RW	1	--							Group
RW	2	--			Drive pin selection				
	POR	0	0	0	0	0	0	0	0
	POR	1	1	1	1	0	0	0	0

Select Drive Pin for 18th Drive Line (R18h)

R/W	Parameter	IB7	IB6	IB5	IB4	IB3	IB2	IB1	IB0
RW	1	--							Group
RW	2	--			Drive pin selection				
	POR	0	0	0	0	0	0	0	0
	POR	1	1	1	1	0	0	0	1

Select Drive Pin for 19th Drive Line (R19h)

R/W	Parameter	IB7	IB6	IB5	IB4	IB3	IB2	IB1	IB0
RW	1	--							Group
RW	2	--			Drive pin selection				
	POR	0	0	0	0	0	0	0	0
	POR	1	1	1	1	0	0	1	0

Select Drive Pin for 20th Drive Line (R1Ah)

R/W	Parameter	IB7	IB6	IB5	IB4	IB3	IB2	IB1	IB0
RW	1	--							Group
RW	2	--			Drive pin selection				
	POR	0	0	0	0	0	0	0	0
	POR	1	1	1	1	0	0	1	1

Select Drive Pin for 21st Drive Line (R1Bh)

R/W	Parameter	IB7	IB6	IB5	IB4	IB3	IB2	IB1	IB0
RW	1	--							Group
RW	2	--			Drive pin selection				
	POR	0	0	0	0	0	0	0	0
	POR	1	1	1	1	0	1	0	0

Select Drive Pin for 22nd Drive Line (R1Ch)

R/W	Parameter	IB7	IB6	IB5	IB4	IB3	IB2	IB1	IB0
RW	1	--							Group
RW	2	--			Drive pin selection				
	POR	0	0	0	0	0	0	0	0
	POR	1	1	1	1	0	1	0	1

Select Drive Pin for 23rd Drive Line (R1Dh)

R/W	Parameter	IB7	IB6	IB5	IB4	IB3	IB2	IB1	IB0
RW	1	--							Group
RW	2	--			Drive pin selection				
	POR	0	0	0	0	0	0	0	0
	POR	1	1	1	1	0	1	1	0

Select Drive Pin for 24th Drive Line (R1Eh)

R/W	Parameter	IB7	IB6	IB5	IB4	IB3	IB2	IB1	IB0
RW	1	--							Group
RW	2	--			Drive pin selection				
	POR	0	0	0	0	0	0	0	0
	POR	1	1	1	1	0	1	1	1

Select Drive Pin for 25th Drive Line (R1Fh)

R/W	Parameter	IB7	IB6	IB5	IB4	IB3	IB2	IB1	IB0
RW	1	--							Group
RW	2	--			Drive pin selection				
	POR	0	0	0	0	0	0	0	0
	POR	1	1	1	1	1	0	0	0

Select Drive Pin for 26th Drive Line (R20h)

R/W	Parameter	IB7	IB6	IB5	IB4	IB3	IB2	IB1	IB0
RW	1	--							Group
RW	2	--			Drive pin selection				
	POR	0	0	0	0	0	0	0	0
	POR	1	1	1	1	1	0	0	1

Select Drive Pin for 27th Drive Line (R21h)

R/W	Parameter	IB7	IB6	IB5	IB4	IB3	IB2	IB1	IB0
RW	1	--							Group
RW	2	--			Drive pin selection				
	POR	0	0	0	0	0	0	0	0
	POR	1	1	1	1	1	0	1	0

Select Drive Pin for 28th Drive Line (R22h)

R/W	Parameter	IB7	IB6	IB5	IB4	IB3	IB2	IB1	IB0
RW	1	--							Group
RW	2	--			Drive pin selection				
	POR	0	0	0	0	0	0	0	0
	POR	1	1	1	1	1	0	1	1

Select Drive Pin for 29th Drive Line (R23h)

R/W	Parameter	IB7	IB6	IB5	IB4	IB3	IB2	IB1	IB0
RW	1	--							Group
RW	2	--			Drive pin selection				
	POR	0	0	0	0	0	0	0	0
	POR	1	1	1	1	1	1	0	0

Select Drive Pin for 30th Drive Line (R24h)

R/W	Parameter	IB7	IB6	IB5	IB4	IB3	IB2	IB1	IB0
RW	1	--							Group
RW	2	--			Drive pin selection				
	POR	0	0	0	0	0	0	0	0
	POR	1	1	1	1	1	1	0	1

Operation Mode Register (R25h)

R/W	Parameter	IB7	IB6	IB5	IB4	IB3	IB2	IB1	IB0
RW	1	--	--	--	--	--	--	--	--
RW	2	Op_Mode							
	POR	0	0	0	0	0	0	0	0
	POR	0	0	0	0	0	0	0	0

Idle Mode - In Idle Mode, no scanning activities will be performed. Set 0 to enter idle mode.

Operation Mode - In Operation Mode, the frame scan rate is 0~100Hz. Any value >0 will be interrupted as frame period in milliseconds.

When reading, this command is used to check when the controller change from Idle Mode to Operating Mode (or vice versa):

- (1) When going from Idle Mode to Operating Mode, this command will report 0x00 until charge bump is ready.
- (2) When going from Operating Mode to Idle Mode, this command will report previous set value until the completion of frame scan.

Sense Line Offset Register (R28h)

R/W	Parameter	IB7	IB6	IB5	IB4	IB3	IB2	IB1	IB0
RW	1	--	--	--	--	--	--	--	--
RW	2	--	--	Sense_Offset					
POR		0	0	0	0	0	0	0	0
POR		0	0	0	0	0	0	0	0

Number of sense lines must be reduced accordingly.

For example, if the number of sense lines is 30 with offset is 4, the sense lines [4:33] are used.

Integration Window Timing Setting 3 (R2Dh)

R/W	Parameter	IB7	IB6	IB5	IB4	IB3	IB2	IB1	IB0
RW	1	Intg Active Time							
RW	2	Intg Delay Time							
POR		0	0	0	0	1	0	1	0
POR		0	0	0	1	0	1	0	0

Integration unit is in 62.5ns per division.

Integration Window Timing Setting 2 (R2Eh)

R/W	Parameter	IB7	IB6	IB5	IB4	IB3	IB2	IB1	IB0
RW	1	Intg Active Time							
RW	2	Intg Delay Time							
POR		0	0	0	0	1	0	1	0
POR		0	0	0	1	0	1	0	0

Integration unit is in 62.5ns per division.

Integration Window Timing Setting 1 (R2Fh)

R/W	Parameter	IB7	IB6	IB5	IB4	IB3	IB2	IB1	IB0
RW	1	Intg Active Time							
RW	2	Intg Delay Time							
POR		0	0	0	0	1	0	1	0
POR		0	0	0	1	0	1	0	0

Integration unit is in 62.5ns per division.

Integration Window Timing Setting 0 (R30h)

R/W	Parameter	IB7	IB6	IB5	IB4	IB3	IB2	IB1	IB0
RW	1	Intg Active Time							
RW	2	Intg Delay Time							
POR		0	0	0	0	1	0	1	0
POR		0	0	0	1	0	1	0	0

Integration unit is in 62.5ns per division.

Min Finger Area Setting Register (R33h)

R/W	Parameter	IB7	IB6	IB5	IB4	IB3	IB2	IB1	IB0
RW	1	--	--	--	--	--	--	--	--
RW	2	Min_Area							
POR		0	0	0	0	0	0	0	0
POR		0	0	0	0	0	0	0	1

If the touching area detected is bigger than Min_Area, the system will report “valid finger”.

Min Finger Level Setting Register (R34h)

R/W	Parameter	IB7	IB6	IB5	IB4	IB3	IB2	IB1	IB0
RW	1	--	--	--	--	--	--	--	--
RW	2	Min_Level							
POR		0	0	0	0	0	0	0	0
POR		0	1	1	0	0	1	0	0

If the touching level detected is bigger than Min_Level, the system will report “valid finger”.

Min Finger Weight Setting Register (R35h)

R/W	Parameter	IB7	IB6	IB5	IB4	IB3	IB2	IB1	IB0
RW	1	Min_Weight							
RW	2	Min_Weight							

POR	0	0	0	0	0	0	0	0	0
POR	0	0	0	0	0	0	0	0	1

Similar to Min Finger Area, user can define also the weight of a valid finger touch.

Weight means the summation of the signal level within the touch area. Weight is as a function of finger area (R33h) and finger level (R34h).

Max Finger Area Setting Register (R36h)

R/W	Parameter	IB7	IB6	IB5	IB4	IB3	IB2	IB1	IB0
RW	1	--	--	--	--	--	--	--	--
RW	2	Max_Area							
POR		0	0	0	0	0	0	0	0
POR		0	0	0	1	1	0	0	0

For any touching detected, the system will count the cover area of the touch point and determine if it is a valid finger touch. If the touching area is over Max_Area, the system will report Large Object rather than a finger touch.

Hopping Level Register (R50h)

R/W	Parameter	IB7	IB6	IB5	IB4	IB3	IB2	IB1	IB0
RW	1	Hopping_lv							
RW	2	Hopping_lv							
POR		0	0	0	0	0	0	0	0
POR		0	0	0	0	0	0	0	0

Pressure Scaling Register (R57h)

R/W	Parameter	IB7	IB6	IB5	IB4	IB3	IB2	IB1	IB0
RW	1	--	--	--	--	--	--	--	--
RW	2	Press_factor							
POR		0	0	0	0	0	0	0	0
POR		0	0	0	0	0	0	1	1

Orientation Register (R65h)

R/W	Parameter	IB7	IB6	IB5	IB4	IB3	IB2	IB1	IB0
RW	1	--	--	--	--	--	--	--	--
RW	2	Orientation							
POR		0	0	0	0	0	0	0	0
POR		0	0	0	0	0	0	0	0

Orientation	Description
000	Normal
001	Y-invert
010	X-invert
011	X-invert + Y-invert
100	Transpose
101	Transpose + X-invert
110	Transpose + Y-invert
111	Transpose + X-invert + Y-invert

X Scaling Register (R66h)

R/W	Parameter	IB7	IB6	IB5	IB4	IB3	IB2	IB1	IB0
RW	1	X_scaling							
RW	2	X_scaling							
POR		0	1	0	0	0	0	0	0
POR		0	0	0	0	0	0	0	0

Y Scaling Register (R67h)

R/W	Parameter	IB7	IB6	IB5	IB4	IB3	IB2	IB1	IB0
RW	1	Y_scaling							
RW	2	Y_scaling							
POR		0	1	0	0	0	0	0	0
POR		0	0	0	0	0	0	0	0

X Offset Register (R68h)

R/W	Parameter	IB7	IB6	IB5	IB4	IB3	IB2	IB1	IB0
RW	1	X_offset							
RW	2	X_offset							
POR		0	0	0	0	0	0	0	0
POR		0	0	0	0	0	0	0	0

Y Offset Register (R69h)

R/W	Parameter	IB7	IB6	IB5	IB4	IB3	IB2	IB1	IB0
RW	1	Y_offset							
RW	2	Y_offset							
POR		0	0	0	0	0	0	0	0
POR		0	0	0	0	0	0	0	0

Touch Status (R79h)

R/W	Parameter	IB7	IB6	IB5	IB4	IB3	IB2	IB1	IB0
R	1	--		F9	F8	F7	F6	F5	F4
R	2	F3	F2	F1	F0	AS	LO	--	
POR		0	0	0	0	0	0	0	0
POR		0	0	0	0	0	0	0	0

This register showed the status of the touch detection. When a touch event is detected, the IRQ signal will set to low and at least one bit on this register will set to “1” to indicate the touch status. This register is “0” if the IRQ signal is high.

Register	Name	Function
F9	Finger9 Detected	This bit will set to “1” indicating the present of 10 th finger
F8	Finger8 Detected	This bit will set to “1” indicating the present of 9 th finger
F7	Finger7 Detected	This bit will set to “1” indicating the present of 8 th finger
F6	Finger6 Detected	This bit will set to “1” indicating the present of 7 th finger
F5	Finger5 Detected	This bit will set to “1” indicating the present of 6 th finger
F4	Finger4 Detected	This bit will set to “1” indicating the present of 5 th finger
F3	Finger3 Detected	This bit will set to “1” indicating the present of 4 th finger
F2	Finger2 Detected	This bit will set to “1” indicating the present of 3 rd finger
F1	Finger1 Detected	This bit will set to “1” indicating the present of 2 nd finger
F0	Finger0 Detected	This bit will set to “1” when 1 st finger touch detected
AS	Abnormal status	This bit will set to “1” when abnormal status detected.
LO	Large Object	If a touch detected with touch area over Max Finger Area (R16h), this bit will set to “1”

IRQ Mask (R7Bh)

R/W	Parameter	IB7	IB6	IB5	IB4	IB3	IB2	IB1	IB0
RW	1	---		F9	F8	F7	F6	F5	F4
RW	2	F3	F2	F1	F0	AS	LO	OF	VF
POR		1	1	0	0	0	0	0	0
POR		0	0	0	0	0	0	1	1

Finger01-10 (X,Y) coordinates, press weight index. (R7Ch – R85h)

R/W	Parameter	IB7	IB6	IB5	IB4	IB3	IB2	IB1	IB0
R	1	x-coor[7:0]							
R	2	y-coor[7:0]							
R	3	x-coor[11:8]				y-coor[11:8]			
R	4	weight index[7:0]							
POR	1	1	1	1	1	1	1	1	1
	2	1	1	1	1	1	1	1	1
	3	1	1	1	1	1	1	1	1
	4	0	0	0	0	0	0	0	0

SSD6270 can detect maximum of 10 fingers touch on the panel. Ten registers are used to report the x-y coordinate of the 10 fingers if present and only the most concurrent coordinates are reported.

The first touch point will put to R7Ch and the second touch point will put to R7Dh and so on. Once the finger number had been assigned, the system will keep tracking the same finger and update the latest x-y coordinate to same register until the finger leaving the touch screen.

Reset Init Reference Procedure (RA2h)

A 0x0001 should be sent after this command to activate the init reference procedure again

Select Driving voltage level (RD5h)

R/W	Parameter	IB7	IB6	IB5	IB4	IB3	IB2	IB1	IB0
RW	1	--	--	--	--	--	--	--	--
RW	2	Reserved				DVL			
POR		0	0	0	0	0	0	0	0
POR		0	0	0	0	0	0	1	1

This register controls the output voltage of the driving line (5.5V to 9V).

DVL	Drive Line voltage
000	Reserved
001	6.0V
010	6.5V
011	7.0V
100	7.5V
101	8.0V
110	Reserved
111	Reserved

Select ADC Vref range (RD7h)

R/W	Parameter	IB7	IB6	IB5	IB4	IB3	IB2	IB1	IB0	
RW	1	--	--	--	--	--	--	--	--	
RW	2	--					Vref			
	POR	0	0	0	0	0	0	0	0	
	POR	0	0	0	0	0	1	0	0	

Vref	VrefH	VrefL
000	VCI/2+0.35	VCI/2-0.35
001	VCI/2+0.40	VCI/2-0.40
010	VCI/2+0.45	VCI/2-0.45
011	VCI/2+0.50	VCI/2-0.50
100	VCI/2+0.60	VCI/2-0.60
101	VCI/2+0.70	VCI/2-0.70
110	VCI/2+0.80	VCI/2-0.80
111	VCI/2+0.90	VCI/2-0.90

Select Sense line biasing resistance (RD8h)

R/W	Parameter	IB7	IB6	IB5	IB4	IB3	IB2	IB1	IB0	
RW	1	--	--	--	--	--	--	--	--	
RW	2	--					BIAS_RES			
	POR	0	0	0	0	0	0	0	0	
	POR	0	0	0	0	0	1	0	0	

Setting the sense line biasing resistance

BIAS_RES	Resistance
000	5.0k
001	6.5k
010	8.3k
011	10.8k
100	14k
101	18k
110	23k
111	30k

Set integrator cap value (RDBh)

R/W	Parameter	IB7	IB6	IB5	IB4	IB3	IB2	IB1	IB0
RW	1	--	--	--	--	--	--	--	--
RW	2	--					CI2	CI1	CI0
	POR	0	0	0	0	0	0	0	0
	POR	0	0	0	0	0	1	0	0

REGISTERS

VDDIO = VCI = 2.775V

- 1.) Hardware Reset
- 2.) Set the number of driver lines.
- 3.) Set the number of sense lines.
- 4.) Set the driver line scanning order.
- 5.) Turn on the booster circuit and set the VOUT to ~7.0V.

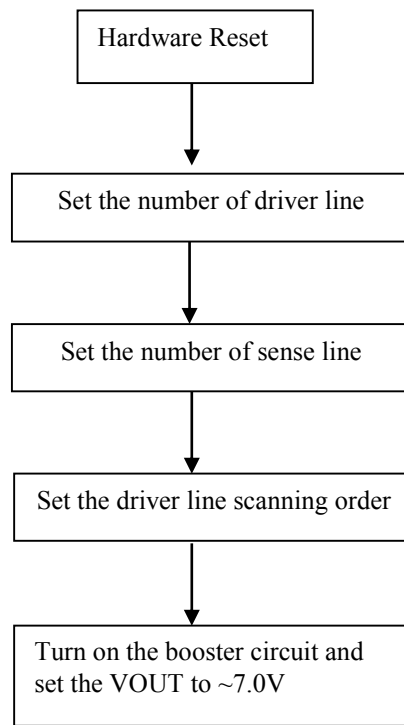

10 MAXIMUM RATINGS

Symbol	Parameter	Value	Unit
V _{CORE}	Supply Voltage for Logic	-0.3 to +2.0	V
V _{DDIO}	Supply Voltage for I/O	-0.3 to +4.0	V
V _{CI}	Input Voltage	V _{SS} -0.3 to +5.0	V
I	Current Drain Per Pin Excluding V _{CORE} and V _{SS}	25	mA
T _A	Operating Temperature	-40 to +85	°C
T _{STG}	Storage Temperature	-65 to +150	°C

Table 10-1: Maximum Ratings (Voltage Referenced to V_{SS})

Maximum ratings are those values beyond which damages to the device may occur. Functional operation should be restricted to the limits in the Electrical Characteristics tables or Pin Description section

This device contains circuitry to protect the inputs against damage due to high static voltages or electric fields; however, it is advised that normal precautions be taken to avoid application of any voltage higher than maximum rated voltages to this high impedance circuit. For proper operation it is recommended that V_{CI} and V_{OUT} be constrained to the range V_{SS} < V_{DDIO} ≤ V_{CI} < V_{OUT}. Reliability of operation is enhanced if unused input is connected to an appropriate logic voltage level (e.g., either V_{SS} or V_{DDIO}). Unused outputs must be left open. This device may be light sensitive. Caution should be taken to avoid exposure of this device to any light source during normal operation. This device is not radiation protected.

11 DC CHARACTERISTICS

DC Characteristics (Unless otherwise specified, Voltage Referenced to V_{SS}, T_A = -40 to 85°C)

Symbol	Parameter	Conditions	Min	Typ	Max	Unit
V _{DDIO}	Power supply pin of I/O pins	Recommend Operating Voltage Possible Operating Voltage	1.65	-	3.3	V
V _{CI}	Booster Reference Supply Voltage Range (3)	Recommend Operating Voltage Possible Operating Voltage	2.5 or V _{DDIO}	-	3.3	V
I _{sleep,1}	Sleep mode current (V _{CI} pin)	VDDIO=1.8V, VCI=3.3V	-	10	50	uA
I _{sleep,2}	Sleep mode current (V _{DDIO} pin)		-	1	10	uA
I _{dp}	Operating mode current	VDDIO=1.8V, VCI=3.3V I _{DP} = I _{VDDIO} + I _{VCI}	-	13	18	mA
V _{OUT}	V _{OUT} booster efficiency	See Note1	70	85	-	%
V _{OH1}	Logic High Output Voltage	I _{out} =-100uA	0.8 * V _{DDIO}	-	V _{DDIO}	V
V _{OL1}	Logic Low Output Voltage	I _{out} =100uA	0	-	0.2 * V _{DDIO}	V
V _{IH1}	Logic High Input voltage		0.8 * V _{DDIO}	-	V _{DDIO}	V
V _{IL1}	Logic Low Input voltage		0	-	0.2 * V _{DDIO}	V
I _{OH}	Logic High Output Current Source	V _{OH} = V _{DDIO} -0.4V	50	-	-	μA
I _{OL}	Logic Low Output Current Drain	V _{OL} = 0.4V	-	-	-50	μA
I _{OZ}	Logic Output Tri-state Current Drain Source		-1	-	1	μA
I _{IL} /I _{IH}	Logic Input Current		-1	-	1	μA

Table 11-1: DC Characteristics

12 AC CHARACTERISTICS

Conditions:

$$V_{CI} - V_{SS} = 2.5 \text{ to } 3.3\text{V}$$

$$V_{DDIO} = 1.65\text{-}3.33\text{V}$$

$$T_A = 25^\circ\text{C}$$

Symbol	Parameter	Min	Typ	Max	Unit
t_{cycle}	Clock Cycle Time	2.5	-	-	us
t_{HSTART}	Start condition Hold Time	0.6	-	-	us
t_{HD}	Data Hold Time (for "SDA" pin)	0	-	-	ns
t_{SD}	Data Setup Time	100	-	-	ns
t_{SSTART}	Start condition Setup Time (Only relevant for a repeated Start condition)	0.6	-	-	us
t_{SSTOP}	Stop condition Setup Time	0.6	-	-	us
t_{R}	Rise Time for data and clock pin	-	-	300	ns
t_{F}	Fall Time for data and clock pin	-	-	300	ns
t_{IDLE}	Idle Time before a new transmission can start	1.3	-	-	us

Table 12-1 :I²C Interface Timing Characteristics

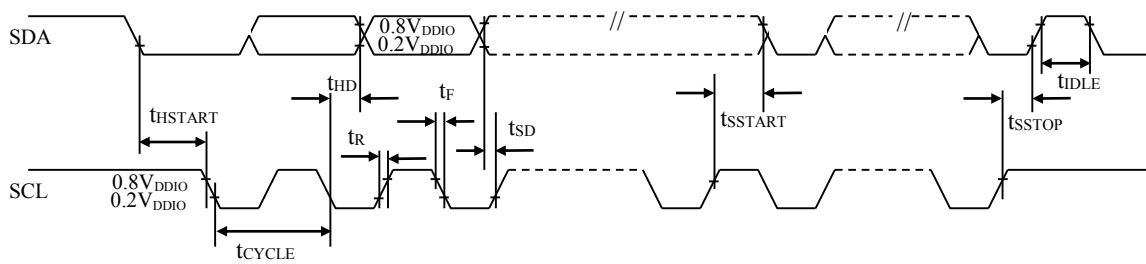
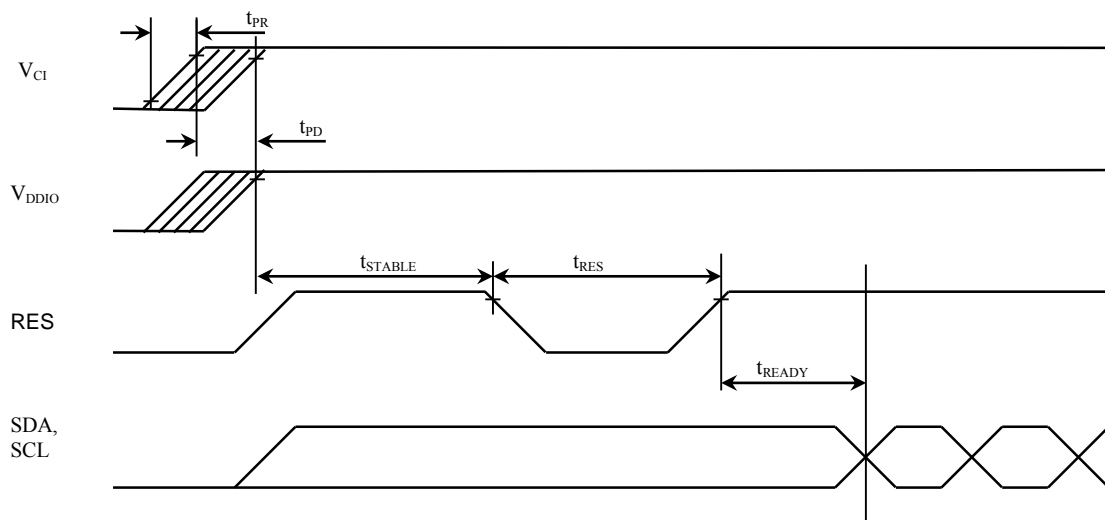

Figure 12-1: I²C Interface Timing Characteristics

13 Power up/down Sequence

13.1 Power up

Symbol	Parameter	Min	Typ	Max	Unit
t_{PR}	Power rise time	-	-	30	us
t_{PD}	Power delay time	-	-	30	us
t_{STABLE}	Chip stable time	10	-	-	us
t_{RES}	Reset pulse	4	-	-	us
t_{READY}	Chip need time after hardware reset	10	-	-	us



13.2 Power down

Symbol	Parameter	Min	Typ	Max	Unit
$t_{DISCHARGE}$	V_{OUT} discharge wait time	50	-	-	ms
t_{PDOWN}	Power Hold time	50	-	-	ms

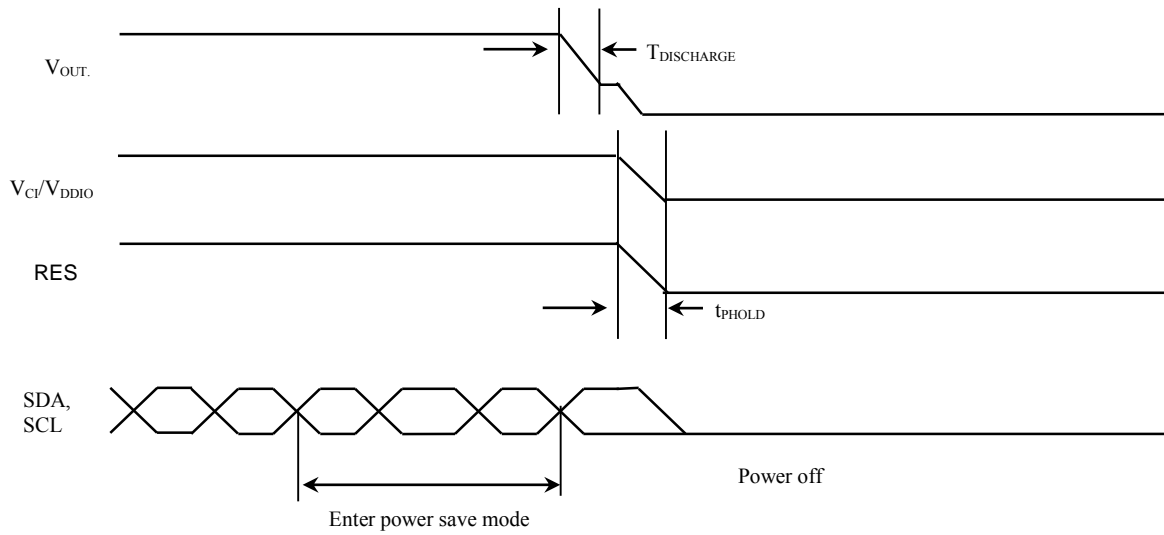

- With regards to the Power Off, V_{out} should be discharged at least below than 5V before turn off the V_{CI}/V_{DDIO} power supplies

14 APPLICATION EXAMPLES

14.1 Application Diagram

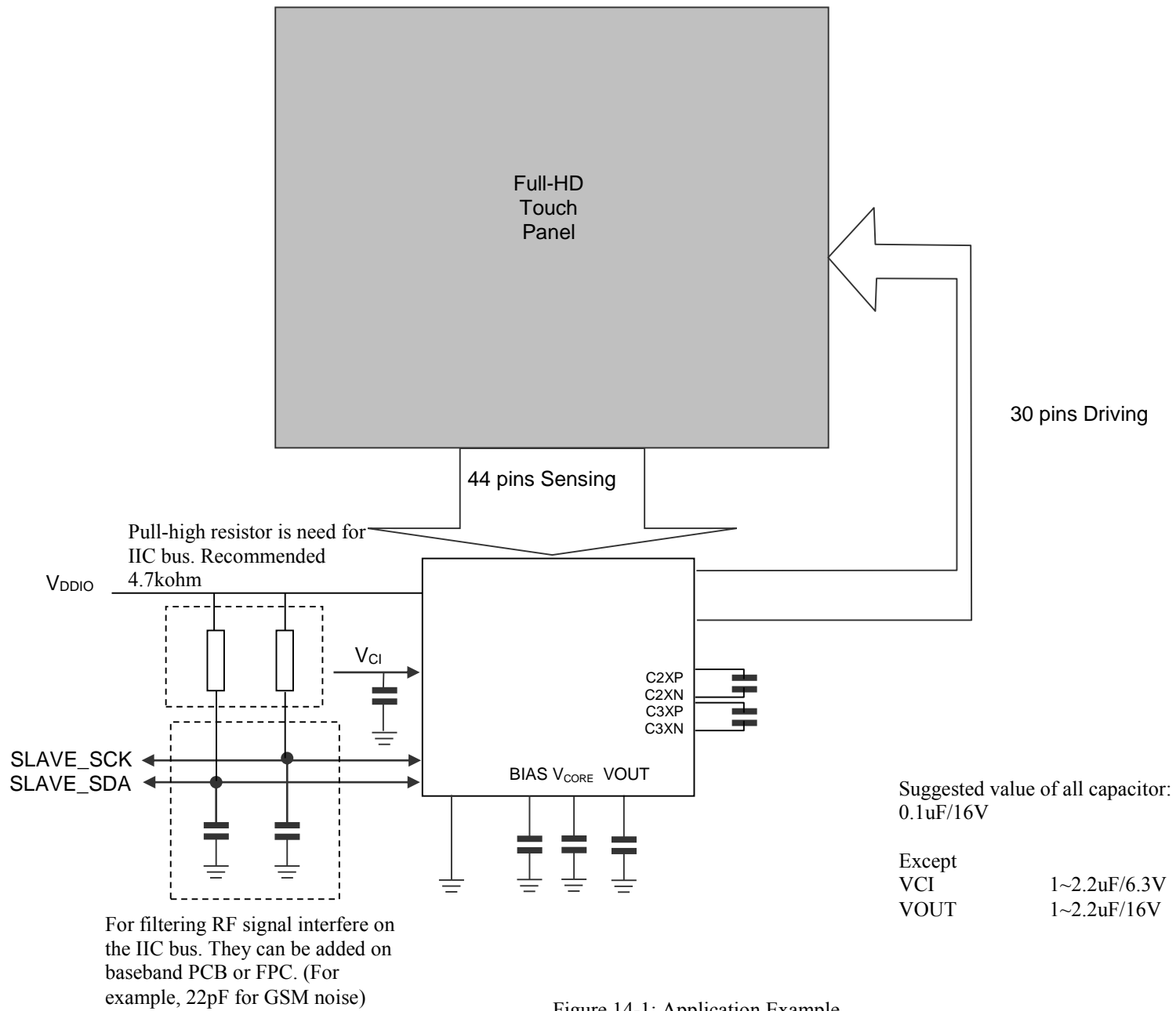
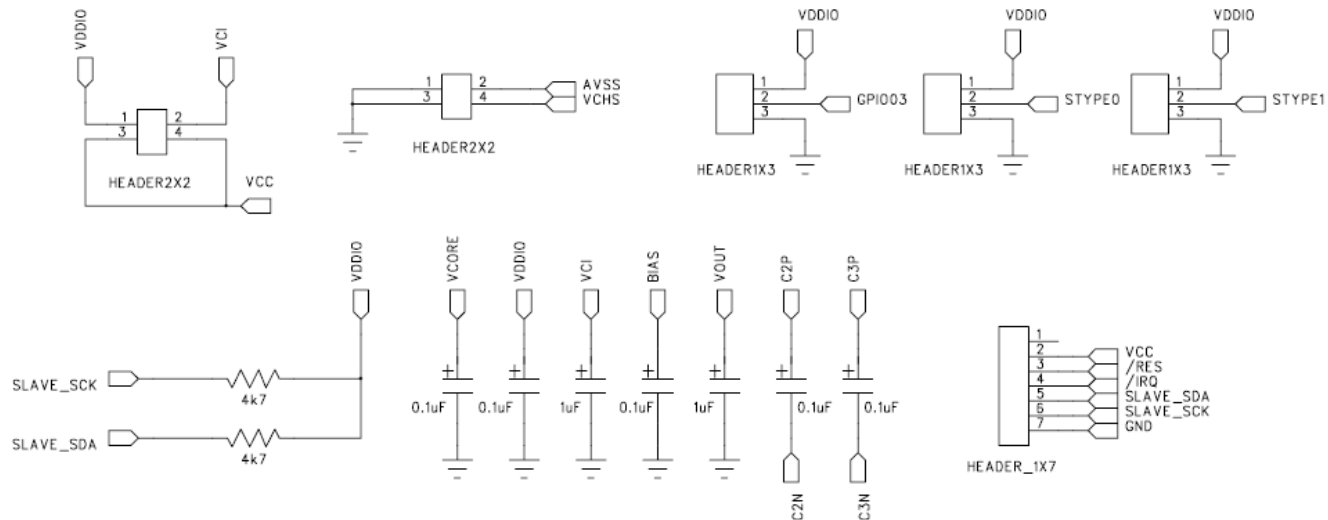
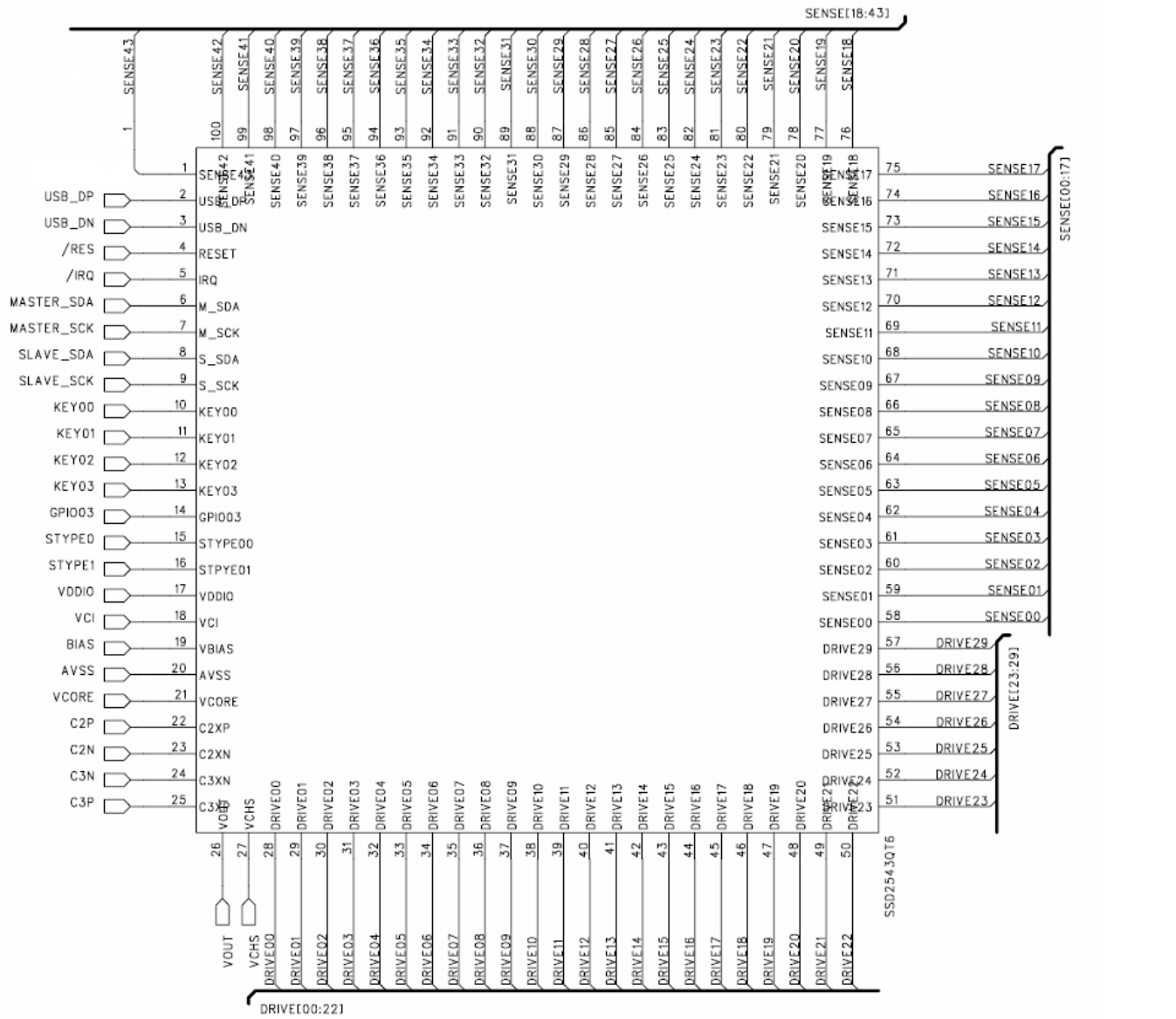

Figure 14-1: Application Example

14.2 FPC Layout Example for QFP100



15 PACKAGE INFORMATION

15.1 TQFP 100 pins (12x12mm)

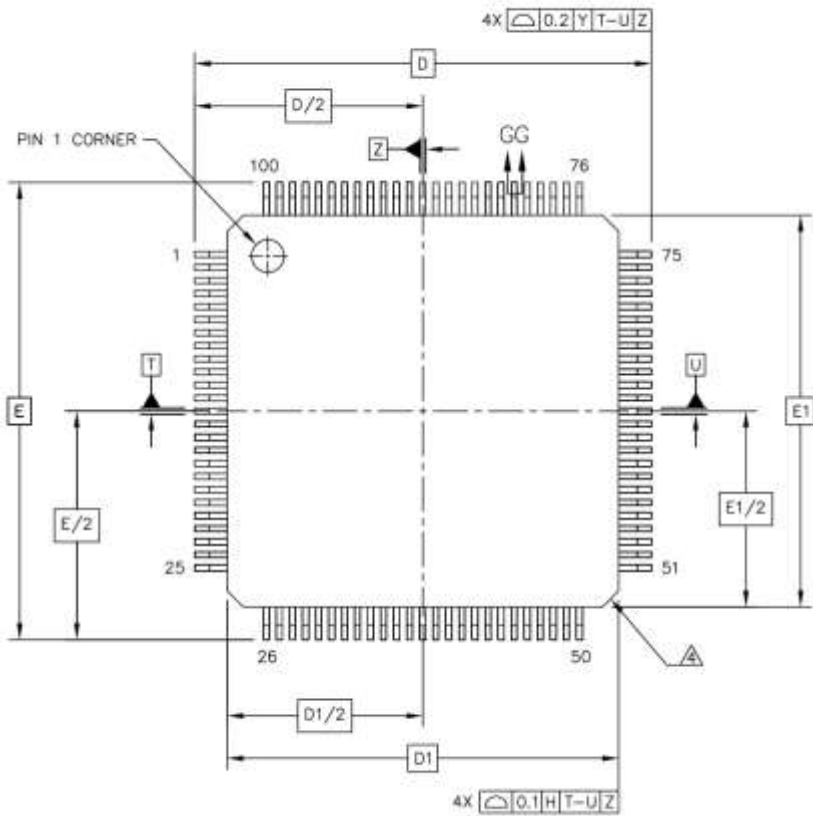
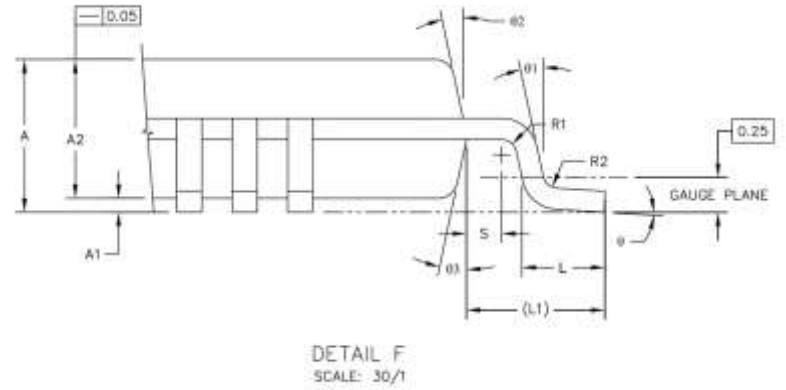
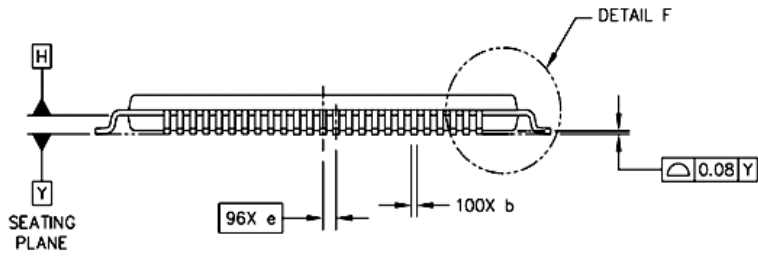

DIM	MIN	MAX	DIM	MIN	MAX
A	---	1.2	L1	1 REF	
A1	0.05	0.15	R1	0.08	---
A2	0.95	1	R2	0.08	0.2
b	0.13	0.18	S	0.2	---
b1	0.13	0.16	θ	0°	3.5° 7°
c	0.09	0.2	$\theta 1$	0°	---
c1	0.09	0.16	$\theta 2$	11°	12° 13°
D	14 BSC		$\theta 3$	11°	12° 13°
D1	12 BSC				
e	0.4 BSC				
E	14 BSC				
E1	12 BSC				
L	0.45	0.6			0.75

15.2 QFN 88 pins (10 x 10 mm)

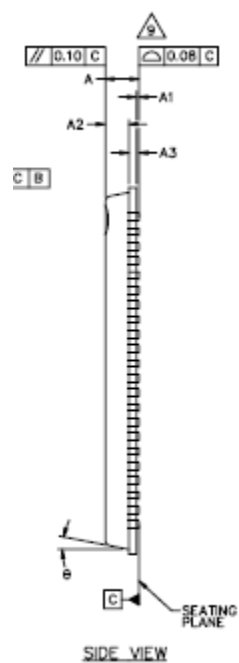
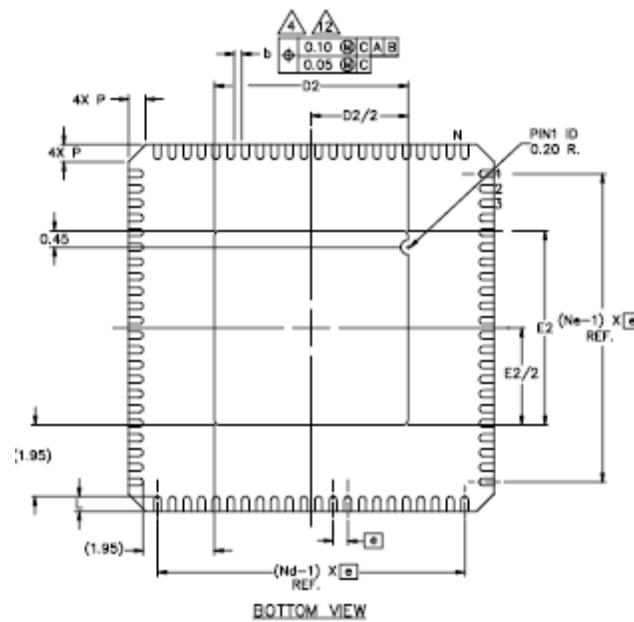
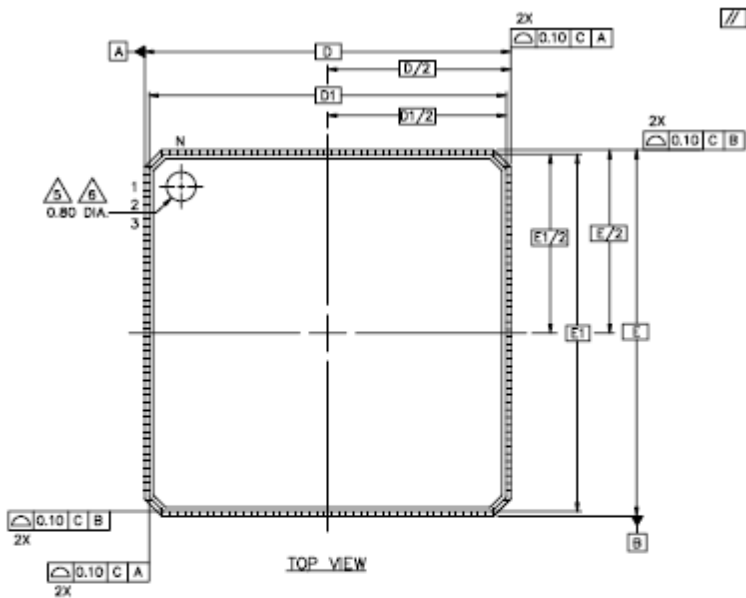

SYMBOL	COMMON DIMENSIONS			NOTE
	MIN.	NOM.	MAX.	
A	0.80	0.85	0.90	
A1	0.00	0.01	0.05	10
A2	0.60	0.65	0.70	
A3	0.20 REF.			
D	10.00 BSC			
D1	9.75 BSC			
E	10.00 BSC			
E1	9.75 BSC			
D2	5.20	5.30	5.40	
E2	5.20	5.30	5.40	
\square	0.40 BSC			
N	88			3
Nd	22			3
Ne	22			3
L	0.30	0.40	0.50	
b	0.15	0.20	0.25	4
θ	0	-	12°	
P	0.24	0.42	0.60	

15.3 QFN 68 pins (8 x 8 mm)

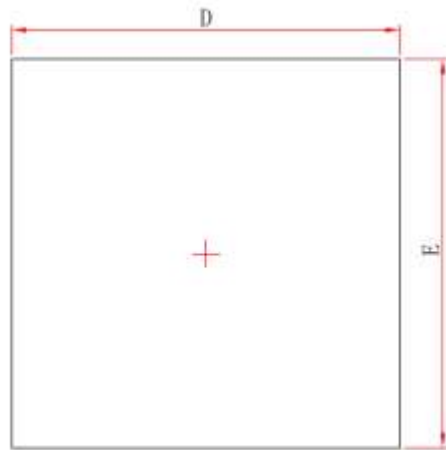

Top View

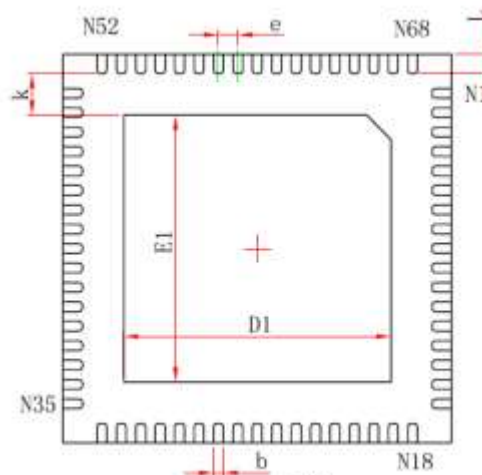

Bottom View



Side View

Symbol	Dimensions In Millimeters		Dimensions In Inches	
	Min.	Max.	Min.	Max.
A	0.700/0.800	0.800/0.900	0.028/0.031	0.031/0.035
A1	0.000	0.050	0.000	0.002
A3	0.203REF.		0.008REF.	
D	7.924	8.076	0.312	0.318
E	7.924	8.076	0.312	0.318
D1	5.400	5.600	0.213	0.220
E1	5.400	5.600	0.213	0.220
k	0.200MIN.		0.008MIN.	
b	0.150	0.250	0.006	0.010
e	0.400TYP.		0.016TYP.	
L	0.324	0.476	0.013	0.019

15.4 Package orientation

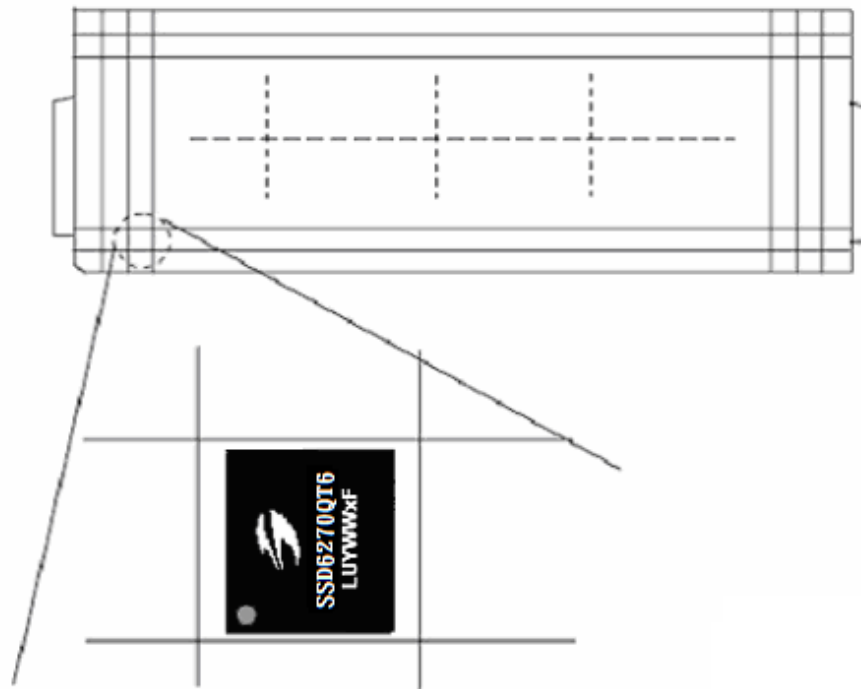

Figure 15-1 : SSD6270QT6 package orientation

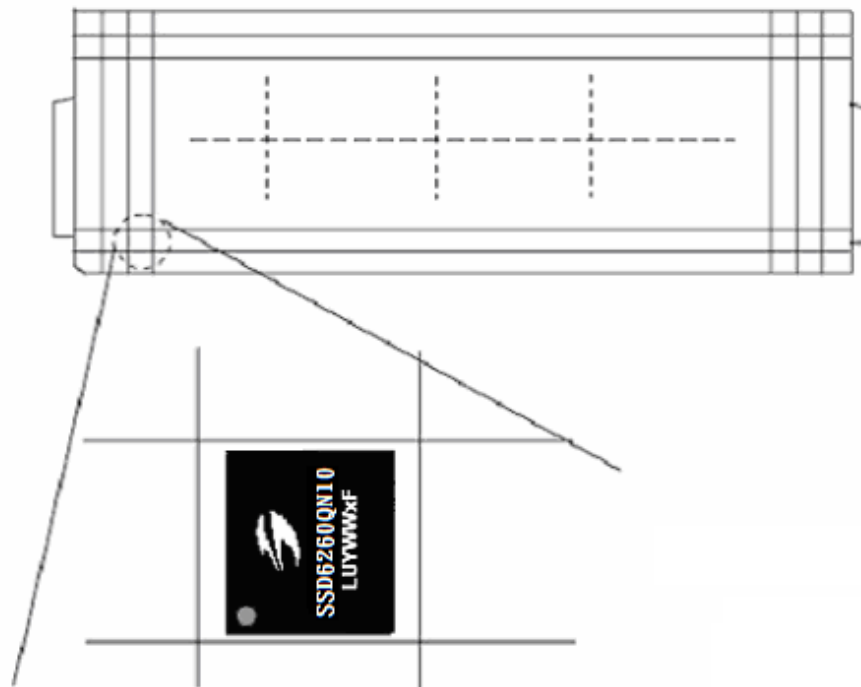

Figure 15-2 : SSD6260QN10 package orientation

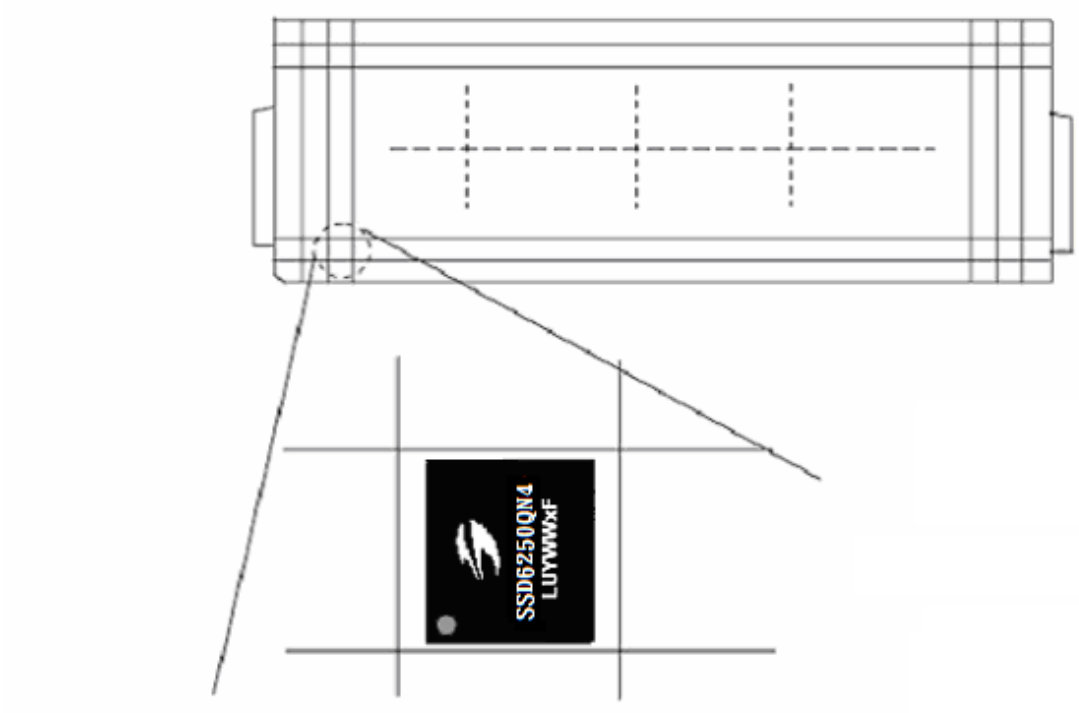

Figure 15-3 : SSD6250QN4/SSD6240QN4 package orientation

Solomon Systech reserves the right to make changes without notice to any products herein. Solomon Systech makes no warranty, representation or guarantee regarding the suitability of its products for any particular purpose, nor does Solomon Systech assume any liability arising out of the application or use of any product or circuit, and specifically disclaims any, and all, liability, including without limitation consequential or incidental damages. "Typical" parameters can and do vary in different applications. All operating parameters, including "Typical" must be validated for each customer application by the customer's technical experts. Solomon Systech does not convey any license under its patent rights nor the rights of others. Solomon Systech products are not designed, intended, or authorized for use as components in systems intended for surgical implant into the body, or other applications intended to support or sustain life, or for any other application in which the failure of the Solomon Systech product could create a situation where personal injury or death may occur. Should Buyer purchase or use Solomon Systech products for any such unintended or unauthorized application, Buyer shall indemnify and hold Solomon Systech and its offices, employees, subsidiaries, affiliates, and distributors harmless against all claims, costs, damages, and expenses, and reasonable attorney fees arising out of, directly or indirectly, any claim of personal injury or death associated with such unintended or unauthorized use, even if such claim alleges that Solomon Systech was negligent regarding the design or manufacture of the part.



The product(s) listed in this datasheet comply with Directive 2011/65/EU of the European Parliament and of the council of 8 June 2011 on the restriction of the use of certain hazardous substances in electrical and electronic equipment and People's Republic of China Electronic Industry Standard SJ/T 11363-2006 "Requirements for concentration limits for certain hazardous substances in electronic information products (电子信息产品中有毒有害物质的限量要求)". Hazardous Substances test report is available upon request.

<http://www.solomon-systech.com>