

Dual Enhancement Mode MOSFET (N-and P-Channel)

Features

- **N Channel**
30V/8.7A,
 $R_{DS(ON)} = 21m\Omega$ (max.) @ $V_{GS} = 10V$
 $R_{DS(ON)} = 30m\Omega$ (max.) @ $V_{GS} = 4.5V$
- **P Channel**
-30V/-8.2A,
 $R_{DS(ON)} = 24m\Omega$ (max.) @ $V_{GS} = -10V$
 $R_{DS(ON)} = 38m\Omega$ (max.) @ $V_{GS} = -4.5V$
- 100% UIS Tested
- Reliable and Rugged
- Lead Free Available (RoHS Compliant)

Applications

- Synchronous Rectification.
- Motor Control
- High Current, High Speed Switching

Pin Description

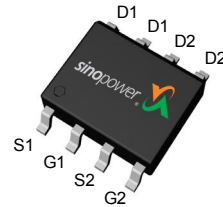

Top View of SOP – 8

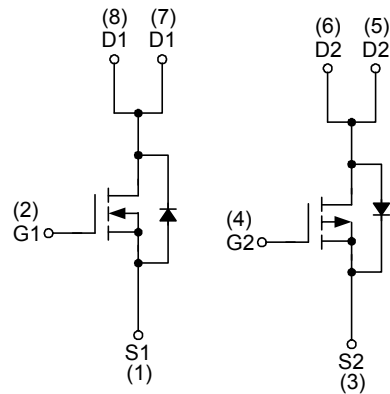

N-Channel MOSFET

P-Channel MOSFET

Ordering and Marking Information

<p>SM4603CS □□-□□□</p> <div style="margin-left: 20px;"> <p>└─ Assembly Material</p> <p>└─ Handling Code</p> <p>└─ Temperature Range</p> <p>└─ Package Code</p> </div>	<p>Package Code K : SOP-8</p> <p>Operating Junction Temperature Range C : -55 to 175 °C</p> <p>Handling Code TR : Tape & Reel (2500ea/reel)</p> <p>Assembly Material G : Halogen and Lead Free Device</p>
<p>SM4603CS K : </p>	<p>XXXXX - Date Code</p>

Note : SINOPOWER lead-free products contain molding compounds/die attach materials and 100% matte tin plate termination finish; which are fully compliant with RoHS. SINOPOWER lead-free products meet or exceed the lead-free requirements of IPC/JEDEC J-STD-020D for MSL classification at lead-free peak reflow temperature. SINOPOWER defines “Green” to mean lead-free (RoHS compliant) and halogen free (Br or Cl does not exceed 900ppm by weight in homogeneous material and total of Br and Cl does not exceed 1500ppm by weight).

SINOPOWER reserves the right to make changes to improve reliability or manufacturability without notice, and advise customers to obtain the latest version of relevant information to verify before placing orders.

Absolute Maximum Ratings ($T_A = 25^\circ\text{C}$ unless otherwise noted)

Symbol	Parameter	N Channel	P Channel	Unit	
Common Ratings					
V_{DSS}	Drain-Source Voltage	30	-30	V	
V_{GSS}	Gate-Source Voltage	± 20	± 20	V	
T_J	Maximum Junction Temperature	175		$^\circ\text{C}$	
T_{STG}	Storage Temperature Range	-55 to 175		$^\circ\text{C}$	
I_S	Diode Continuous Forward Current	2	-2	A	
I_{DP}	300 μs Pulse Drain Current Tested	$V_{GS}=10\text{V(N)}, V_{GS}=-10\text{V(P)}$		A	
I_D	Continuous Drain Current	$T_A=25^\circ\text{C}$	8.7	-8.2	A
		$T_A=70^\circ\text{C}$	7.3	-6.8	
P_D	Maximum Power Dissipation	$T_A=25^\circ\text{C}$	2.4	2.4	W
		$T_A=70^\circ\text{C}$	1.7	1.7	
$R_{\theta JL}$	Thermal Resistance-Junction to Lead	Steady State	50	50	$^\circ\text{C/W}$
$R_{\theta JA}$	Thermal Resistance-Junction to Ambient	$t \leq 10\text{s}$	62.5	62.5	$^\circ\text{C/W}$
		Steady State	110	110	
I_{AS}^a	Avalanche Current, Single pulse (L=0.5mH)	7.2	12	A	
E_{AS}^a	Avalanche Energy, Single pulse (L=0.5mH)	12	36	mJ	

Note a : UIS tested and pulse width limited by maximum junction temperature 150°C (initial temperature $T_J=25^\circ\text{C}$).

N Channel Electrical Characteristics ($T_A = 25^\circ\text{C}$ unless otherwise noted)

Symbol	Parameter	Test Conditions	N Channel			Unit
			Min.	Typ.	Max.	
Static Characteristics						
BV_{DSS}	Drain-Source Breakdown Voltage	$V_{GS}=0V, I_{DS}=250\mu A$	30	-	-	V
I_{DSS}	Zero Gate Voltage Drain Current	$V_{DS}=24V, V_{GS}=0V$ $T_J=85^\circ\text{C}$	-	-	1	μA
			-	-	30	
$V_{GS(th)}$	Gate Threshold Voltage	$V_{DS}=V_{GS}, I_{DS}=250\mu A$	1.5	1.8	2.5	V
I_{GSS}	Gate Leakage Current	$V_{GS}=\pm 20V, V_{DS}=0V$	-	-	± 100	nA
$R_{DS(ON)}^b$	Drain-Source On-state Resistance	$V_{GS}=10V, I_{DS}=8A$	-	17	21	m Ω
		$V_{GS}=4.5V, I_{DS}=5A$	-	23	30	
Diode Characteristics						
V_{SD}^b	Diode Forward Voltage	$I_{SD}=1A, V_{GS}=0V$	-	0.75	1.1	V
t_{rr}	Reverse Recovery Time	$I_{DS}=8A, dI_{SD}/dt=100A/\mu s$	-	12	-	ns
Q_{rr}	Reverse Recovery Charge		-	3.5	-	nC
Dynamic Characteristics^c						
R_G	Gate Resistance	$V_{GS}=0V, V_{DS}=0V, F=1\text{MHz}$	-	1.5	-	Ω
C_{iss}	Input Capacitance	$V_{GS}=0V,$ $V_{DS}=15V,$ Frequency=1.0MHz	-	410	-	pF
C_{oss}	Output Capacitance		-	70	-	
C_{riss}	Reverse Transfer Capacitance		-	40	-	
$t_{d(ON)}$	Turn-on Delay Time		$V_{DD}=15V, R_L=15\Omega,$ $I_{DS}=1A, V_{GEN}=10V,$ $R_G=6\Omega$	-	5.2	-
t_r	Turn-on Rise Time	-		8.6	-	
$t_{d(OFF)}$	Turn-off Delay Time	-		13.5	-	
t_f	Turn-off Fall Time	-		3.4	-	
Gate Charge Characteristics^c						
Q_g	Total Gate Charge	$V_{DS}=15V, V_{GS}=10V,$ $I_{DS}=8A$	-	8.1	13	nC
Q_g	Total Gate Charge		-	3.9	5.5	
Q_{gth}	Threshold Gate Charge	$V_{DS}=15V, V_{GS}=4.5V,$ $I_{DS}=8A$	-	0.73	-	
Q_{gs}	Gate-Source Charge		-	1.5	-	
Q_{gd}	Gate-Drain Charge		-	1.6	-	

Note b : Pulse test ; pulse width $\leq 300\mu s$, duty cycle $\leq 2\%$.

c : Guaranteed by design, not subject to production testing.

P Channel Electrical Characteristics (T_A = 25°C unless otherwise noted)

Symbol	Parameter	Test Conditions	P Channel			Unit
			Min.	Typ.	Max.	
Static Characteristics						
BV _{DSS}	Drain-Source Breakdown Voltage	V _{GS} =0V, I _{DS} =-250μA	-30	-	-	V
I _{DSS}	Zero Gate Voltage Drain Current	V _{DS} =-24V, V _{GS} =0V	-	-	-1	μA
		T _J =85°C	-	-	-30	mA
V _{GS(th)}	Gate Threshold Voltage	V _{DS} =V _{GS} , I _{DS} =-250μA	-1.3	-1.8	-2.3	V
I _{GSS}	Gate Leakage Current	V _{GS} =±20V, V _{DS} =0V	-	-	±100	nA
R _{DS(ON)} ^b	Drain-Source On-state Resistance	V _{GS} =-10V, I _{DS} =-7.5A	-	20	24	mΩ
		V _{GS} =-4.5V, I _{DS} =-4A	-	30	38	
Diode Characteristics						
V _{SD} ^b	Diode Forward Voltage	I _{SD} =-1A, V _{GS} =0V	-	-0.75	-1	V
t _{rr}	Reverse Recovery Time	I _{DS} =-7.5A,	-	18	-	ns
Q _{rr}	Reverse Recovery Charge	dI _{SD} /dt=100A/μs	-	9	-	nC
Dynamic Characteristics^c						
R _G	Gate Resistance	V _{GS} =0V, V _{DS} =0V, F=1MHz	-	7	-	Ω
C _{iss}	Input Capacitance	V _{GS} =0V, V _{DS} =-15V, Frequency=1.0MHz	-	840	-	pF
C _{oss}	Output Capacitance		-	150	-	
C _{rss}	Reverse Transfer Capacitance		-	110	-	
t _{d(ON)}	Turn-on Delay Time	V _{DD} =-15V, R _L =15Ω, I _{DS} =-1A, V _{GEN} =-10V, R _G =6Ω	-	7.5	-	ns
t _r	Turn-on Rise Time		-	8	-	
t _{d(OFF)}	Turn-off Delay Time		-	37	-	
t _f	Turn-off Fall Time		-	16	-	
Gate Charge Characteristics^c						
Q _g	Total Gate Charge	V _{DS} =-15V, V _{GS} =-10V, I _{DS} =-7.5A	-	18	-	nC
Q _g	Total Gate Charge	V _{DS} =-15V, V _{GS} =-4.5V, I _{DS} =-7.5A	-	8.5	-	
Q _{gth}	Threshold Gate Charge		-	1.6	-	
Q _{gs}	Gate-Source Charge		-	3	-	
Q _{gd}	Gate-Drain Charge		-	4	-	

Note b : Pulse test; pulse width ≤ 300μs, duty cycle ≤ 2%.

c : Guaranteed by design, not subject to production testing.

N Channel Typical Operating Characteristics

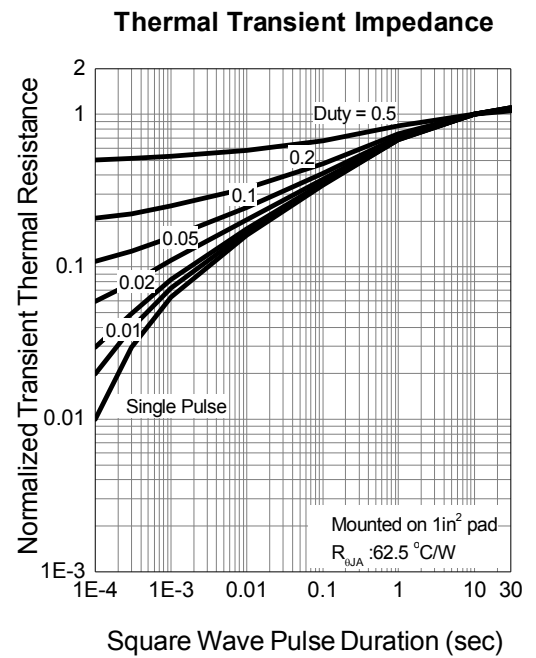
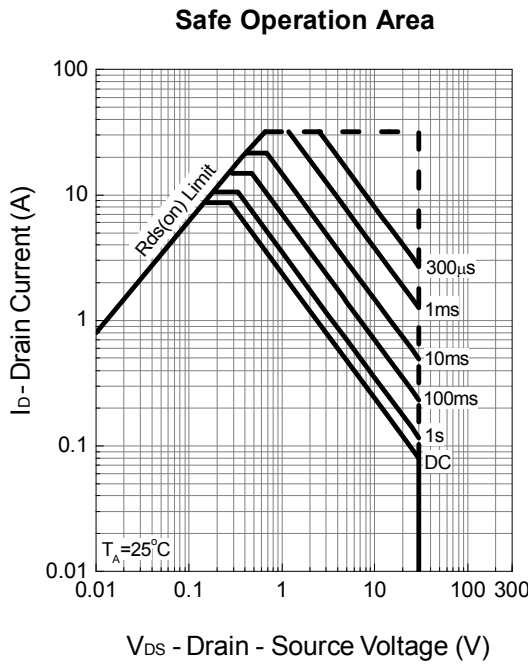
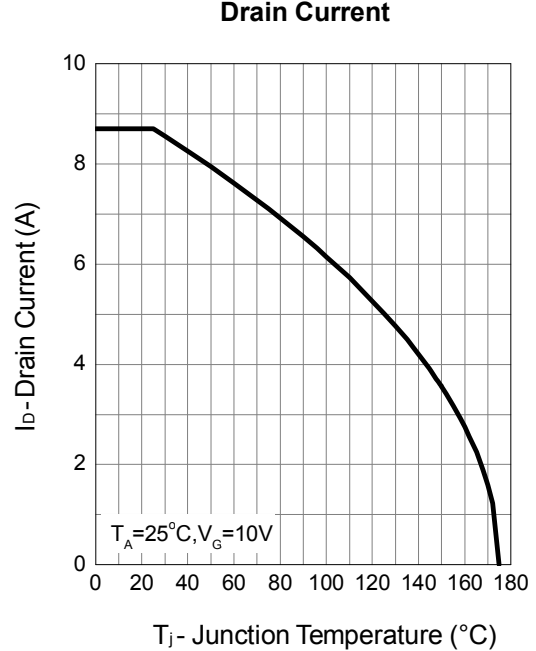
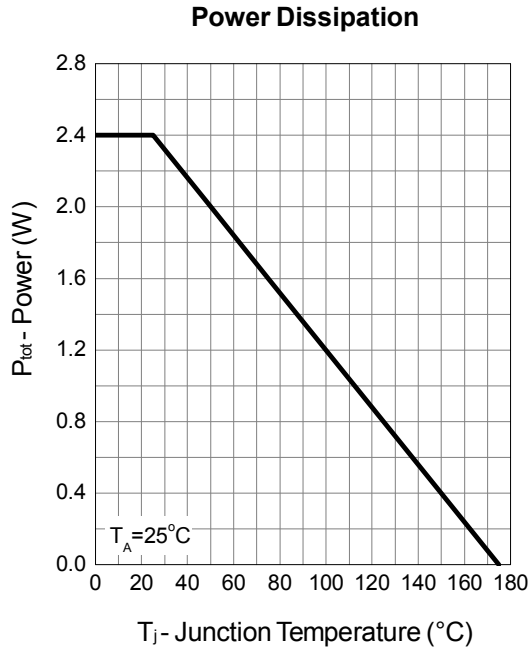

N Channel Typical Operating Characteristics (Cont.)

Output Characteristics

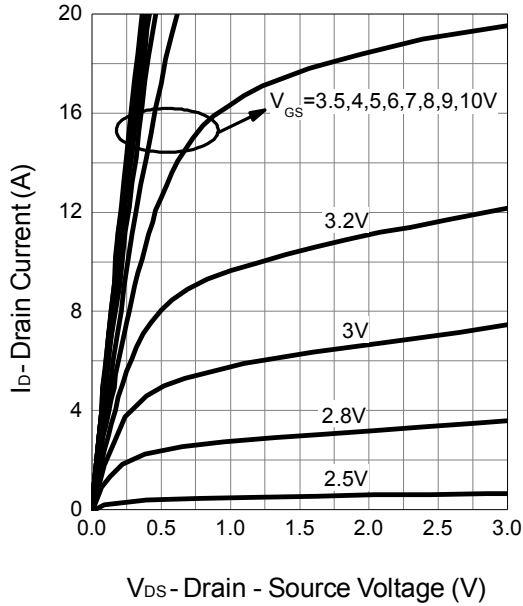

Drain-Source On Resistance

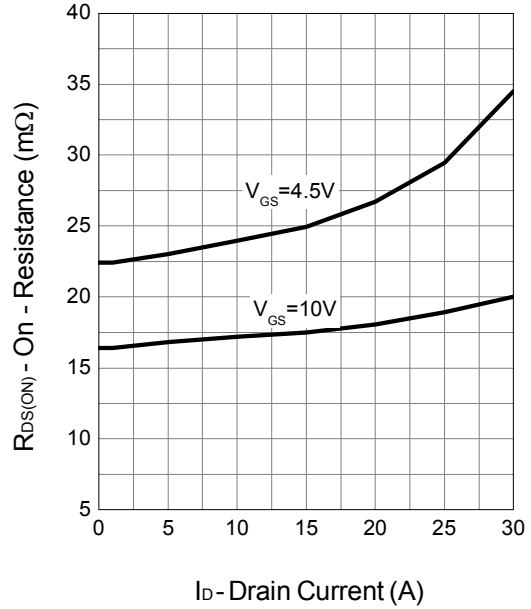

Gate-Source On Resistance

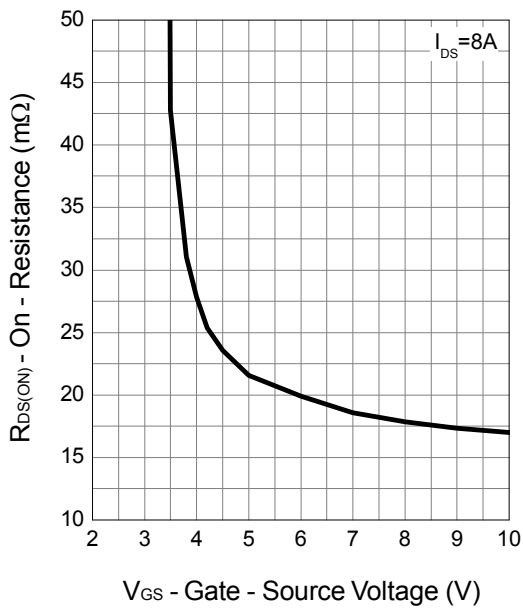

Gate Threshold Voltage

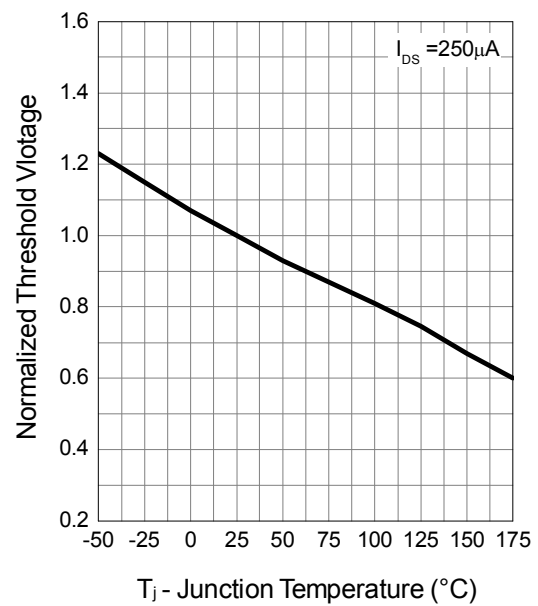

N Channel Typical Operating Characteristics (Cont.)

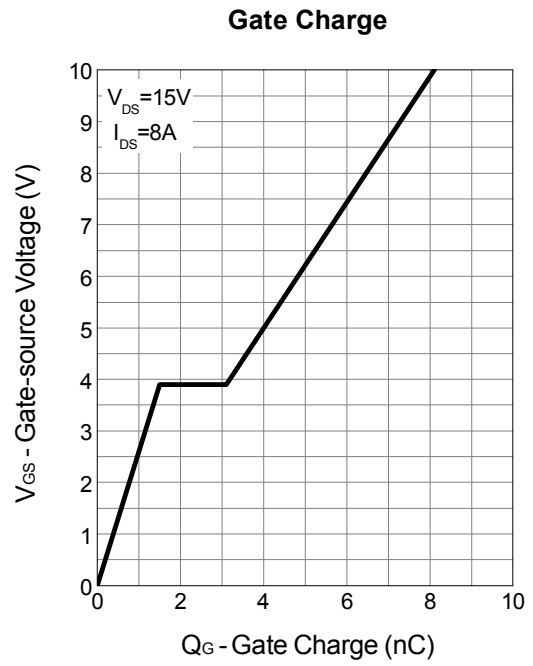
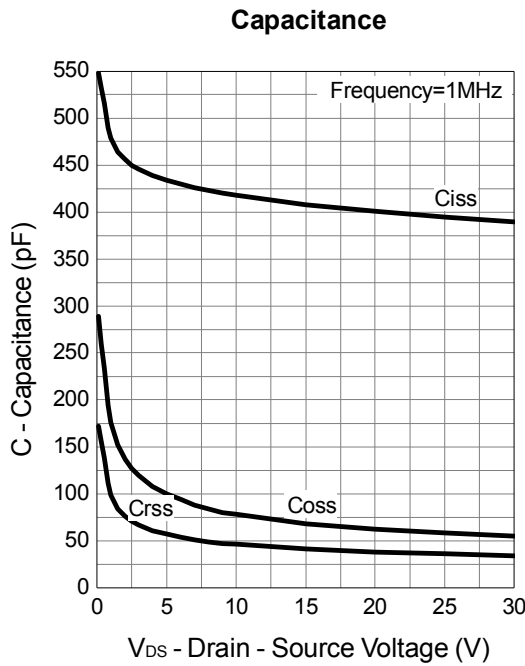
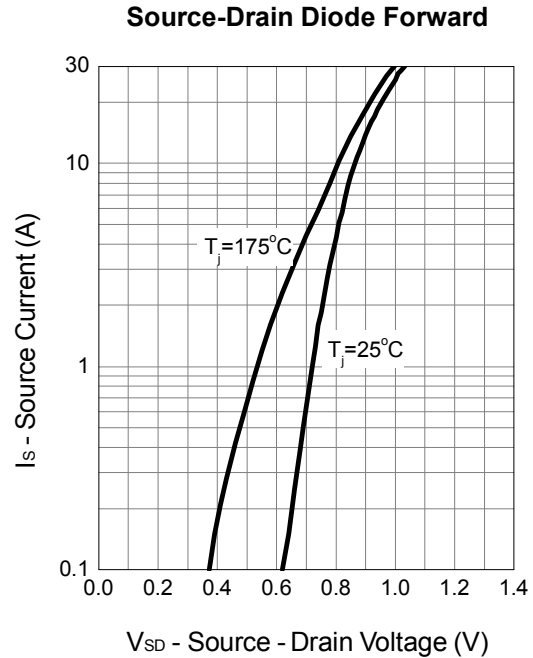
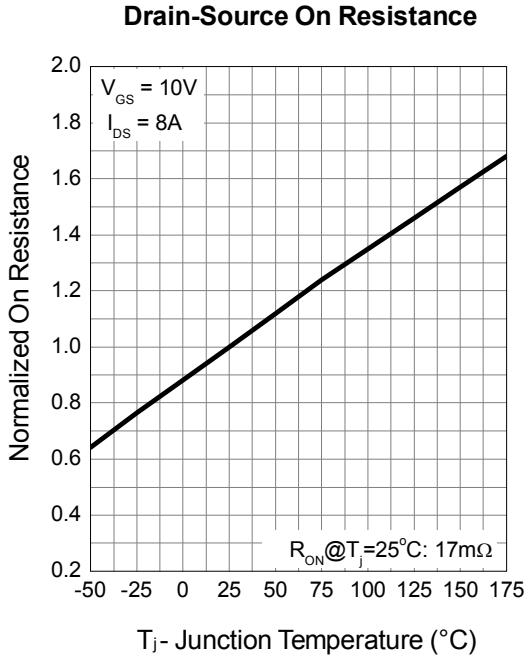

P Channel Typical Operating Characteristics

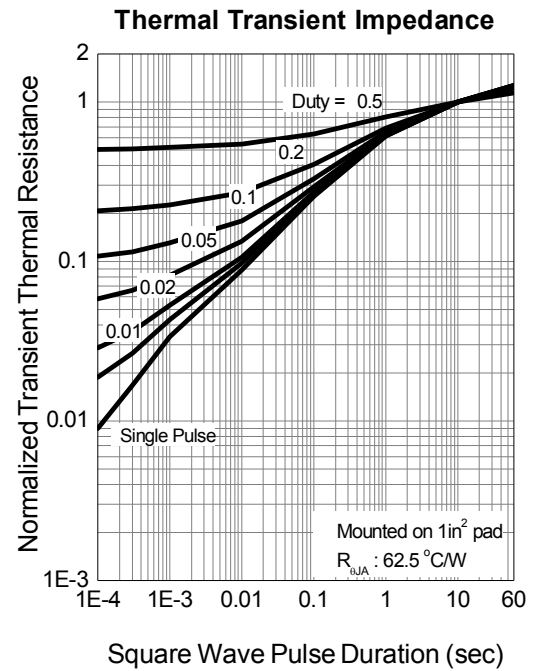
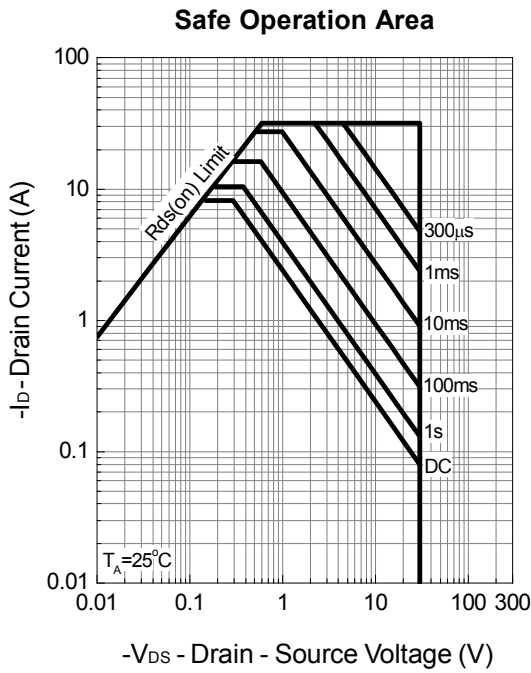
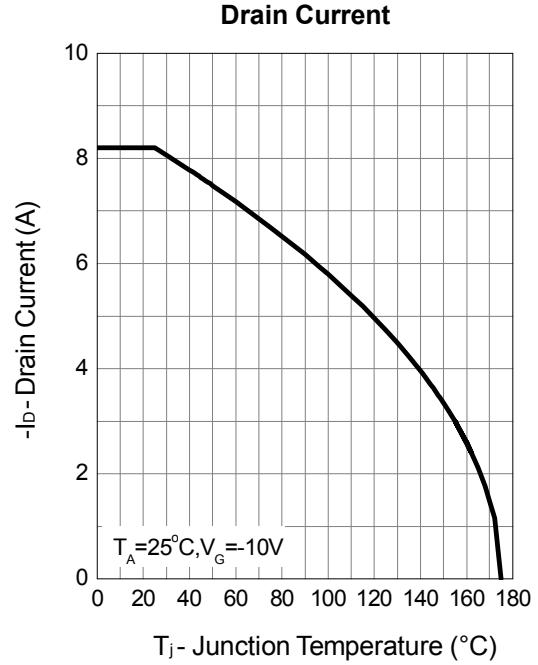
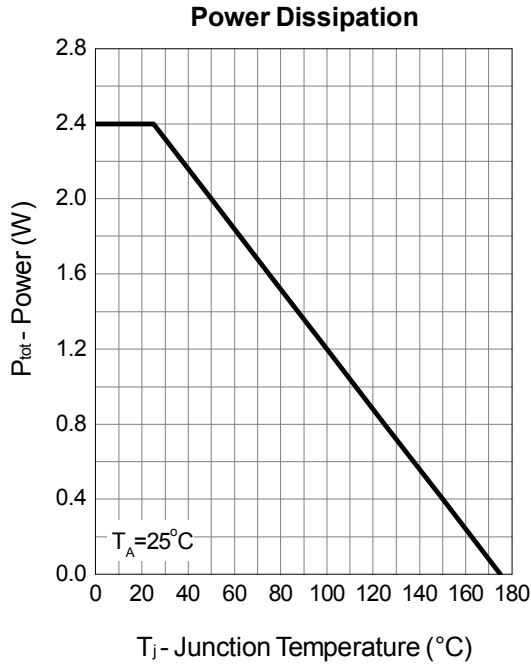

P Channel Typical Operating Characteristics (Cont.)

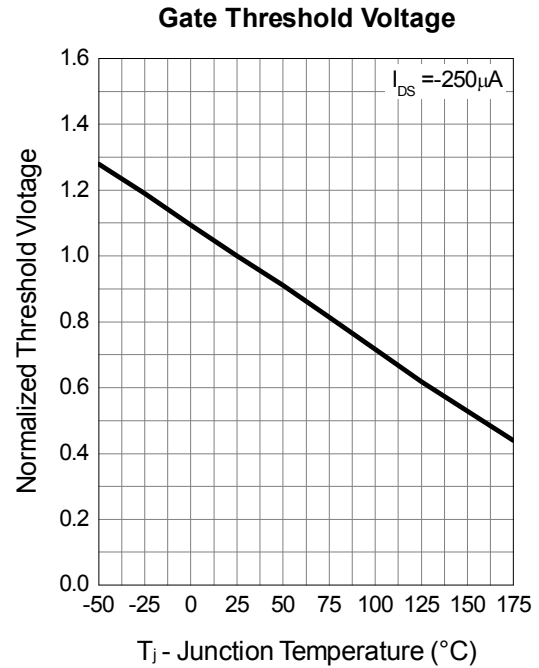
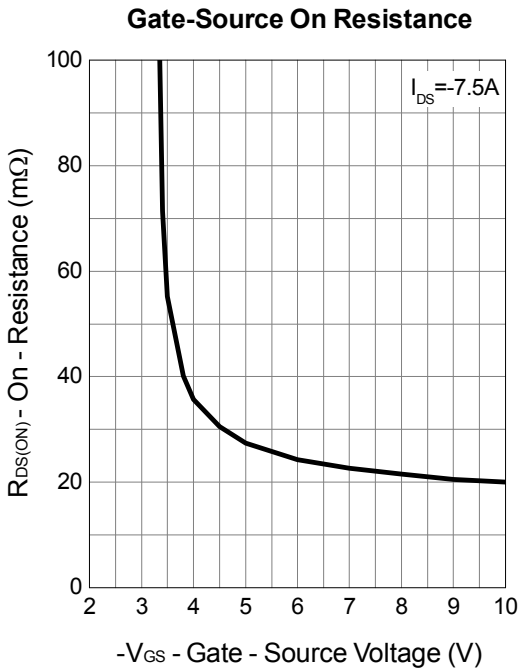
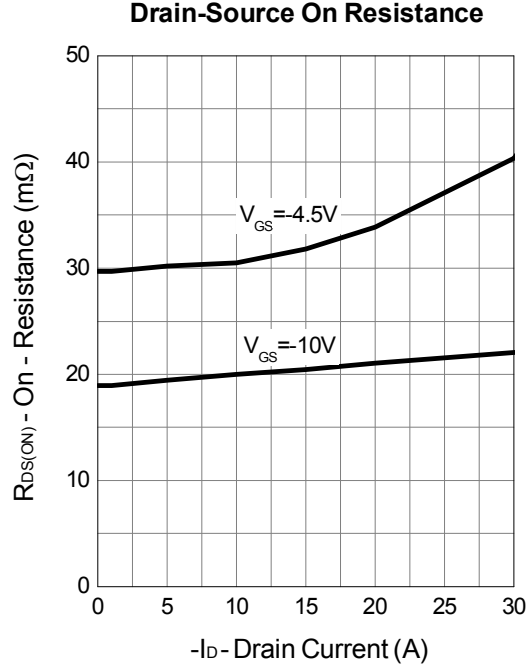
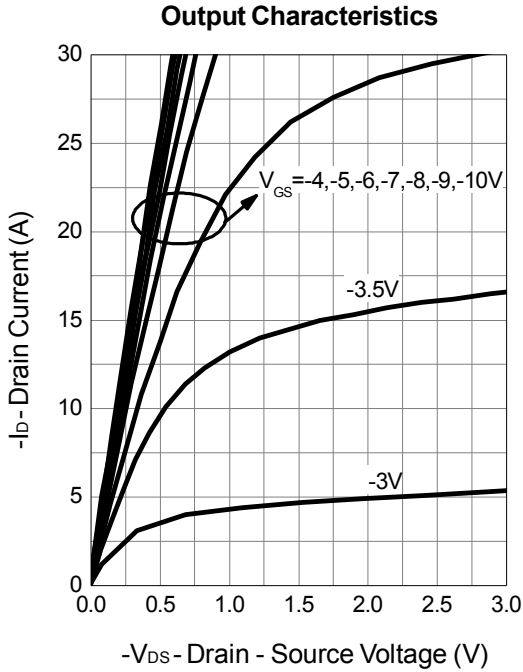

P Channel Typical Operating Characteristics (Cont.)

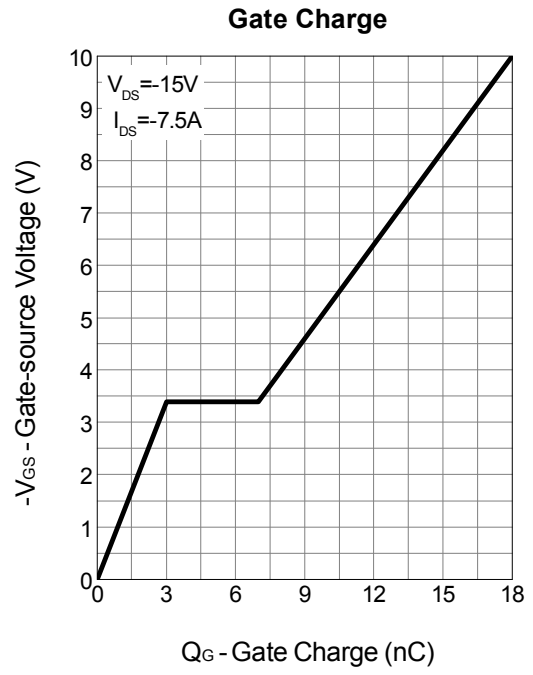
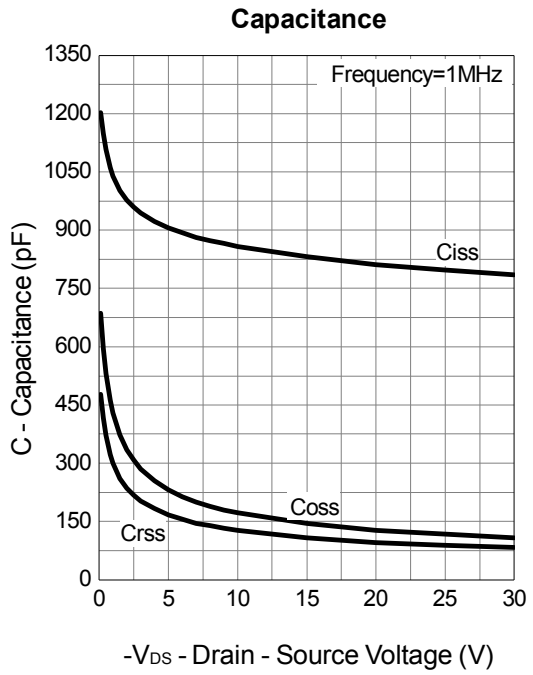
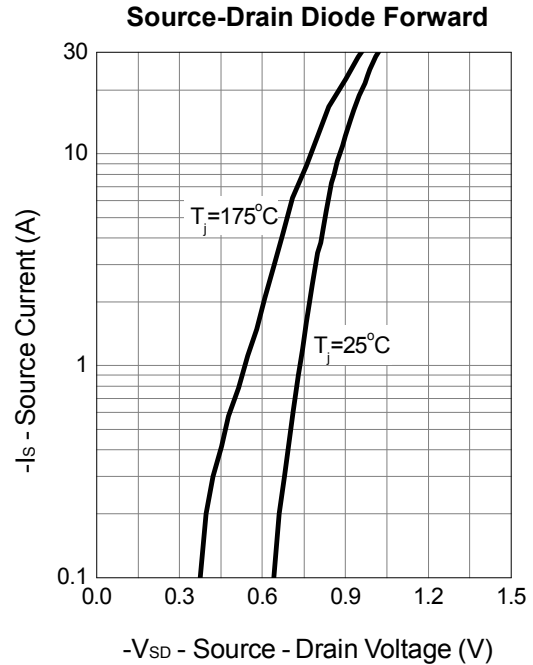
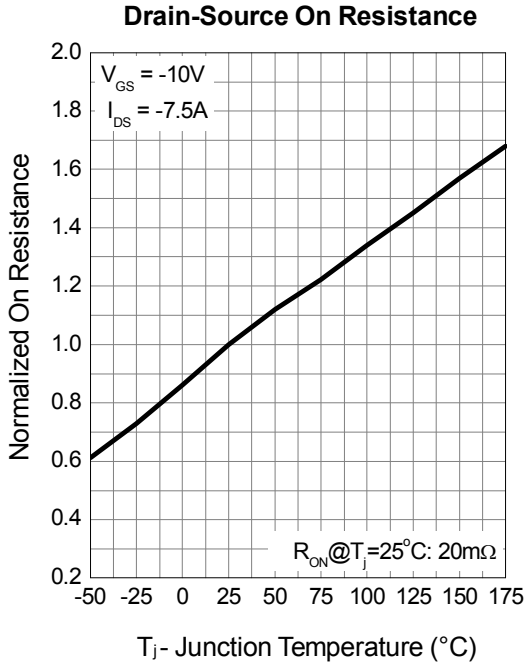

Avalanche Test Circuit and Waveforms

N Channel

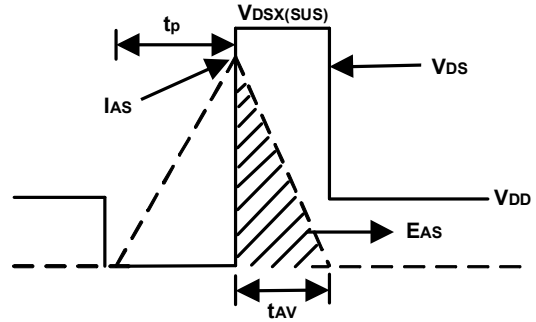
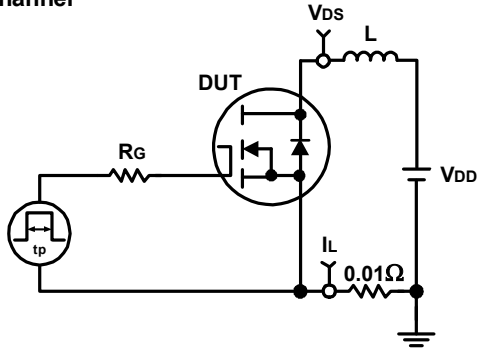

P Channel

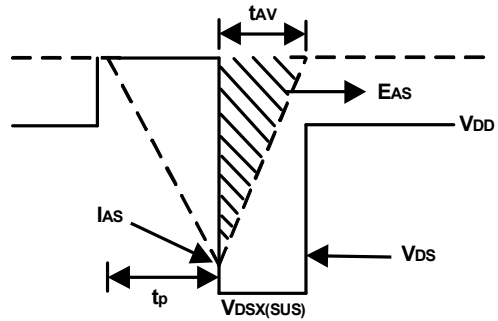
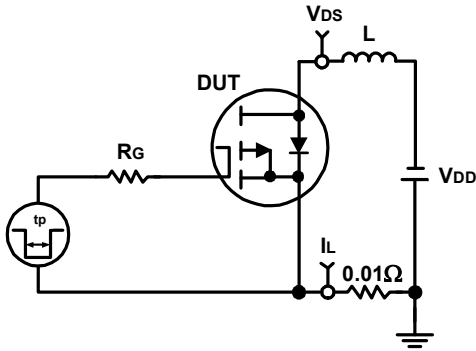

Switching Time Test Circuit and Waveforms

N Channel

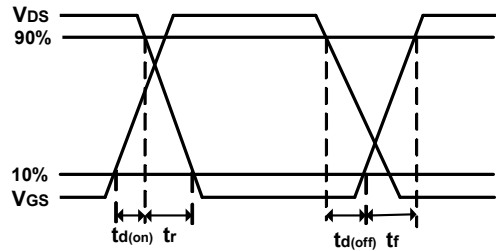
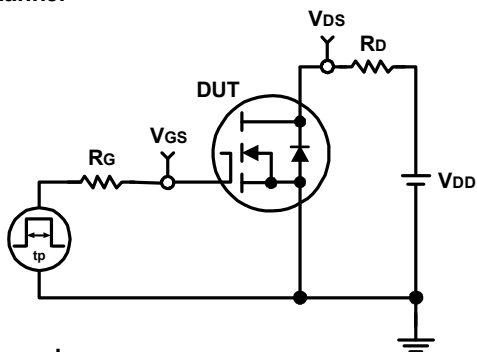

P Channel

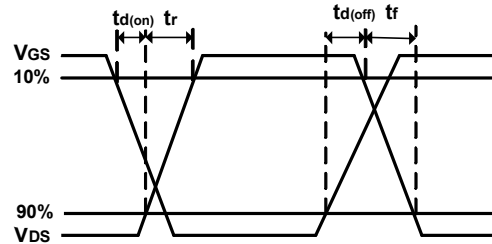
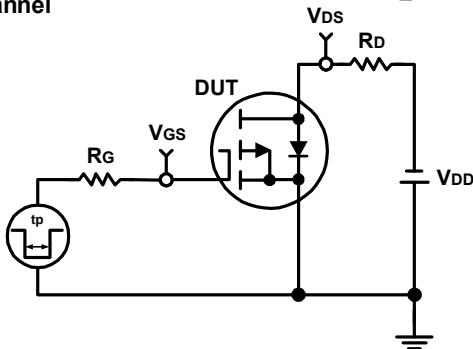

Package Information

SOP-8

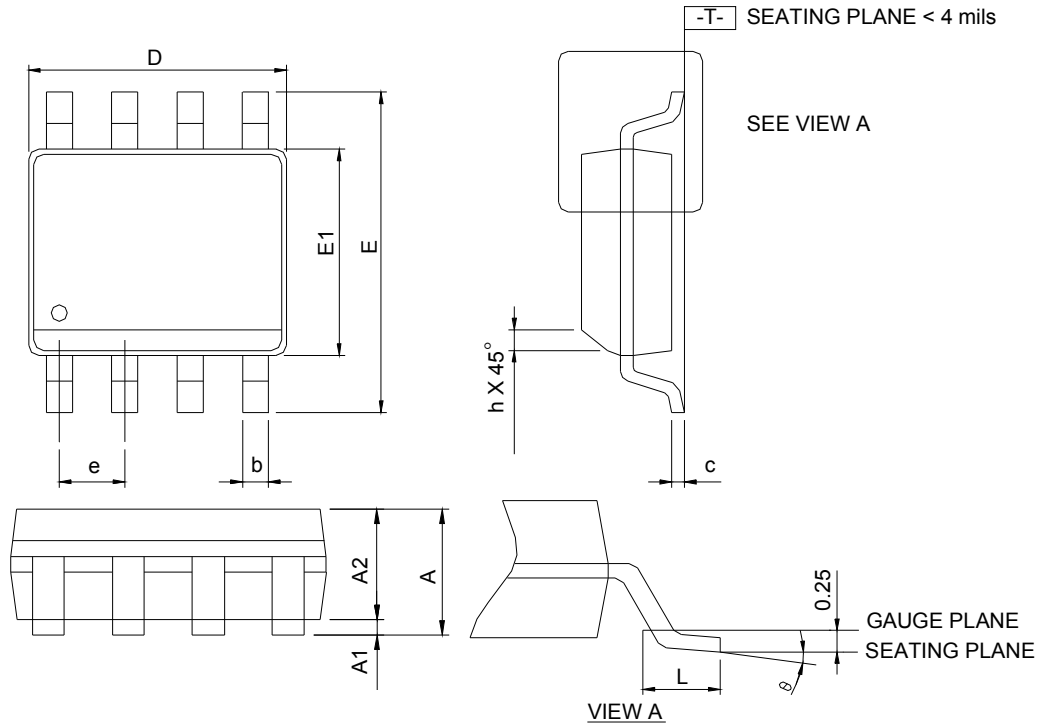

DIMENSIONS	SOP-8			
	MILLIMETERS		INCHES	
	MIN.	MAX.	MIN.	MAX.
A	-	1.75	-	0.069
A1	0.10	0.25	0.004	0.010
A2	1.25	-	0.049	-
b	0.31	0.51	0.012	0.020
c	0.17	0.25	0.007	0.010
D	4.80	5.00	0.189	0.197
E	5.80	6.20	0.228	0.244
E1	3.80	4.00	0.150	0.157
e	1.27 BSC		0.050 BSC	
h	0.25	0.50	0.010	0.020
L	0.40	1.27	0.016	0.050
θ	0°	8°	0°	8°

RECOMMENDED LAND PATTERN

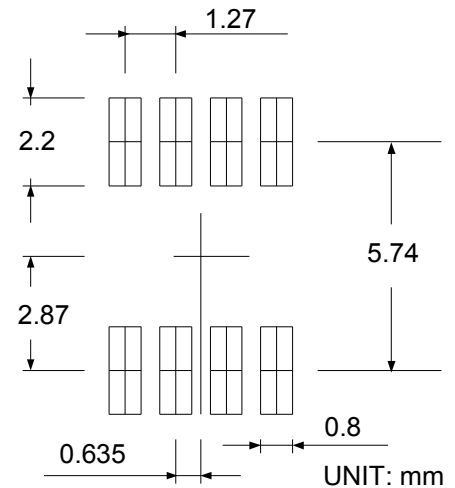

- Note: 1. Follow JEDEC MS-012 AA.
 2. Dimension "D" does not include mold flash, protrusions or gate burrs. Mold flash, protrusion or gate burrs shall not exceed 6 mil per side.
 3. Dimension "E" does not include inter-lead flash or protrusions. Inter-lead flash and protrusions shall not exceed 10 mil per side.

Carrier Tape & Reel Dimensions

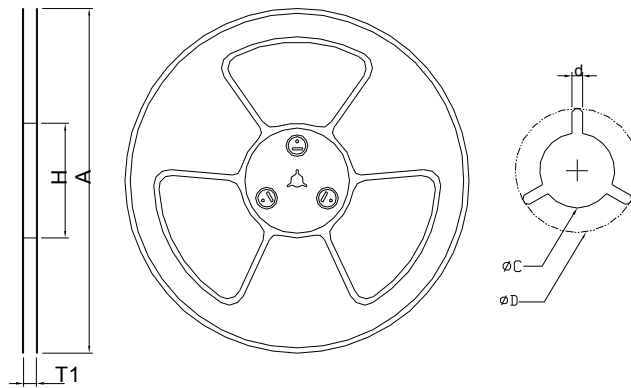
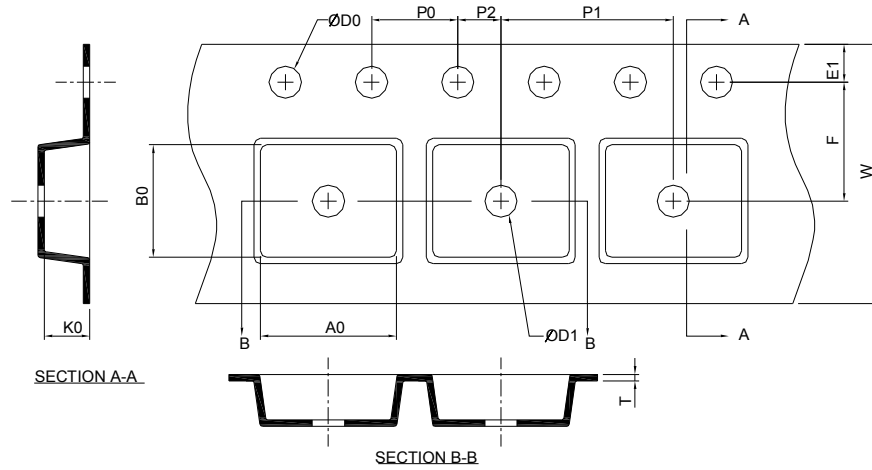

Application	A	H	T1	C	d	D	W	E1	F
SOP-8	330.0 ± 2.00	50 MIN.	$12.4 + 2.00$ -0.00	$13.0 + 0.50$ -0.20	1.5 MIN.	20.2 MIN.	12.0 ± 0.30	1.75 ± 0.10	5.5 ± 0.05
	P0	P1	P2	D0	D1	T	A0	B0	K0
	4.0 ± 0.10	8.0 ± 0.10	2.0 ± 0.05	$1.5 + 0.10$ -0.00	1.5 MIN.	$0.6 + 0.00$ -0.40	6.40 ± 0.20	5.20 ± 0.20	2.10 ± 0.20

(mm)

Taping Direction Information

SOP-8

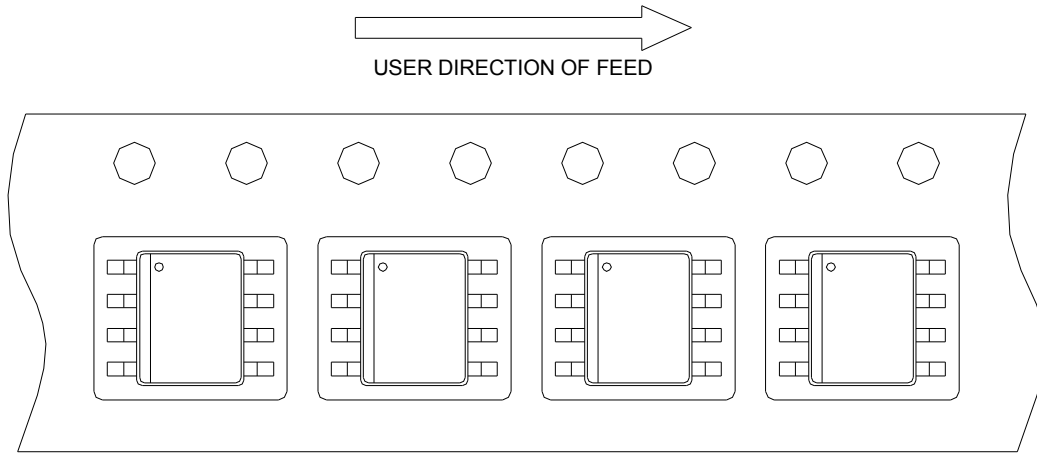

Classification Profile

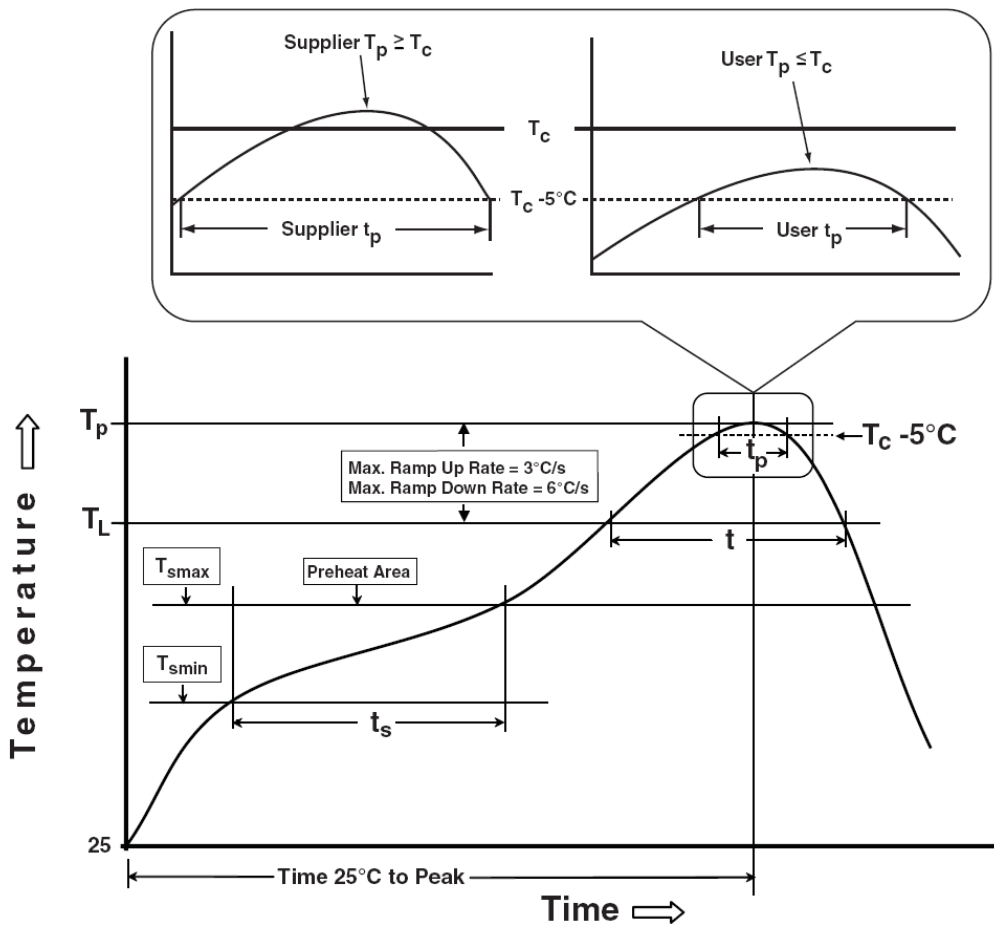

Classification Reflow Profiles

Profile Feature	Sn-Pb Eutectic Assembly	Pb-Free Assembly
Preheat & Soak		
Temperature min (T_{smin})	100 °C	150 °C
Temperature max (T_{smax})	150 °C	200 °C
Time (T_{smin} to T_{smax}) (t_s)	60-120 seconds	60-120 seconds
Average ramp-up rate (T_{smax} to T_p)	3 °C/second max.	3°C/second max.
Liquidous temperature (T_L)	183 °C	217 °C
Time at liquidous (t_L)	60-150 seconds	60-150 seconds
Peak package body Temperature (T_p)*	See Classification Temp in table 1	See Classification Temp in table 2
Time (t_p)** within 5°C of the specified classification temperature (T_c)	20** seconds	30** seconds
Average ramp-down rate (T_p to T_{smax})	6 °C/second max.	6 °C/second max.
Time 25°C to peak temperature	6 minutes max.	8 minutes max.
* Tolerance for peak profile Temperature (T_p) is defined as a supplier minimum and a user maximum.		
** Tolerance for time at peak profile temperature (t_p) is defined as a supplier minimum and a user maximum.		

Table 1. SnPb Eutectic Process – Classification Temperatures (T_c)

Package Thickness	Volume mm ³ <350	Volume mm ³ ≥350
<2.5 mm	235 °C	220 °C
≥2.5 mm	220 °C	220 °C

Table 2. Pb-free Process – Classification Temperatures (T_c)

Package Thickness	Volume mm ³ <350	Volume mm ³ 350-2000	Volume mm ³ >2000
<1.6 mm	260 °C	260 °C	260 °C
1.6 mm – 2.5 mm	260 °C	250 °C	245 °C
≥2.5 mm	250 °C	245 °C	245 °C

Reliability Test Program

Test item	Method	Description
SOLDERABILITY	JESD-22, B102	5 Sec, 245°C
HTRB	JESD-22, A108	1000 Hrs, 80% of VDS max @ T_{jmax}
HTGB	JESD-22, A108	1000 Hrs, 100% of VGS max @ T_{jmax}
PCT	JESD-22, A102	168 Hrs, 100%RH, 2atm, 121°C
TCT	JESD-22, A104	500 Cycles, -65°C~150°C

Customer Service

Sinopower Semiconductor, Inc.

5F, No. 6, Dusing 1St Rd., Hsinchu Science Park,

Hsinchu, 30078, Taiwan

TEL: 886-3-5635818 Fax: 886-3-5642050