

**Performance Specification**

Model	V <sub>max</sub>	I <sub>max</sub>	I <sub>hold</sub>	I <sub>trip</sub>	P <sub>d</sub>	Maximum		Resistance	
						Time To Trip			
			@25°C	@25°C	Typ.	Current	Time	R <sub>i min</sub>	R <sub>1max</sub>
	(V dc)	(A)	(A)	(A)	(W)	(A)	(Sec)	(Ω)	(Ω)
JK-mSMD 010SF	30.0	100	0.10	0.30	0.8	0.5	1.50	0.750	15.000
JK-mSMD 014SF	60.0	100	0.14	0.34	0.8	1.5	0.15	0.650	6.000
JK-mSMD 020SF	30.0	100	0.20	0.40	0.8	8.0	0.02	0.350	5.000
JK-mSMD 030SF	30.0	100	0.30	0.60	0.8	8.0	0.10	0.250	3.000
JK-mSMD 050SF	15.0	100	0.50	1.00	0.8	8.0	0.15	0.150	1.000
JK-mSMD 050SF/33V	33.0	100	0.50	1.00	0.8	8.0	0.15	0.150	1.000
JK-mSMD 050SF/60V	60.0	100	0.50	1.00	0.8	8.0	0.15	0.150	1.400
JK-mSMD 075SF	13.2	100	0.75	1.50	0.8	8.0	0.20	0.090	0.450
JK-mSMD 110SF	8.0	100	1.10	2.20	0.8	8.0	0.30	0.050	0.250
JK-mSMD 110SF/16V	16.0	100	1.10	2.20	0.8	8.0	0.30	0.050	0.250
JK-mSMD 125SF	16.0	100	1.25	2.50	0.8	8.0	0.40	0.050	0.140
JK-mSMD 150SF	8.0	100	1.50	3.00	0.8	8.0	0.50	0.040	0.160
JK-mSMD 150SF/16V	16.0	100	1.50	3.00	0.8	8.0	0.50	0.040	0.160
JK-mSMD 150SF/24V	24.0	100	1.50	3.00	0.8	8.0	0.50	0.040	0.160
JK-mSMD 160SF	8.0	100	1.60	2.80	0.8	8.0	1.00	0.030	0.130
JK-mSMD 200SF	8.0	100	2.00	4.00	0.8	8.0	2.00	0.020	0.100
JK-mSMD 260SF	8.0	100	2.60	5.00	0.8	8.0	2.50	0.015	0.050
JK-mSMD 300SF	8.0	100	3.00	5.00	0.8	8.0	4.00	0.012	0.040
JK-mSMD 350SF	6.0	100	3.50	6.00	2.0	10.0	4.00	0.008	0.030

V<sub>max</sub> = Maximum operating voltage device can withstand without damage at rated current (I<sub>max</sub>).

I<sub>max</sub> = Maximum fault current device can withstand without damage at rated voltage (V<sub>max</sub>).

I<sub>hold</sub> = Hold Current. Maximum current device will not trip in 25°C still air.

I<sub>trip</sub> = Trip Current. Minimum current at which the device will always trip in 25°C still air.

P<sub>d</sub> = Power dissipation when device is in the tripped state in 25°C still air environment at rated voltage.

R<sub>i min/max</sub> = Minimum/Maximum device resistance prior to tripping at 25°C.

R<sub>1max</sub> = Maximum device resistance is measured one hour post reflow.

CAUTION : Operation beyond the specified ratings may result in damage and possible arcing and flame.

**Environmental Specifications**

Test	Conditions	Resistance change
Passive aging	+85°C, 1000 hrs.	±5% typical
Humidity aging	+85°C, 85% R.H. , 168 hours	±5% typical
Thermal shock	+85°C to -40°C, 20 times	±33% typical
Resistance to solvent	MIL-STD-202, Method 215	No change
Vibration	MIL-STD-202, Method 201	No change
Ambient operating conditions : - 40 °C to +85 °C		
Maximum surface temperature of the device in the tripped state is 125 °C		

**Agency Approval and Environmental Compliance**

Agency	File Number	Regulation	Standard
UL	EN217453		2002/95/EC
TUV	pending		EN14582

**Thermal Derating Chart**

Recommended Hold Current(A) at Ambient Temperature(°C)

Model	Ambient Operation Temperature								
	-40°C	-20°C	0°C	25°C	40°C	50°C	60°C	70°C	85°C
SMD1812-010SF	0.16	0.14	0.12	0.10	0.08	0.07	0.06	0.05	0.03
SMD1812-014SF	0.23	0.19	0.17	0.14	0.12	0.10	0.09	0.08	0.06
SMD1812-020SF	0.29	0.26	0.23	0.20	0.17	0.15	0.14	0.12	0.10
SMD1812-030SF	0.44	0.39	0.35	0.30	0.26	0.23	0.21	0.18	0.15
SMD1812-050SF	0.59	0.57	0.55	0.50	0.45	0.43	0.35	0.30	0.23
SMD182-075SF	1.10	0.99	0.87	0.75	0.63	0.57	0.49	0.45	0.35
SMD1812-110SF	1.60	1.45	1.28	1.10	0.92	0.83	0.71	0.66	0.52
SMD1812-110SF16V	1.59	1.44	1.27	1.10	0.92	0.82	0.70	0.64	0.50
SMD1812-125SF	2.00	1.75	1.52	1.25	1.00	0.95	0.90	0.75	0.53
SMD1812-150SF	2.30	2.05	1.77	1.50	1.23	1.09	0.95	0.82	0.61
SMD1812-150SF16V	2.28	2.03	1.75	1.50	1.21	1.07	0.93	0.79	0.58
SMD1812-160SF	2.10	1.96	1.88	1.60	1.26	1.12	0.98	0.84	0.63
SMD1812-200SF	2.88	2.61	2.25	2.00	1.80	1.66	1.45	1.09	0.80
SMD1812-260SF	3.90	3.42	2.96	2.60	2.33	2.07	1.94	1.35	1.00
SMD1812-300SF	4.15	3.76	3.46	3.00	2.55	2.28	2.01	1.61	1.33
SMD1812-350SF	4.84	4.39	4.04	3.50	2.98	2.66	2.35	1.88	1.55

**Thermal Derating Curve**

**Average Time-Current Curve**

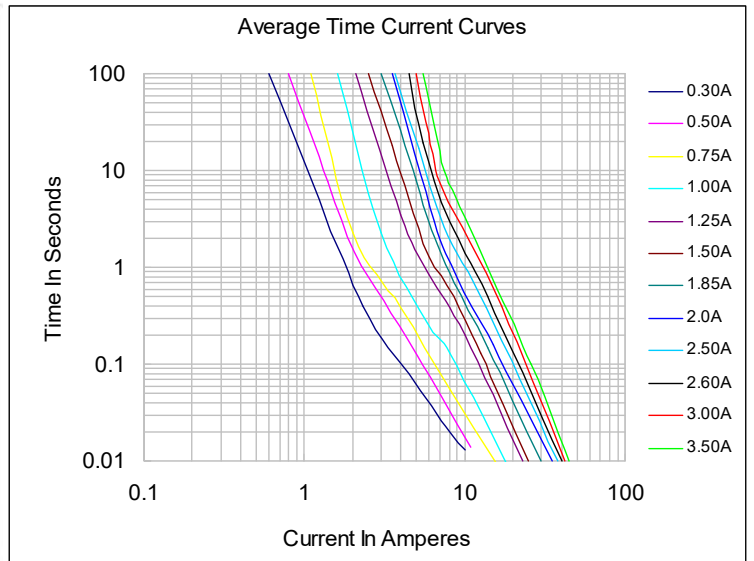
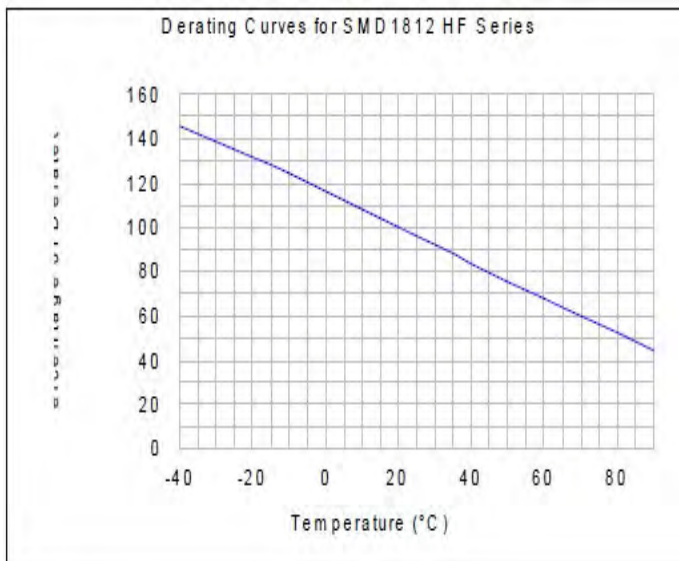

**Soldering Parameters**

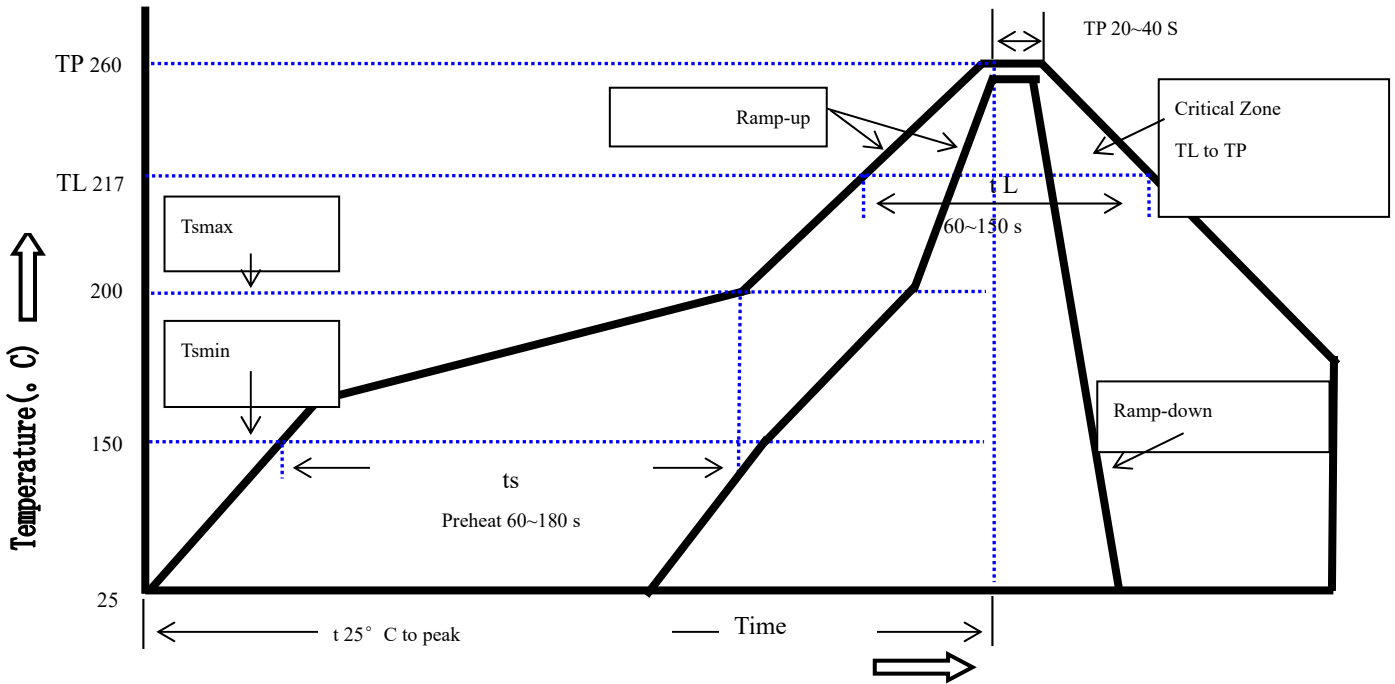

Profile Feature	Pb-Free Assembly
Average Ramp-Up Rate(Ts max to T p)	3°C/second max.
Preheat	
-Temperature Min(Ts min)	150°C
-Temperature Max(Ts max)	200°C
-Time(Ts min to Ts max)	60~180 seconds
Time maintained above:	
-Temperature(TL)	217°C
-Time(tL)	60~150 seconds
Peak Temperature(Tp)	260°C
Ramp-Down Rate	6°C/second max.
Time 25°C to Peak Temperature	8 minutes max
Storage Condition	0°C~35°C, ≤70%RH

Recommended reflow methods: IR, vapor phase oven, hot air oven, N2 environment for lead-free

Recommended maximum paste thickness is 0.25mm

Devices can be cleaned using standard industry methods and solvents.

Note 1: All temperature refer to topside of the package, measured on the package body surface.

Note 2: If reflow temperatures exceed the recommended profile, devices may not meet the performance requirements.

**Physical Dimensions(mm.)**

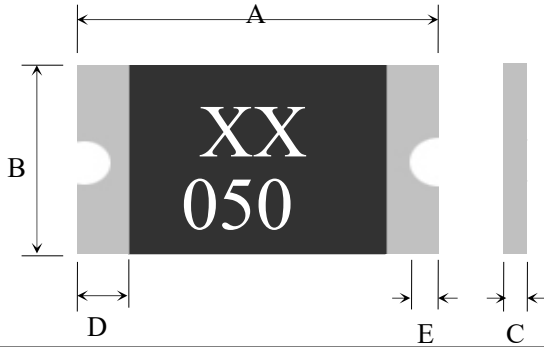

Model	A		B		C		D	E
	Min.	Max.	Min.	Max.	Min.	Max.	Min.	Min.
SMD1812-010SF	4.37	4.73	3.07	3.41	0.50	1.00	0.30	0.25
SMD1812-014SF	4.37	4.73	3.07	3.41	0.50	1.00	0.30	0.25
SMD1812-020SF	4.37	4.73	3.07	3.41	0.50	1.30	0.30	0.25
SMD1812-030SF	4.37	4.73	3.07	3.41	0.50	1.00	0.30	0.25
SMD1812-050SF	4.37	4.73	3.07	3.41	0.40	0.90	0.30	0.25
SMD1812-050SF33V	4.37	4.73	3.07	3.41	0.70	1.30	0.30	0.25
SMD1812-050SF60V	4.37	4.73	3.07	3.41	1.10	1.80	0.30	0.25
SMD182-075SF	4.37	4.73	3.07	3.41	0.40	0.90	0.30	0.25
SMD1812-110SF	4.37	4.73	3.07	3.41	0.40	0.90	0.30	0.25
SMD1812-110SF16V	4.37	4.73	3.07	3.41	0.60	1.30	0.30	0.25
SMD1812-125SF	4.37	4.73	3.07	3.41	0.60	1.30	0.30	0.25
SMD1812-150SF	4.37	4.73	3.07	3.41	0.40	1.20	0.30	0.25
SMD1812-150SF16V	4.37	4.73	3.07	3.41	0.40	1.20	0.30	0.25
SMD1812-160SF	4.37	4.73	3.07	3.41	0.40	1.20	0.30	0.25
SMD1812-200SF	4.37	4.73	3.07	3.41	0.50	1.30	0.30	0.25
SMD1812-260SF	4.37	4.73	3.07	3.41	0.50	1.50	0.30	0.25
SMD1812-300SF	4.37	4.73	3.07	3.41	0.50	1.50	0.30	0.25
SMD1812-350SF	4.37	4.73	3.07	3.41	0.50	1.50	0.30	0.25

**Termination Pad Characteristics**

Terminal pad materials: Tin-plated Nickel-Copper

Terminal pad solder ability: Meets EIA specification RS186-9E and ANSI/J-STD-002 Category 3.

**Recommended Pad Layout (mm.)**

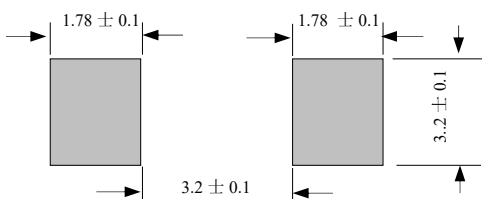

**Packaging Quantity**

Part Number	Quantity
SMD812 Series	1,500 pcs/reel

Tape & reel packaging per EIA481-1

**Tape And Reel Specifications (mm)**

**Governing**

Specifications	EIA 481-1
W	12 ± 0.3
P0	4.0 ± 0.10
P1	8.0 ± 0.10
P2	2.0 ± 0.05
A0	3.5 ± 0.10
B0	5.1 ± 0.10
B1max.	5.9
D0	1.50 + 0.1, -0
F	5.5 ± 0.05
E1	1.75 ± 0.10
E2min.	10.25
T	0.6
T1max.	0.1
K0	0.9 ± 0.1
Leader min.	390
Trailer min.	160
<b>Reel Dimensions</b>	
A max.	178
N min.	60
W1	12.4 ± 0.5
W2	18.4

EIA Tape Component Dimensions

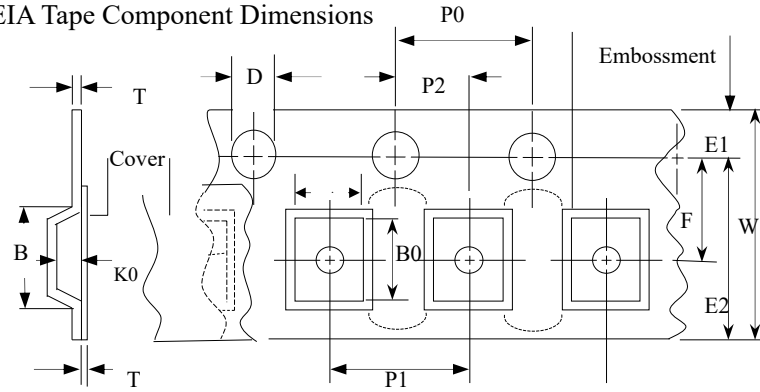

EIA Reel Dimensions

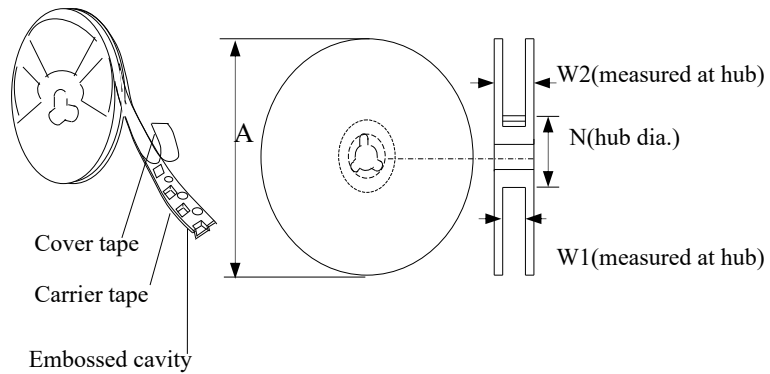

**Storage And Handling**

- Storage conditions: 35°C max, 70% R.H.
- Devices may not meet specified performance if storage conditions are exceeded.

**Part Number System**

JK - mSMD □□□ S F □□ V

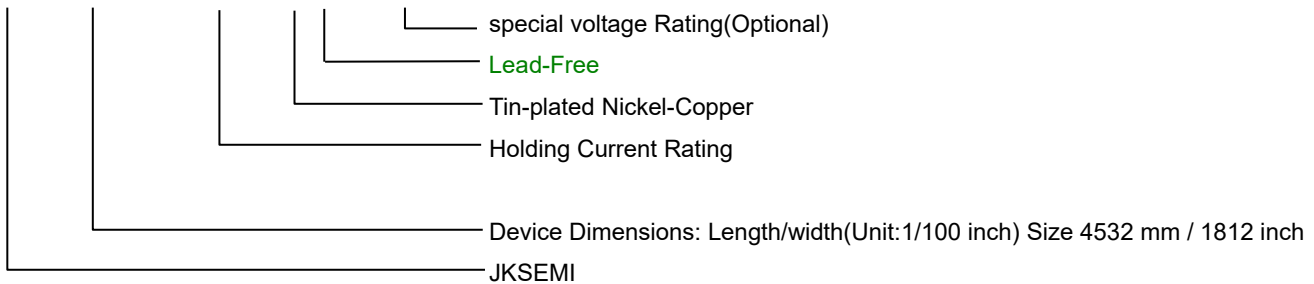

**Cross Reference**

Darong	Cross Reference				
	TYCO/Raychem	Littelfuse	Bourns / Multifuse®	Polytronics / EVERFUSE®	SEA-LAND
SMD1812-010SF	miniSMDC010F	1812L010	MF-MSMF010	SMD1812P010TF	mSMD010
SMD1812-014SF	-miniSMDC014F	1812L014	MF-MSMF014	SMD1812P014TF	mSMD014
SMD1812-020SF	miniSMDC020F	1812L020	MF-MSMF020	SMD1812P020TF	mSMD020
SMD1812-030SF	-	1812L030	MF-MSMF030	SMD1812P030TF	mSMD030
SMD1812-050SF	miniSMDC050F	1812L050	MF-MSMF050	SMD1812P050TF	mSMD050
SMD1812-050SF33V	miniSMDC050F	1812L050-30	-	SMD1812P050TF/30	mSMD050-33V
SMD1812-050SF60V	-	1812L050-60	-	-	mSMD050-60V
SMD182-075SF	miniSMDC750F	1812L075	MF-MSMF075	SMD1812P075TF	mSMD075
SMD1812-110SF	miniSMDC110F	1812L110	MF-MSMF110	SMD1812P110TF	mSMD110
SMD1812-110SF16V	miniSMDC110F/16	-	MF-MSMF110/16	SMD1812P110TF/16	mSMD110-16V
SMD1812-125SF	miniSMDC125F	1812L125	MF-MSMF125	SMD1812P125TF	mSMD125
SMD1812-150SF	miniSMDC150F	1812L150	MF-MSMF150	SMD1812P150TF	mSMD150
SMD1812-150SF16V	miniSMDC150F/12	1812L150-12	-	SMD1812P150TF/12	mSMD150-16V
SMD1812-160SF	miniSMDC160F	1812L160	MF-MSMF160	SMD1812P160TF	mSMD160
SMD1812-200SF	miniSMDC200F	1812L200	MF-MSMF200	SMD1812P200TFT	mSMD200
SMD1812-260SF	miniSMDC260F	1812L260	MF-MSMF260	SMD1812P260TFT	mSMD260
SMD1812-300SF	miniSMDC300F	1812L300	-	SMD1812P300TFT	mSMD300
SMD1812-350SF	-	-	-	-	mSMD350

“Raychem” is a registered trademark of Tyco Electronics.

“Littelfuse” is a registered trademark of Littelfuse

“Multifuse” is a registered trademark of bourns, Inc.

“EVERFUSE” is a registered trademark of Polytronics Technology Corp.

“SEA-LAND” is a registered trademark of Sea-Land electronic corp.

Website: <http://www.jksemi.com>

For additional information, please contact your local Sales Representative.

©Copyright 2016, jk semi