

CRYSTAL OSCILLATOR (Programmable) OUTPUT: CMOS

SG-8101 series

- Frequency range : 0.67 MHz to 170 MHz (1 ppm Step)
- Supply voltage : 1.62 V to 3.63 V
- Function : Output enable (OE) or Standby (\overline{ST})
- Frequency tolerance, operating temperature:
 - ±15 ppm (-40 °C to +85 °C)
 - ±20 ppm, ±50 ppm (-40 °C to +105 °C)
- Package : 2.5 x 2.0, 3.2 x 2.5, 5.0 x 3.2, 7.0 x 5.0 (mm)
- PLL technology to enable short lead time
- Available field oscillator programmer "SG-Writer II"



Product Number (please contact us)
 SG-8101CA: X1G005191xxxx00
 SG-8101CB: X1G005201xxxx00
 SG-8101CE: X1G005211xxxx00
 SG-8101CG: X1G005181xxxx00

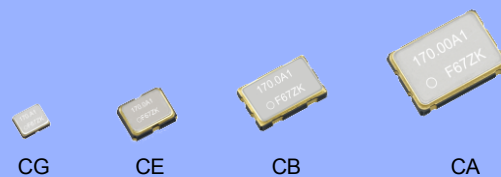

Specifications (characteristics)

Item	Symbol	Specifications				Conditions/Remarks																																														
Supply voltage	V_{CC}	1.80 V Typ.		2.50 V Typ.	3.30 V Typ.	-																																														
		1.62 V to 1.98 V	1.98 V to 2.20 V	2.20 V to 2.80 V	2.70 V to 3.63 V																																															
Output frequency range	f_o	0.67 MHz to 170 MHz																																																		
Storage temperature	T_{stg}	-40 °C to +125 °C				Storage as single product.																																														
Operating temperature	T_{use}	-40 °C to +85 °C				-																																														
		-40 °C to +105 °C				-																																														
Frequency tolerance**1	f_{tol}	B: ±15 × 10 ⁻⁶				$T_{use} = -40 °C$ to +85 °C																																														
		C: ±20 × 10 ⁻⁶				$T_{use} = -40 °C$ to +105 °C																																														
		J: ±50 × 10 ⁻⁶				$T_{use} = -40 °C$ to +105 °C																																														
Current consumption	I_{CC}	3.2 mA Max.	3.3 mA Max.	3.4 mA Max.	3.5 mA Max.	$T_{use} = +105 °C$	No load, $f_o = 20$ MHz																																													
		2.7 mA Typ.		2.9 mA Typ.	3.0 mA Typ.	$T_{use} = +25 °C$																																														
		5.5 mA Max.	5.8 mA Max.	6.7 mA Max.	8.1 mA Max.	$T_{use} = +105 °C$	No load, $f_o = 170$ MHz																																													
		4.7 mA Typ.		5.7 mA Typ.	6.8 mA Typ.	$T_{use} = +25 °C$																																														
Output disable current	I_{dis}	3.2 mA Max.	3.2 mA Max.	3.3 mA Max.	3.5 mA Max.	OE = GND, $f_o = 170$ MHz																																														
Standby current	I_{std}	0.9 µA Max.	1.0 µA Max.	1.5 µA Max.	2.5 µA Max.	$T_{use} = +105 °C$																																														
		0.3 µA Typ.	0.4 µA Typ.	0.5 µA Typ.	1.1 µA Typ.	$T_{use} = +25 °C$																																														
Symmetry	SYM	45 % to 55 %				50 % V_{CC} Level																																														
Output voltage (DC characteristics)	V_{OH}	90 % V_{CC} Min.				<table border="1"> <thead> <tr> <th colspan="6">IOH/IOL Conditions [mA]</th> </tr> <tr> <th>Rise/Fall time</th> <th>V_{CC}</th> <th>*A</th> <th>*B</th> <th>*C</th> <th>*D</th> </tr> </thead> <tbody> <tr> <td rowspan="2">Default ($f_o > 40$ MHz)</td> <td>IOH</td> <td>-2.5</td> <td>-3.5</td> <td>-4.0</td> <td>-5.0</td> </tr> <tr> <td>IOL</td> <td>2.5</td> <td>3.5</td> <td>4.0</td> <td>5.0</td> </tr> <tr> <td rowspan="2">Default ($f_o \leq 40$ MHz)</td> <td>IOH</td> <td>-1.5</td> <td>-2.0</td> <td>-2.5</td> <td>-3.0</td> </tr> <tr> <td>IOL</td> <td>1.5</td> <td>2.0</td> <td>2.5</td> <td>3.0</td> </tr> <tr> <td rowspan="2">Slow</td> <td>IOH</td> <td>-1.0</td> <td>-1.5</td> <td>-2.0</td> <td>-2.5</td> </tr> <tr> <td>IOL</td> <td>1.0</td> <td>1.5</td> <td>2.0</td> <td>2.5</td> </tr> </tbody> </table>		IOH/IOL Conditions [mA]						Rise/Fall time	V_{CC}	*A	*B	*C	*D	Default ($f_o > 40$ MHz)	IOH	-2.5	-3.5	-4.0	-5.0	IOL	2.5	3.5	4.0	5.0	Default ($f_o \leq 40$ MHz)	IOH	-1.5	-2.0	-2.5	-3.0	IOL	1.5	2.0	2.5	3.0	Slow	IOH	-1.0	-1.5	-2.0	-2.5	IOL	1.0	1.5	2.0	2.5
	IOH/IOL Conditions [mA]																																																			
Rise/Fall time	V_{CC}	*A	*B	*C	*D																																															
Default ($f_o > 40$ MHz)	IOH	-2.5	-3.5	-4.0	-5.0																																															
	IOL	2.5	3.5	4.0	5.0																																															
Default ($f_o \leq 40$ MHz)	IOH	-1.5	-2.0	-2.5	-3.0																																															
	IOL	1.5	2.0	2.5	3.0																																															
Slow	IOH	-1.0	-1.5	-2.0	-2.5																																															
	IOL	1.0	1.5	2.0	2.5																																															
V_{OL}	10 % V_{CC} Max.				*A: 1.62 V to 1.98 V, *B: 1.98 V to 2.20 V, *C: 2.20 V to 2.80 V, *D: 2.70 V to 3.63 V																																															
Output load condition	L_{CMOS}	15 pF Max.				-																																														
Input voltage	V_{IH}	70 % V_{CC} Min.				OE or \overline{ST}																																														
	V_{IL}	30 % V_{CC} Max.																																																		
Rise and Fall time	Default	$t_{r/f}$	3.0 ns Max.		$f_o > 40$ MHz		20 % - 80 % V_{CC} , $L_{CMOS} = 15$ pF																																													
			6.0 ns Max.		$f_o \leq 40$ MHz																																															
			3.0 ns Max.		$f_o = 0.67$ MHz to 170 MHz																																															
			10.0 ns Max.		$f_o = 0.67$ MHz to 20 MHz																																															
Disable Time	t_{stp}	1 µs Max.		Measured from the time OE or \overline{ST} pin crosses 30 % V_{CC}																																																
Enable Time	t_{sta}	1 µs Max.		Measured from the time OE pin crosses 70 % V_{CC}																																																
Resume Time	t_{res}	3 ms Max.		Measured from the time \overline{ST} pin crosses 70 % V_{CC}																																																
Start-up time	t_{str}	3 ms Max.		Measured from the time V_{CC} reaches its rated minimum value, 1.62 V																																																
Frequency aging	f_{aging}	This is included in frequency tolerance specification.				+25 °C, first year																																														

*1 Frequency tolerance includes initial frequency tolerance, temperature variation, supply voltage variation, reflow drift, load drift and aging (+25 °C, 1 year).

Pin description

Pin	Name	I/O type	Function	
1	OE	Input	Output enable	High: Specified frequency output from OUT pin Low: Out pin is low (weak pull down), only output driver is disabled.
	\overline{ST}	Input	Standby	High: Specified frequency output from OUT pin Low: Out pin is low (weak pull down), Device goes to standby mode. Supply current reduces to the least as I_{std} .
2	GND	Power	Ground	
3	OUT	Output	Clock output	
4	V_{CC}	Power	Power supply	



Product Name

SG-8101CG 170.000000MHz T C H P A

① ② ③ ④ ⑤ ⑥ ⑦ ⑧

- ① Model, ② Package type,
- ③ Frequency, ④ Supply voltage,
- ⑤ Frequency tolerance, ⑥ Operating temperature,
- ⑦ Function, ⑧ Rise/Fall time

② Package type
CA: 7.0 mm x 5.0 mm
CB: 5.0 mm x 3.2 mm
CE: 3.2 mm x 2.5 mm
CG: 2.5 mm x 2.0 mm

④ Supply voltage
T: 1.8 V to 3.3 V Typ.

⑥ Operating temperature
G: -40 °C to +85 °C
H: -40 °C to +105 °C

⑧ Rise/Fall time
A: Default
B: Fast
C: Slow

⑤ Frequency tolerance
B: 15 x 10 ⁻⁶
C: 20 x 10 ⁻⁶
J: 50 x 10 ⁻⁶

⑦ Function
P: Output Enable
S: Standby

Available combination		CA: 7.0 mm x 5.0 mm			CB: 5.0 mm x 3.2 mm			CE: 3.2 mm x 2.5 mm			CG: 2.5 mm x 2.0 mm		
Frequency tolerance		B: 15 x 10 ⁻⁶	C: 20 x 10 ⁻⁶	J: 50 x 10 ⁻⁶	B: 15 x 10 ⁻⁶	C: 20 x 10 ⁻⁶	J: 50 x 10 ⁻⁶	B: 15 x 10 ⁻⁶	C: 20 x 10 ⁻⁶	J: 50 x 10 ⁻⁶	B: 15 x 10 ⁻⁶	C: 20 x 10 ⁻⁶	J: 50 x 10 ⁻⁶
Operating temperature	G: -40 °C to +85 °C	✓			✓			✓			✓		
	H: -40 °C to +105 °C		✓	✓		✓	✓		✓	✓		✓	✓

External dimensions (Unit: mm)

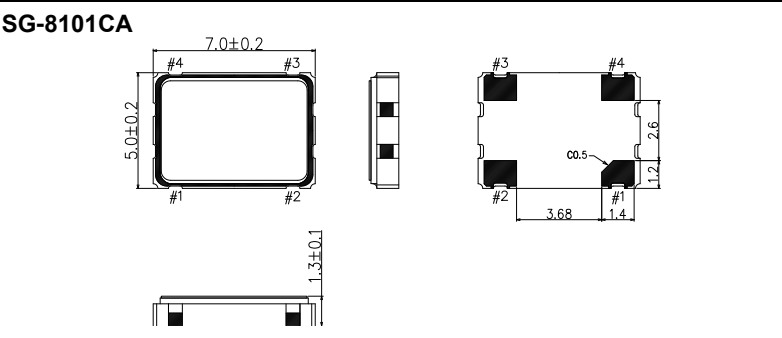
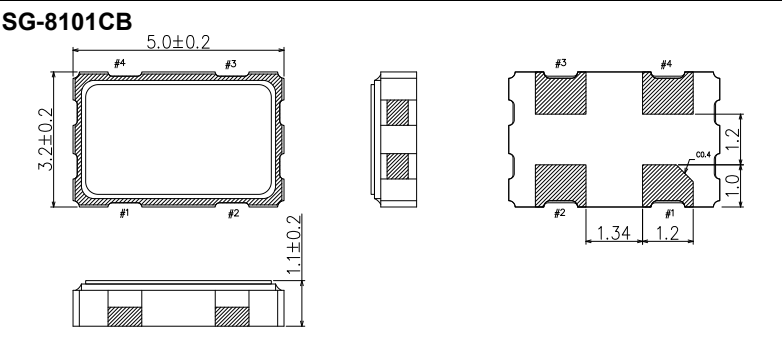
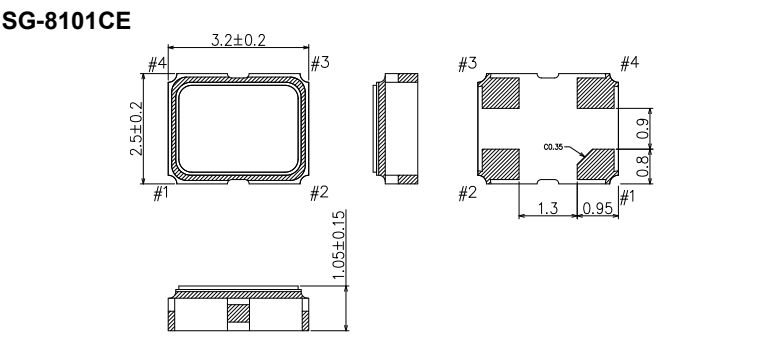
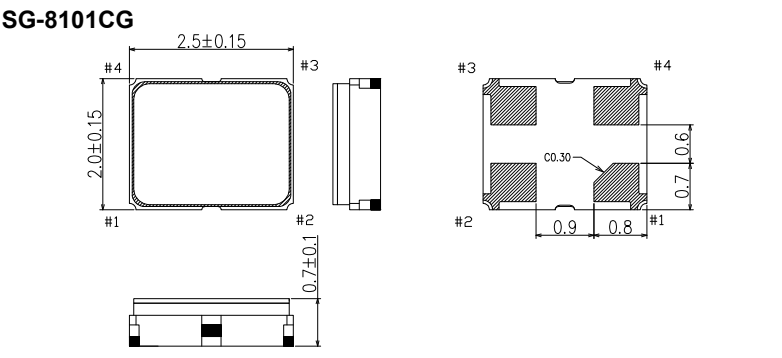

Footprint (Recommended) (Unit: mm)

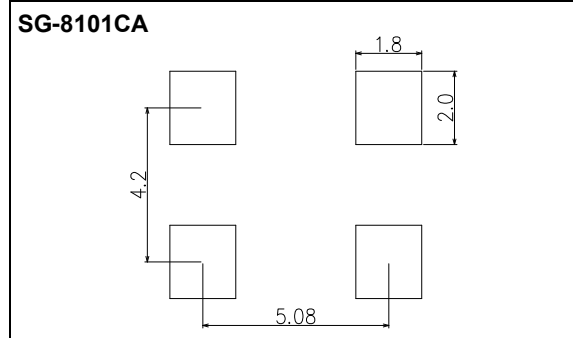
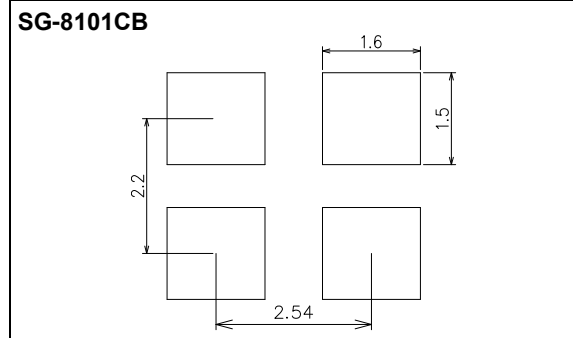
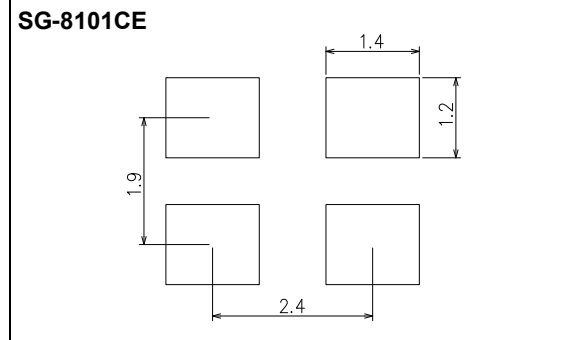
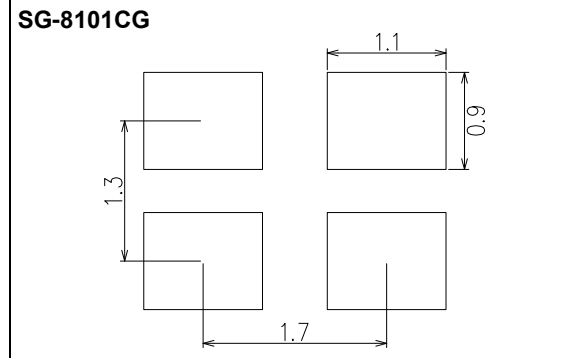

Notes:

In order to achieve optimum jitter performance, the 0.1 μF capacitor between V_{CC} and GND should be placed. It is also recommended that the capacitors are placed on the device side of the PCB, as close to the device as possible and connected together with short wiring pattern.



Specification Graph (Typical supplemental specification. Unless otherwise specified $T_{use} = 25\text{ }^{\circ}\text{C}$, $L_{CMOS} = 15\text{ pF}$)

Current Consumption

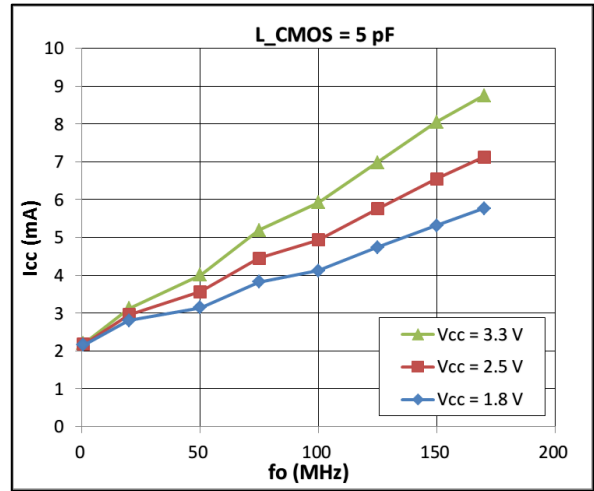
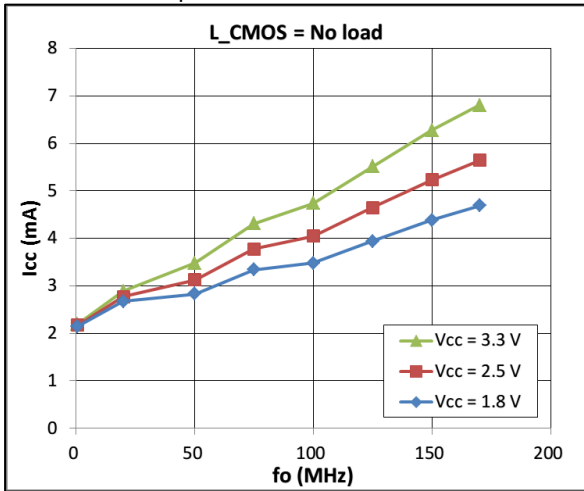

Output disable current



Standby current

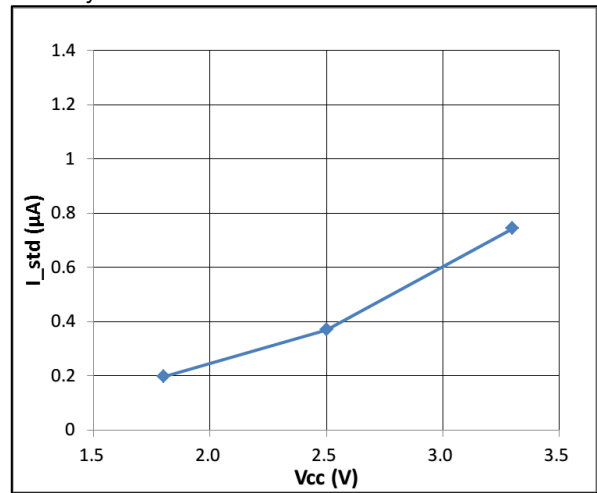

■ Notes:





Specification Graph (Typical supplemental specification. Unless otherwise specified $T_{use} = 25\text{ }^{\circ}\text{C}$, $L_{CMOS} = 15\text{ pF}$)

Phase Jitter RMS

(Integration bandwidth 12 k to 20 MHz)



Phase Jitter RMS

(Integration bandwidth 1.8 M to 20 MHz)



Period Jitter RMS

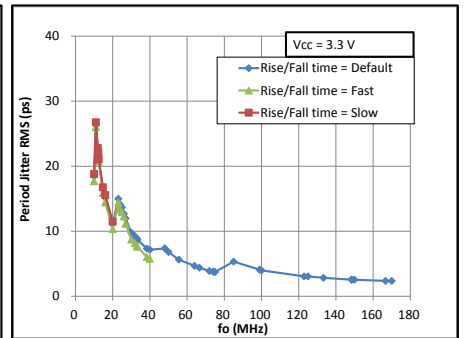
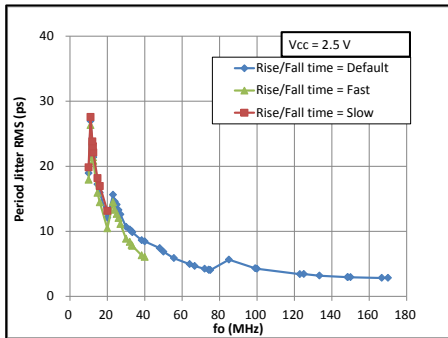

Period Jitter Peak-Peak

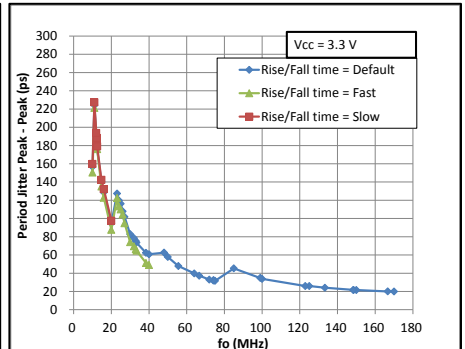
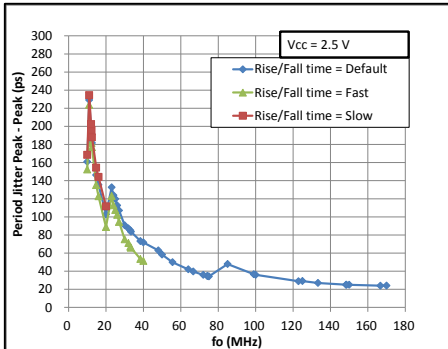
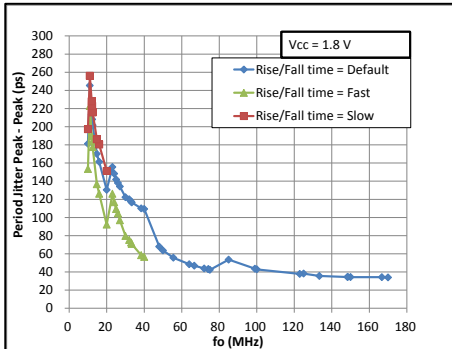

Cycle-to-Cycle Jitter Peak-Peak

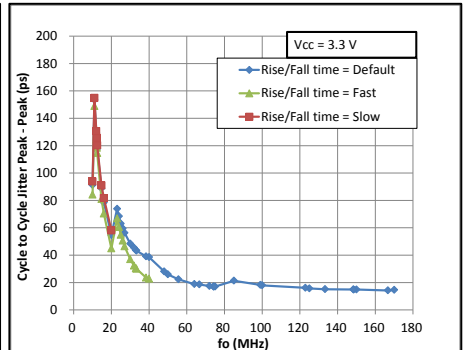
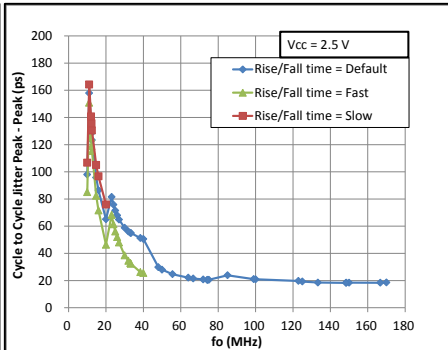

■ Notes:

Notes area containing empty space for additional information.

Specification Graph

(Typical supplemental specification. Unless otherwise specified $T_{use} = 25\text{ }^{\circ}\text{C}$, $L_{CMOS} = 15\text{ pF}$, $V_{CC} = 3.3\text{ V}$)

Rise/Fall Time ($f_o = 20\text{ MHz}$)

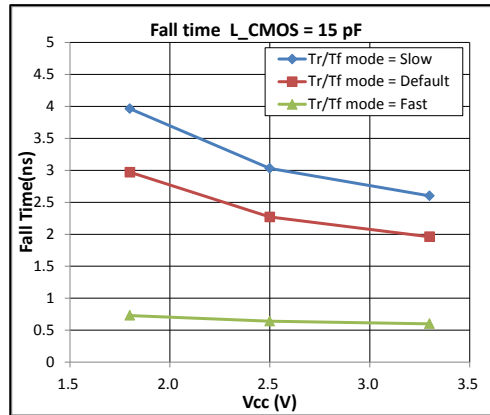
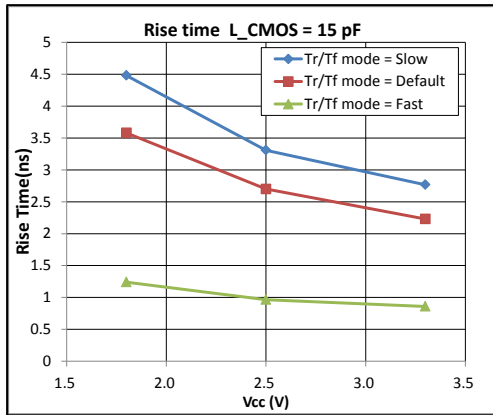
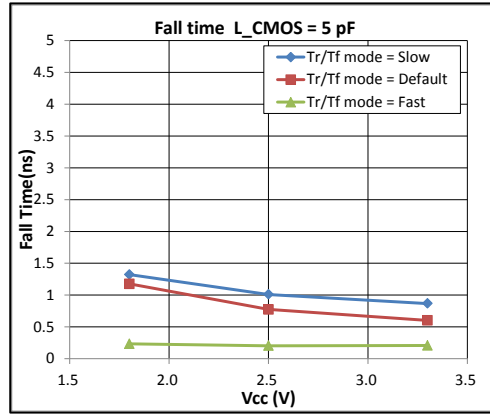

Harmonics spectrum ($f_o = 20\text{ MHz}$)

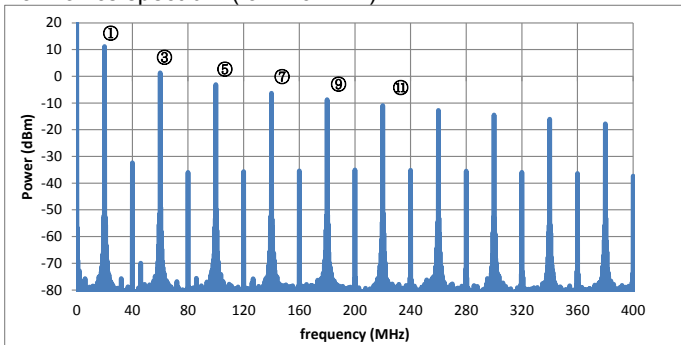

Harmonics comparison

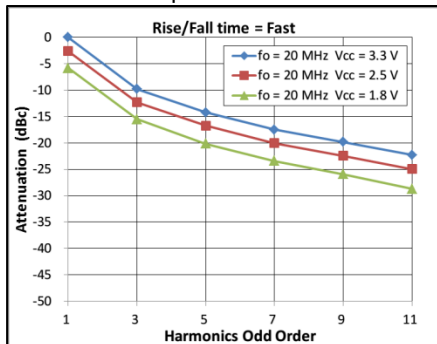

Normalize to $V_{CC} = 3.3\text{ V}$.

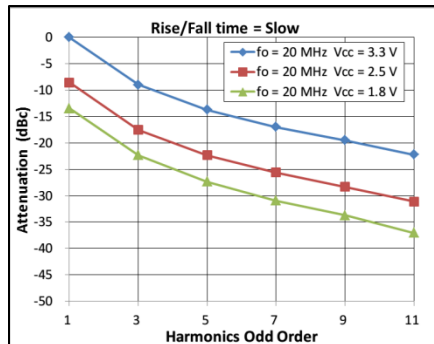

Normalize to $V_{CC} = 3.3\text{ V}$.

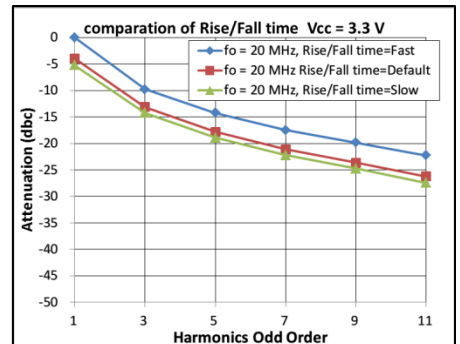

Normalize to Rise/Fall time = "Fast".

Notes:

frequency	slow	default	fast
0.67 M – 20 MHz	See Slow	See Default	See Fast
20 M – 40 MHz	-	See Default	See Fast
40 M – 170 MHz	-	See Fast	See Fast



ESD Rating

Test items	Breakdown voltage
Human Body Model (HBM)	2000 V
Machine Model (MM)	250 V
Charged Device Model (CDM)	750 V

Device Marking (Standard specification)

Model	Factory Programmed Part Marking	Field Programmable Part Marking (Blank Samples)
SG-8101CG		
SG-8101CE		
SG-8101CB		
SG-8101CA		

Simulation Model

- IBIS Model is available upon request. Please contact us.
Information Required: Oscillator operating condition (i.e. Power Supply, Rise/Fall Time, Temperature)



Device Material & Environmental Information

Model	Package Dimensions	# of Pins	Reference Weight (Typ.)	Terminal Material	Terminal Plating	Complies With EU RoHS	Pb Free	MSL Rating	Peak Temp. (Max)
SG-8101CG	2.5 x 2.0 x 0.7 mm	4	13 mg	W	Au	Yes	Yes	1	260 °C
SG-8101CE	3.2 x 2.5 x 1.0 mm	4	25 mg	W	Au	Yes	Yes	1	260 °C
SG-8101CB	5.0 x 3.2 x 1.1 mm	4	51 mg	W	Au	Yes	Yes	1	260 °C
SG-8101CA	7.0 x 5.0 x 1.3 mm	4	143 mg	W	Au	Yes	Yes	1	260 °C

SMD products Reflow profile(example)

The availability of the heat resistance for reflow conditions of JEDEC-STD-020D.01 is judged individually. Please inquire.



	<ul style="list-style-type: none"> Pb free.
	<ul style="list-style-type: none"> Complies with EU RoHS directive. <ul style="list-style-type: none"> About the products without the Pb-free mark. Contains Pb in products exempted by EU RoHS directive. (Contains Pb in sealing glass, high melting temperature type solder or other.)

Standard Packing Specification

SMD products are packed in the shipping carton as below table in accordance with taping standards EIA-481 and IEC-60286



Standard Packing Quantity & Dimension(Unit mm)

Model	Quantity (pcs/Reel)	Reel Dimension			Career Tape Dimension				Direction of Feed (L= Left Direction)
		a	b	W	A	B	C	D	
SG-8101CG	3000	Φ180	Φ60	9	4	5.25	8	1.15	L
SG-8101CE	2000	Φ180	Φ60	9	4	5.25	8	1.4	L
SG-8101CB	1000	Φ180	Φ60	13	8	7.25	12	1.4	L
SG-8101CA	1000	Φ254	Φ100	17.5	8	9.25	16	2.3	L

PROMOTION OF ENVIRONMENTAL MANAGEMENT SYSTEM CONFORMING TO INTERNATIONAL STANDARDS

At Seiko Epson, all environmental initiatives operate under the Plan-Do-Check-Action (PDCA) cycle designed to achieve continuous improvements. The environmental management system (EMS) operates under the ISO 14001 environmental management standard.

All of our major manufacturing and non-manufacturing sites, in Japan and overseas, completed the acquisition of ISO 14001 certification.

ISO 14000 is an international standard for environmental management that was established by the International Standards Organization in 1996 against the background of growing concern regarding global warming, destruction of the ozone layer, and global deforestation.

WORKING FOR HIGH QUALITY

In order provide high quality and reliable products and services than meet customer needs,

Seiko Epson made early efforts towards obtaining ISO9000 series certification and has acquired ISO9001 for all business establishments in Japan and abroad. We have also acquired ISO/TS 16949 certification that is requested strongly by major automotive manufacturers as standard.

ISO/TS16949 is the international standard that added the sector-specific supplemental requirements for automotive industry based on ISO9001.

► Explanation of the mark that are using it for the catalog

	► Pb free.
	► Complies with EU RoHS directive. *About the products without the Pb-free mark. Contains Pb in products exempted by EU RoHS directive. (Contains Pb in sealing glass, high melting temperature type solder or other.)
	► Designed for automotive applications such as Car Multimedia, Body Electronics, Remote Keyless Entry etc.
	► Designed for automotive applications related to driving safety (Engine Control Unit, Air Bag, ESC etc).

Notice

- This material is subject to change without notice.
- Any part of this material may not be reproduced or duplicated in any form or any means without the written permission of Seiko Epson.
- The information about applied data, circuitry, software, usage, etc. written in this material is intended for reference only. Seiko Epson does not assume any liability for the occurrence of customer damage or infringing on any patent or copyright of a third party. This material does not authorize the licensing for any patent or intellectual copyrights.
- When exporting the products or technology described in this material, you should comply with the applicable export control laws and regulations and follow the procedures required by such laws and regulations.
- You are requested not to use the products (and any technical information furnished, if any) for the development and/or manufacture of weapon of mass destruction or for other military purposes. You are also requested that you would not make the products available to any third party who may use the products for such prohibited purposes.
- These products are intended for general use in electronic equipment. When using them in specific applications that require extremely high reliability, such as the applications stated below, you must obtain permission from Seiko Epson in advance.
/ Space equipment (artificial satellites, rockets, etc.) / Transportation vehicles and related (automobiles, aircraft, trains, vessels, etc.) / Medical instruments to sustain life / Submarine transmitters / Power stations and related / Fire work equipment and security equipment / traffic control equipment / and others requiring equivalent reliability.
- All brands or product names mentioned herein are trademarks and/or registered trademarks of their respective.