

**CRYSTAL OSCILLATOR (Programmable)**  
**OUTPUT: CMOS**
**SG-8101 series**

- Frequency range : 0.67 MHz to 170 MHz (1 ppm Step)
- Supply voltage : 1.62 V to 3.63 V
- Function : Output enable (OE) or Standby ( $\overline{ST}$ )
- Frequency tolerance, operating temperature:
  - ±15 ppm (-40 °C to +85 °C)
  - ±20 ppm, ±50 ppm (-40 °C to +105 °C)
- Package : 2.5 x 2.0, 3.2 x 2.5, 5.0 x 3.2, 7.0 x 5.0 (mm)
- PLL technology to enable short lead time
- Available field oscillator programmer "SG-Writer II"

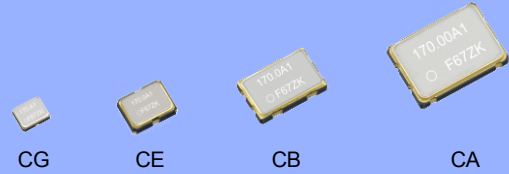

Product Number (please contact us)  
 SG-8101CA: X1G005191xxxx00  
 SG-8101CB: X1G005201xxxx00  
 SG-8101CE: X1G005211xxxx00  
 SG-8101CG: X1G005181xxxx00

**Specifications (characteristics)**

| Item                                   | Symbol                  | Specifications   |                  |   |   | Conditions/Remarks  |  |                         |  |  |  |  |  |                |          |    |    |    |    |                                    |     |      |      |      |      |     |     |     |     |     |                              |     |      |      |      |      |     |     |     |     |     |      |     |      |      |      |      |     |     |     |     |     |
|--|-------------------------|--|------------------|---|---|---|--|-------------------------|--|--|--|--|--|----------------|----------|----|----|----|----|------------------------------------|-----|------|------|------|------|-----|-----|-----|-----|-----|------------------------------|-----|------|------|------|------|-----|-----|-----|-----|-----|------|-----|------|------|------|------|-----|-----|-----|-----|-----|
| Supply voltage                         | $V_{CC}$                | 1.80 V Typ.  |                  | 2.50 V Typ.   | 3.30 V Typ.   | -   |  |                         |  |  |  |  |  |                |          |    |    |    |    |                                    |     |      |      |      |      |     |     |     |     |     |                              |     |      |      |      |      |     |     |     |     |     |      |     |      |      |      |      |     |     |     |     |     |
|  |                         | 1.62 V to 1.98 V                                       | 1.98 V to 2.20 V | 2.20 V to 2.80 V  | 2.70 V to 3.63 V  |   |  |                         |  |  |  |  |  |                |          |    |    |    |    |                                    |     |      |      |      |      |     |     |     |     |     |                              |     |      |      |      |      |     |     |     |     |     |      |     |      |      |      |      |     |     |     |     |     |
| Output frequency range                 | $f_o$                   | 0.67 MHz to 170 MHz                                    |                  |   |   |   |  |                         |  |  |  |  |  |                |          |    |    |    |    |                                    |     |      |      |      |      |     |     |     |     |     |                              |     |      |      |      |      |     |     |     |     |     |      |     |      |      |      |      |     |     |     |     |     |
| Storage temperature                    | $T_{stg}$               | -40 °C to +125 °C                                      |                  |   |   | Storage as single product.  |  |                         |  |  |  |  |  |                |          |    |    |    |    |                                    |     |      |      |      |      |     |     |     |     |     |                              |     |      |      |      |      |     |     |     |     |     |      |     |      |      |      |      |     |     |     |     |     |
| Operating temperature                  | $T_{use}$               | -40 °C to +85 °C                                       |                  |   |   | -   |  |                         |  |  |  |  |  |                |          |    |    |    |    |                                    |     |      |      |      |      |     |     |     |     |     |                              |     |      |      |      |      |     |     |     |     |     |      |     |      |      |      |      |     |     |     |     |     |
|  |                         | -40 °C to +105 °C                                      |                  |   |   | -   |  |                         |  |  |  |  |  |                |          |    |    |    |    |                                    |     |      |      |      |      |     |     |     |     |     |                              |     |      |      |      |      |     |     |     |     |     |      |     |      |      |      |      |     |     |     |     |     |
| Frequency tolerance**1                 | $f_{tol}$               | B: ±15 × 10 <sup>-6</sup>                              |                  |   |   | $T_{use} = -40 °C$ to +85 °C  |  |                         |  |  |  |  |  |                |          |    |    |    |    |                                    |     |      |      |      |      |     |     |     |     |     |                              |     |      |      |      |      |     |     |     |     |     |      |     |      |      |      |      |     |     |     |     |     |
|  |                         | C: ±20 × 10 <sup>-6</sup>                              |                  |   |   | $T_{use} = -40 °C$ to +105 °C   |  |                         |  |  |  |  |  |                |          |    |    |    |    |                                    |     |      |      |      |      |     |     |     |     |     |                              |     |      |      |      |      |     |     |     |     |     |      |     |      |      |      |      |     |     |     |     |     |
|  |                         | J: ±50 × 10 <sup>-6</sup>                              |                  |   |   | $T_{use} = -40 °C$ to +105 °C   |  |                         |  |  |  |  |  |                |          |    |    |    |    |                                    |     |      |      |      |      |     |     |     |     |     |                              |     |      |      |      |      |     |     |     |     |     |      |     |      |      |      |      |     |     |     |     |     |
| Current consumption                    | $I_{CC}$                | 3.2 mA Max.  | 3.3 mA Max.      | 3.4 mA Max.   | 3.5 mA Max.   | $T_{use} = +105 °C$   | No load, $f_o = 20$ MHz                      |                         |  |  |  |  |  |                |          |    |    |    |    |                                    |     |      |      |      |      |     |     |     |     |     |                              |     |      |      |      |      |     |     |     |     |     |      |     |      |      |      |      |     |     |     |     |     |
|  |                         | 2.7 mA Typ.  |                  | 2.9 mA Typ.   | 3.0 mA Typ.   | $T_{use} = +25 °C$  |  |                         |  |  |  |  |  |                |          |    |    |    |    |                                    |     |      |      |      |      |     |     |     |     |     |                              |     |      |      |      |      |     |     |     |     |     |      |     |      |      |      |      |     |     |     |     |     |
|  |                         | 5.5 mA Max.  | 5.8 mA Max.      | 6.7 mA Max.   | 8.1 mA Max.   | $T_{use} = +105 °C$   | No load, $f_o = 170$ MHz                     |                         |  |  |  |  |  |                |          |    |    |    |    |                                    |     |      |      |      |      |     |     |     |     |     |                              |     |      |      |      |      |     |     |     |     |     |      |     |      |      |      |      |     |     |     |     |     |
|  |                         | 4.7 mA Typ.  |                  | 5.7 mA Typ.   | 6.8 mA Typ.   | $T_{use} = +25 °C$  |  |                         |  |  |  |  |  |                |          |    |    |    |    |                                    |     |      |      |      |      |     |     |     |     |     |                              |     |      |      |      |      |     |     |     |     |     |      |     |      |      |      |      |     |     |     |     |     |
| Output disable current                 | $I_{dis}$               | 3.2 mA Max.  | 3.2 mA Max.      | 3.3 mA Max.   | 3.5 mA Max.   | OE = GND, $f_o = 170$ MHz   |  |                         |  |  |  |  |  |                |          |    |    |    |    |                                    |     |      |      |      |      |     |     |     |     |     |                              |     |      |      |      |      |     |     |     |     |     |      |     |      |      |      |      |     |     |     |     |     |
| Standby current                        | $I_{std}$               | 0.9 µA Max.  | 1.0 µA Max.      | 1.5 µA Max.   | 2.5 µA Max.   | $T_{use} = +105 °C$   |  |                         |  |  |  |  |  |                |          |    |    |    |    |                                    |     |      |      |      |      |     |     |     |     |     |                              |     |      |      |      |      |     |     |     |     |     |      |     |      |      |      |      |     |     |     |     |     |
|  |                         | 0.3 µA Typ.  | 0.4 µA Typ.      | 0.5 µA Typ.   | 1.1 µA Typ.   | $T_{use} = +25 °C$  |  |                         |  |  |  |  |  |                |          |    |    |    |    |                                    |     |      |      |      |      |     |     |     |     |     |                              |     |      |      |      |      |     |     |     |     |     |      |     |      |      |      |      |     |     |     |     |     |
| Symmetry                               | SYM                     | 45 % to 55 %   |                  |   |   | 50 % $V_{CC}$ Level   |  |                         |  |  |  |  |  |                |          |    |    |    |    |                                    |     |      |      |      |      |     |     |     |     |     |                              |     |      |      |      |      |     |     |     |     |     |      |     |      |      |      |      |     |     |     |     |     |
| Output voltage<br>(DC characteristics) | $V_{OH}$                | 90 % $V_{CC}$ Min.                                     |                  |   |   | <table border="1"> <thead> <tr> <th colspan="6">IOH/IOL Conditions [mA]</th> </tr> <tr> <th>Rise/Fall time</th> <th><math>V_{CC}</math></th> <th>*A</th> <th>*B</th> <th>*C</th> <th>*D</th> </tr> </thead> <tbody> <tr> <td rowspan="2">Default (<math>f_o &gt; 40</math> MHz),<br/>Fast</td> <td>IOH</td> <td>-2.5</td> <td>-3.5</td> <td>-4.0</td> <td>-5.0</td> </tr> <tr> <td>IOL</td> <td>2.5</td> <td>3.5</td> <td>4.0</td> <td>5.0</td> </tr> <tr> <td rowspan="2">Default (<math>f_o \leq 40</math> MHz)</td> <td>IOH</td> <td>-1.5</td> <td>-2.0</td> <td>-2.5</td> <td>-3.0</td> </tr> <tr> <td>IOL</td> <td>1.5</td> <td>2.0</td> <td>2.5</td> <td>3.0</td> </tr> <tr> <td rowspan="2">Slow</td> <td>IOH</td> <td>-1.0</td> <td>-1.5</td> <td>-2.0</td> <td>-2.5</td> </tr> <tr> <td>IOL</td> <td>1.0</td> <td>1.5</td> <td>2.0</td> <td>2.5</td> </tr> </tbody> </table> |  | IOH/IOL Conditions [mA] |  |  |  |  |  | Rise/Fall time | $V_{CC}$ | *A | *B | *C | *D | Default ( $f_o > 40$ MHz),<br>Fast | IOH | -2.5 | -3.5 | -4.0 | -5.0 | IOL | 2.5 | 3.5 | 4.0 | 5.0 | Default ( $f_o \leq 40$ MHz) | IOH | -1.5 | -2.0 | -2.5 | -3.0 | IOL | 1.5 | 2.0 | 2.5 | 3.0 | Slow | IOH | -1.0 | -1.5 | -2.0 | -2.5 | IOL | 1.0 | 1.5 | 2.0 | 2.5 |
|  | IOH/IOL Conditions [mA] |  |                  |   |   |   |  |                         |  |  |  |  |  |                |          |    |    |    |    |                                    |     |      |      |      |      |     |     |     |     |     |                              |     |      |      |      |      |     |     |     |     |     |      |     |      |      |      |      |     |     |     |     |     |
| Rise/Fall time                         | $V_{CC}$                | *A   | *B               | *C  | *D  |   |  |                         |  |  |  |  |  |                |          |    |    |    |    |                                    |     |      |      |      |      |     |     |     |     |     |                              |     |      |      |      |      |     |     |     |     |     |      |     |      |      |      |      |     |     |     |     |     |
| Default ( $f_o > 40$ MHz),<br>Fast     | IOH                     | -2.5   | -3.5             | -4.0  | -5.0  |   |  |                         |  |  |  |  |  |                |          |    |    |    |    |                                    |     |      |      |      |      |     |     |     |     |     |                              |     |      |      |      |      |     |     |     |     |     |      |     |      |      |      |      |     |     |     |     |     |
|  | IOL                     | 2.5  | 3.5              | 4.0   | 5.0   |   |  |                         |  |  |  |  |  |                |          |    |    |    |    |                                    |     |      |      |      |      |     |     |     |     |     |                              |     |      |      |      |      |     |     |     |     |     |      |     |      |      |      |      |     |     |     |     |     |
| Default ( $f_o \leq 40$ MHz)           | IOH                     | -1.5   | -2.0             | -2.5  | -3.0  |   |  |                         |  |  |  |  |  |                |          |    |    |    |    |                                    |     |      |      |      |      |     |     |     |     |     |                              |     |      |      |      |      |     |     |     |     |     |      |     |      |      |      |      |     |     |     |     |     |
|  | IOL                     | 1.5  | 2.0              | 2.5   | 3.0   |   |  |                         |  |  |  |  |  |                |          |    |    |    |    |                                    |     |      |      |      |      |     |     |     |     |     |                              |     |      |      |      |      |     |     |     |     |     |      |     |      |      |      |      |     |     |     |     |     |
| Slow                                   | IOH                     | -1.0   | -1.5             | -2.0  | -2.5  |   |  |                         |  |  |  |  |  |                |          |    |    |    |    |                                    |     |      |      |      |      |     |     |     |     |     |                              |     |      |      |      |      |     |     |     |     |     |      |     |      |      |      |      |     |     |     |     |     |
|  | IOL                     | 1.0  | 1.5              | 2.0   | 2.5   |   |  |                         |  |  |  |  |  |                |          |    |    |    |    |                                    |     |      |      |      |      |     |     |     |     |     |                              |     |      |      |      |      |     |     |     |     |     |      |     |      |      |      |      |     |     |     |     |     |
| $V_{OL}$                               | 10 % $V_{CC}$ Max.      |  |                  |   | *A: 1.62 V to 1.98 V, *B: 1.98 V to 2.20 V,<br>*C: 2.20 V to 2.80 V, *D: 2.70 V to 3.63 V |   |  |                         |  |  |  |  |  |                |          |    |    |    |    |                                    |     |      |      |      |      |     |     |     |     |     |                              |     |      |      |      |      |     |     |     |     |     |      |     |      |      |      |      |     |     |     |     |     |
| Output load condition                  | $L_{CMOS}$              | 15 pF Max.   |                  |   |   | -   |  |                         |  |  |  |  |  |                |          |    |    |    |    |                                    |     |      |      |      |      |     |     |     |     |     |                              |     |      |      |      |      |     |     |     |     |     |      |     |      |      |      |      |     |     |     |     |     |
| Input voltage                          | $V_{IH}$                | 70 % $V_{CC}$ Min.                                     |                  |   |   | OE or $\overline{ST}$   |  |                         |  |  |  |  |  |                |          |    |    |    |    |                                    |     |      |      |      |      |     |     |     |     |     |                              |     |      |      |      |      |     |     |     |     |     |      |     |      |      |      |      |     |     |     |     |     |
|  | $V_{IL}$                | 30 % $V_{CC}$ Max.                                     |                  |   |   |   |  |                         |  |  |  |  |  |                |          |    |    |    |    |                                    |     |      |      |      |      |     |     |     |     |     |                              |     |      |      |      |      |     |     |     |     |     |      |     |      |      |      |      |     |     |     |     |     |
| Rise and Fall time                     | Default<br>Fast<br>Slow | $t_{r/f}$  | 3.0 ns Max.      |   | $f_o > 40$ MHz  |   | 20 % - 80 % $V_{CC}$ ,<br>$L_{CMOS} = 15$ pF |                         |  |  |  |  |  |                |          |    |    |    |    |                                    |     |      |      |      |      |     |     |     |     |     |                              |     |      |      |      |      |     |     |     |     |     |      |     |      |      |      |      |     |     |     |     |     |
|  |                         |  | 6.0 ns Max.      |   | $f_o \leq 40$ MHz   |   |  |                         |  |  |  |  |  |                |          |    |    |    |    |                                    |     |      |      |      |      |     |     |     |     |     |                              |     |      |      |      |      |     |     |     |     |     |      |     |      |      |      |      |     |     |     |     |     |
|  |                         |  | 3.0 ns Max.      |   | $f_o = 0.67$ MHz to 170 MHz   |   |  |                         |  |  |  |  |  |                |          |    |    |    |    |                                    |     |      |      |      |      |     |     |     |     |     |                              |     |      |      |      |      |     |     |     |     |     |      |     |      |      |      |      |     |     |     |     |     |
|  |                         |  | 10.0 ns Max.     |   | $f_o = 0.67$ MHz to 20 MHz  |   |  |                         |  |  |  |  |  |                |          |    |    |    |    |                                    |     |      |      |      |      |     |     |     |     |     |                              |     |      |      |      |      |     |     |     |     |     |      |     |      |      |      |      |     |     |     |     |     |
| Disable Time                           | $t_{stp}$               | 1 µs Max.  |                  | Measured from the time OE or $\overline{ST}$ pin crosses 30 % $V_{CC}$  |   |   |  |                         |  |  |  |  |  |                |          |    |    |    |    |                                    |     |      |      |      |      |     |     |     |     |     |                              |     |      |      |      |      |     |     |     |     |     |      |     |      |      |      |      |     |     |     |     |     |
| Enable Time                            | $t_{sta}$               | 1 µs Max.  |                  | Measured from the time OE pin crosses 70 % $V_{CC}$                     |   |   |  |                         |  |  |  |  |  |                |          |    |    |    |    |                                    |     |      |      |      |      |     |     |     |     |     |                              |     |      |      |      |      |     |     |     |     |     |      |     |      |      |      |      |     |     |     |     |     |
| Resume Time                            | $t_{res}$               | 3 ms Max.  |                  | Measured from the time $\overline{ST}$ pin crosses 70 % $V_{CC}$        |   |   |  |                         |  |  |  |  |  |                |          |    |    |    |    |                                    |     |      |      |      |      |     |     |     |     |     |                              |     |      |      |      |      |     |     |     |     |     |      |     |      |      |      |      |     |     |     |     |     |
| Start-up time                          | $t_{str}$               | 3 ms Max.  |                  | Measured from the time $V_{CC}$ reaches its rated minimum value, 1.62 V |   |   |  |                         |  |  |  |  |  |                |          |    |    |    |    |                                    |     |      |      |      |      |     |     |     |     |     |                              |     |      |      |      |      |     |     |     |     |     |      |     |      |      |      |      |     |     |     |     |     |
| Frequency aging                        | $f_{aging}$             | This is included in frequency tolerance specification. |                  |   |   | +25 °C, first year  |  |                         |  |  |  |  |  |                |          |    |    |    |    |                                    |     |      |      |      |      |     |     |     |     |     |                              |     |      |      |      |      |     |     |     |     |     |      |     |      |      |      |      |     |     |     |     |     |

\*1 Frequency tolerance includes initial frequency tolerance, temperature variation, supply voltage variation, reflow drift, load drift and aging (+25 °C, 1 year).

**Pin description**

| Pin | Name            | I/O type | Function      |   |
|-----|-----------------|----------|---------------|---|
| 1   | OE              | Input    | Output enable | High: Specified frequency output from OUT pin<br>Low: Out pin is low (weak pull down), only output driver is disabled.  |
|     | $\overline{ST}$ | Input    | Standby       | High: Specified frequency output from OUT pin<br>Low: Out pin is low (weak pull down),<br>Device goes to standby mode. Supply current reduces to the least as $I_{std}$ . |
| 2   | GND             | Power    | Ground        |   |
| 3   | OUT             | Output   | Clock output  |   |
| 4   | $V_{CC}$        | Power    | Power supply  |   |

Product Name

SG-8101CG 170.000000MHz T C H P A

① ② ③ ④ ⑤ ⑥ ⑦ ⑧

- ① Model, ② Package type,
- ③ Frequency, ④ Supply voltage,
- ⑤ Frequency tolerance, ⑥ Operating temperature,
- ⑦ Function, ⑧ Rise/Fall time

|                     |
|---------------------|
| ② Package type      |
| CA: 7.0 mm x 5.0 mm |
| CB: 5.0 mm x 3.2 mm |
| CE: 3.2 mm x 2.5 mm |
| CG: 2.5 mm x 2.0 mm |

|                        |
|------------------------|
| ④ Supply voltage       |
| T: 1.8 V to 3.3 V Typ. |

|                         |
|-------------------------|
| ⑥ Operating temperature |
| G: -40 °C to +85 °C     |
| H: -40 °C to +105 °C    |

|                  |
|------------------|
| ⑧ Rise/Fall time |
| A: Default       |
| B: Fast          |
| C: Slow          |

|                        |
|------------------------|
| ⑤ Frequency tolerance  |
| B: $15 \times 10^{-6}$ |
| C: $20 \times 10^{-6}$ |
| J: $50 \times 10^{-6}$ |

|                  |
|------------------|
| ⑦ Function       |
| P: Output Enable |
| S: Standby       |

| Available combination |                      | CA: 7.0 mm x 5.0 mm    |                        |                        | CB: 5.0 mm x 3.2 mm    |                        |                        | CE: 3.2 mm x 2.5 mm    |                        |                        | CG: 2.5 mm x 2.0 mm    |                        |                        |
|-----------------------|----------------------|------------------------|------------------------|------------------------|------------------------|------------------------|------------------------|------------------------|------------------------|------------------------|------------------------|------------------------|------------------------|
| Frequency tolerance   |                      | B: $15 \times 10^{-6}$ | C: $20 \times 10^{-6}$ | J: $50 \times 10^{-6}$ | B: $15 \times 10^{-6}$ | C: $20 \times 10^{-6}$ | J: $50 \times 10^{-6}$ | B: $15 \times 10^{-6}$ | C: $20 \times 10^{-6}$ | J: $50 \times 10^{-6}$ | B: $15 \times 10^{-6}$ | C: $20 \times 10^{-6}$ | J: $50 \times 10^{-6}$ |
| Operating temperature | G: -40 °C to +85 °C  | ✓                      |                        |                        | ✓                      |                        |                        | ✓                      |                        |                        | ✓                      |                        |                        |
|                       | H: -40 °C to +105 °C |                        | ✓                      | ✓                      |                        | ✓                      | ✓                      |                        | ✓                      | ✓                      |                        | ✓                      | ✓                      |

External dimensions

(Unit: mm)

SG-8101CG

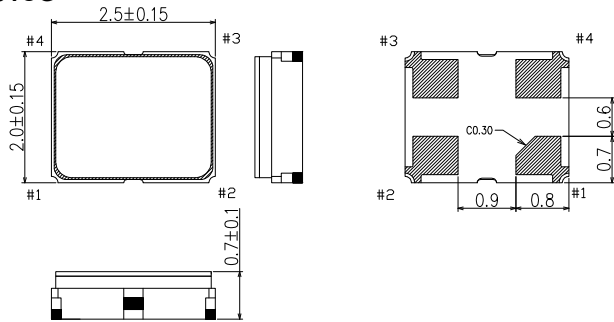

SG-8101CE

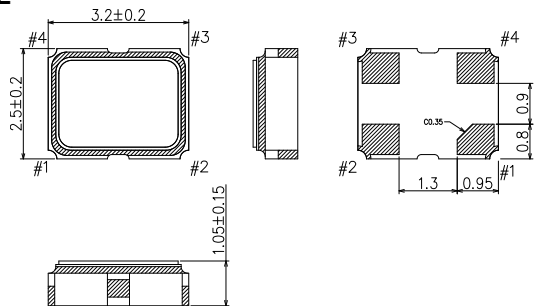

SG-8101CB

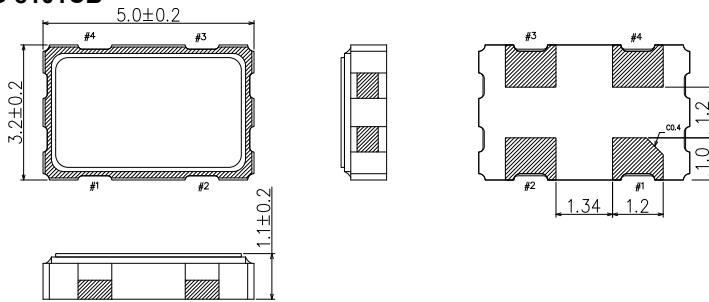

SG-8101CA

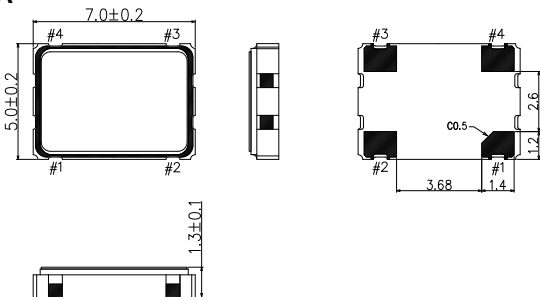

Footprint (Recommended)

(Unit: mm)

SG-8101CG

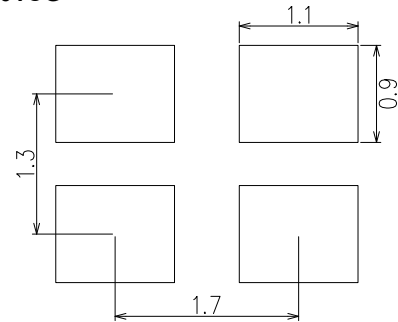

SG-8101CE

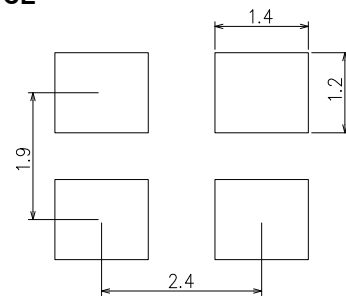

SG-8101CB

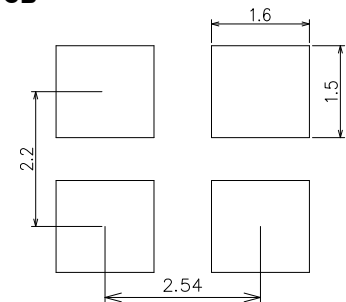

SG-8101CA

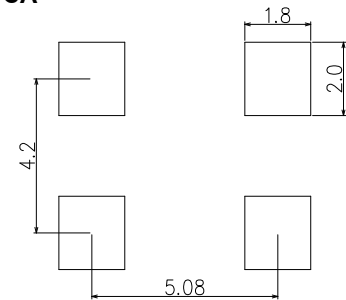

Notes:

In order to achieve optimum jitter performance, the 0.1 μF capacitor between V<sub>CC</sub> and GND should be placed. It is also recommended that the capacitors are placed on the device side of the PCB, as close to the device as possible and connected together with short wiring pattern.



Specification Graph (Typical supplemental specification. Unless otherwise specified  $T_{use} = 25\text{ }^{\circ}\text{C}$ ,  $L_{CMOS} = 15\text{ pF}$ )

Current Consumption

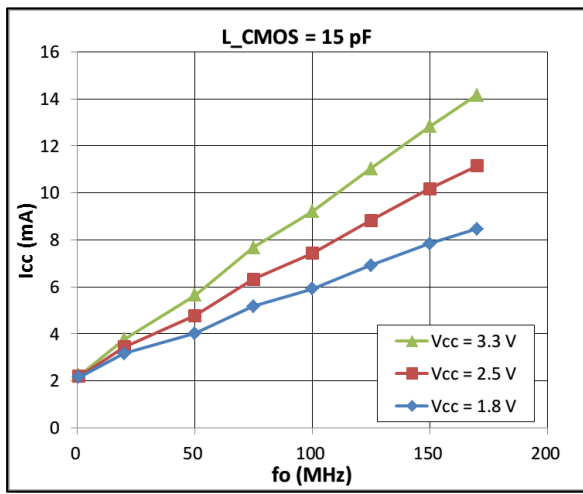
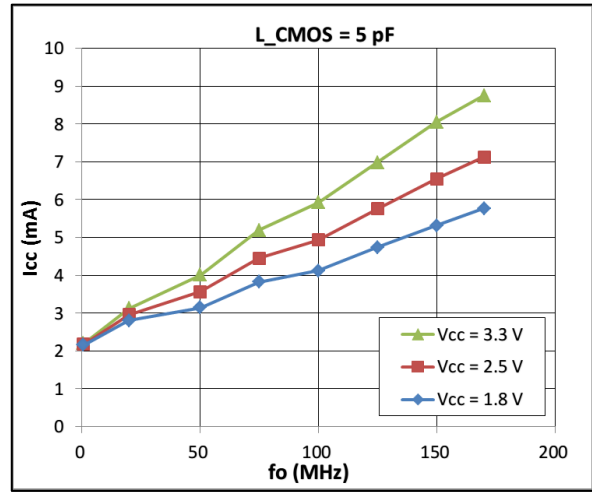
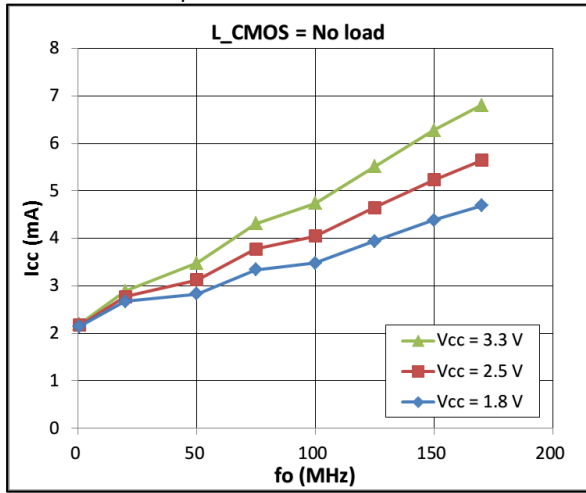

Output disable current

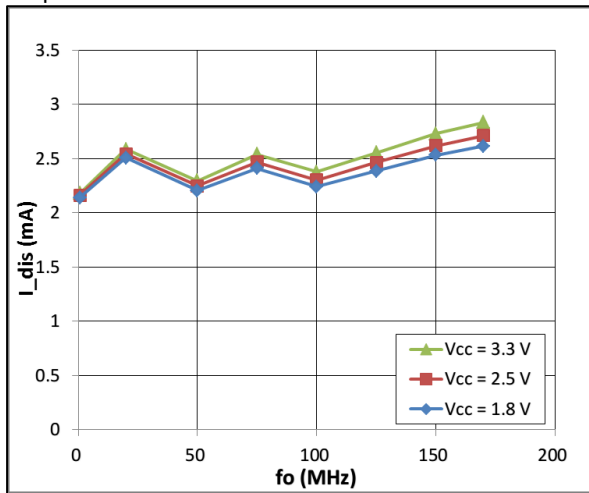

Standby current

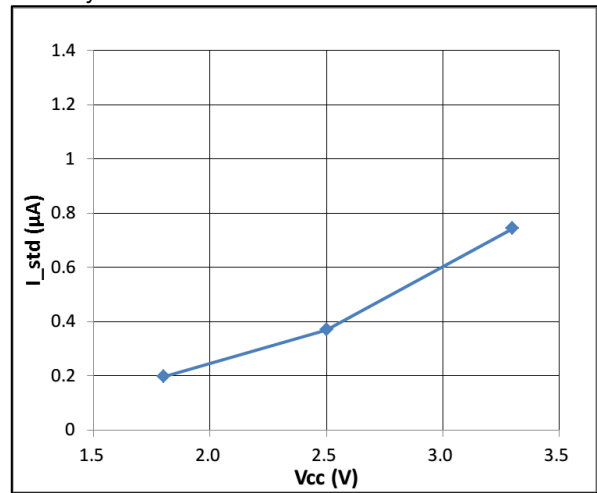

Notes:





Specification Graph (Typical supplemental specification. Unless otherwise specified  $T_{use} = 25\text{ }^\circ\text{C}$ ,  $L_{CMOS} = 15\text{ pF}$ )

Phase Jitter RMS

(Integration bandwidth 12 k to 20 MHz)



Phase Jitter RMS

(Integration bandwidth 1.8 M to 20 MHz)



Period Jitter RMS

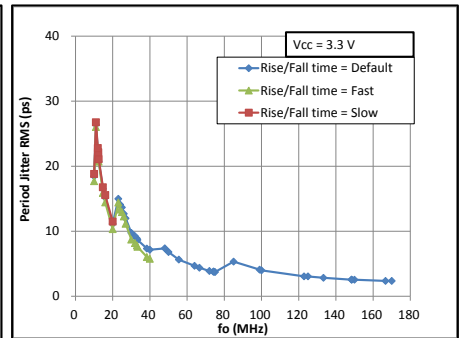
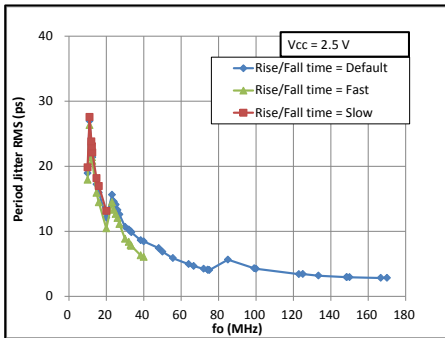

Period Jitter Peak-Peak

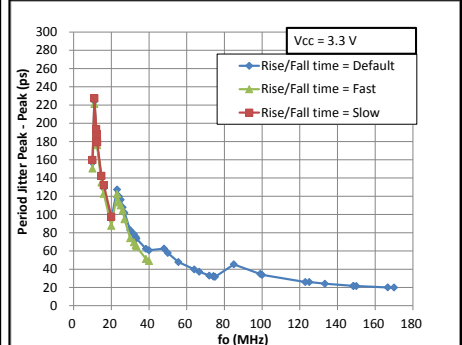
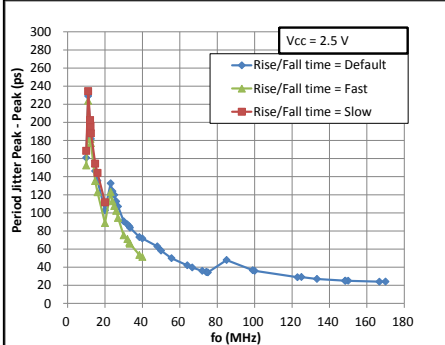
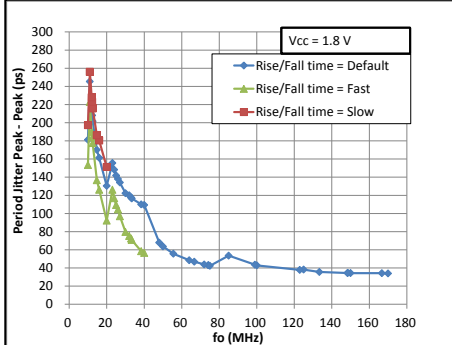

Cycle-to-Cycle Jitter Peak-Peak

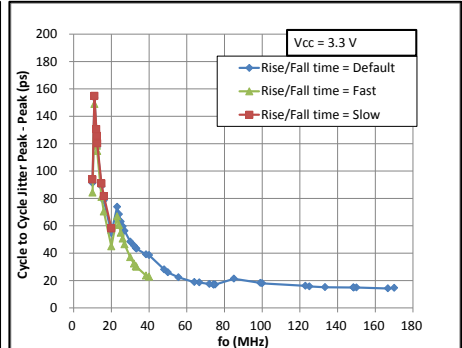
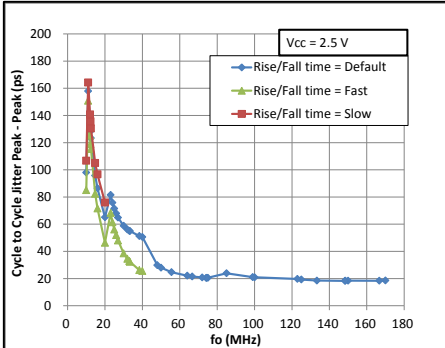
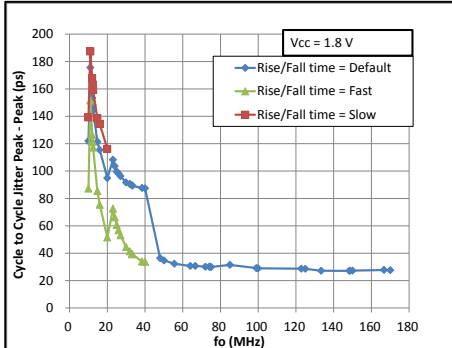

■ Notes:

Blank area for notes.

Specification Graph

(Typical supplemental specification. Unless otherwise specified  $T_{use} = 25\text{ }^{\circ}\text{C}$ ,  $L_{CMOS} = 15\text{ pF}$ ,  $V_{CC} = 3.3\text{ V}$ )

Rise/Fall Time ( $f_o = 20\text{ MHz}$ )

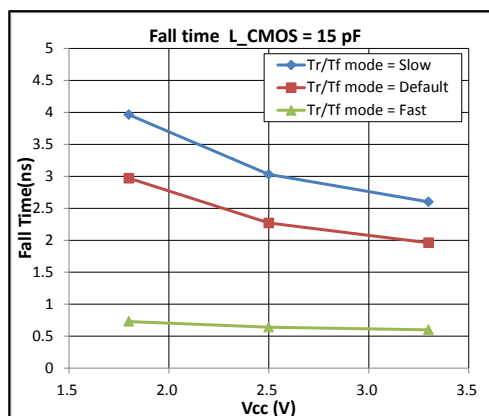
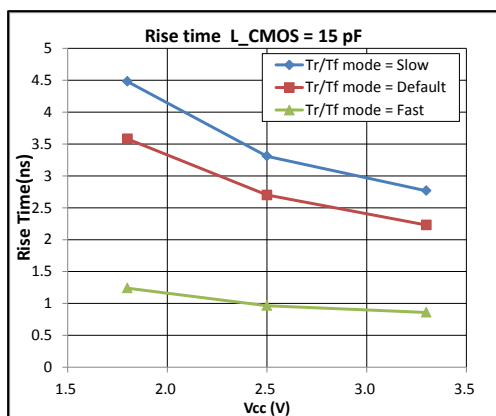
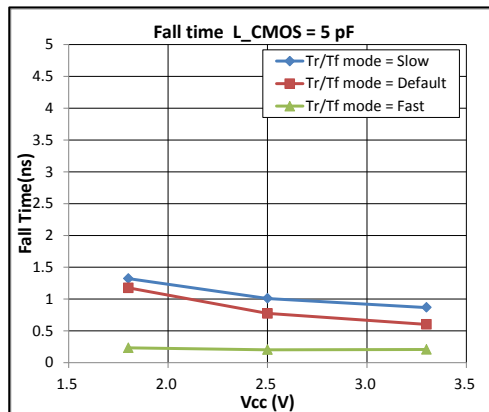
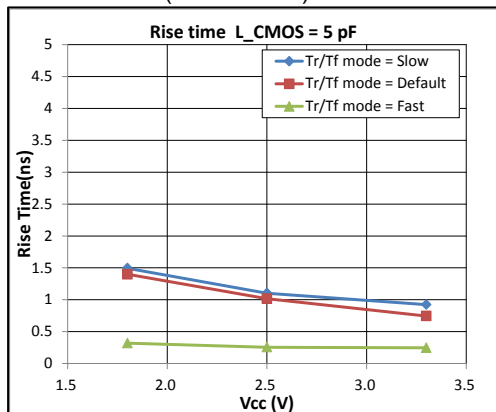

Harmonics spectrum ( $f_o = 20\text{ MHz}$ )

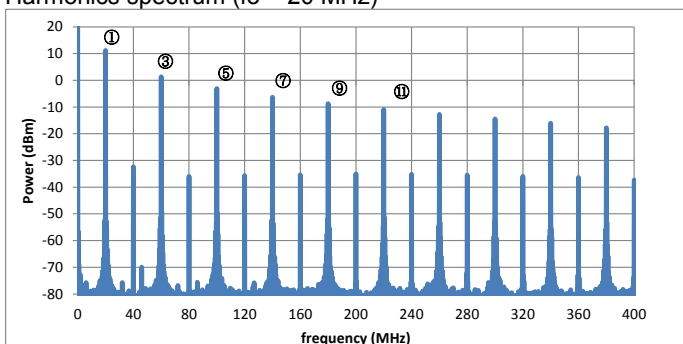

Harmonics comparison

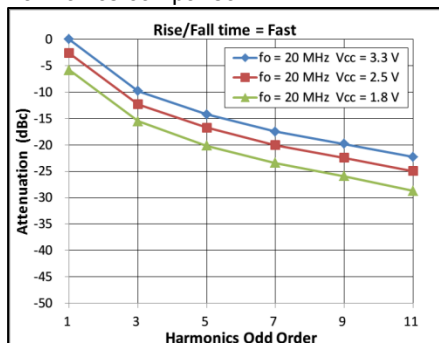

Normalize to  $V_{CC} = 3.3\text{ V}$ .

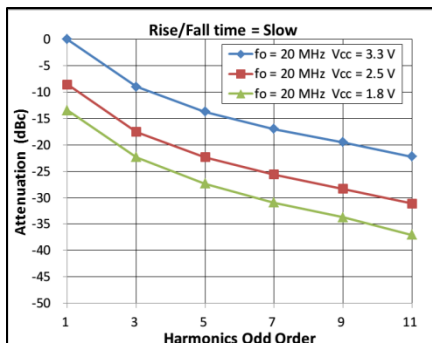

Normalize to  $V_{CC} = 3.3\text{ V}$ .

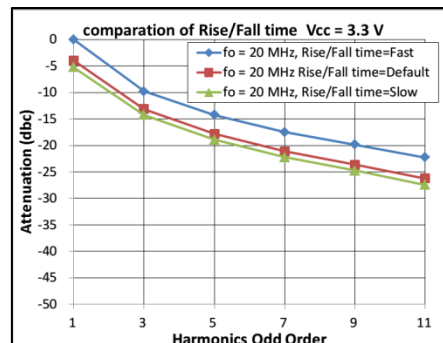

Normalize to Rise/Fall time = "Fast".

Notes:

| frequency       | slow     | default     | fast     |
|-----------------|----------|-------------|----------|
| 0.67 M – 20 MHz | See Slow | See Default | See Fast |
| 20 M – 40 MHz   | -        | See Default | See Fast |
| 40 M – 170 MHz  | -        | See Fast    | See Fast |



ESD Rating

| Test items                 | Breakdown voltage |
|----------------------------|-------------------|
| Human Body Model (HBM)     | 2000 V            |
| Machine Model (MM)         | 250 V             |
| Charged Device Model (CDM) | 750 V             |

Device Marking (Standard specification)

| Model     | Factory Programmed Part Marking | Field Programmable Part Marking (Blank Samples) |
|-----------|---------------------------------|---|
| SG-8101CG |                                 |   |
| SG-8101CE |                                 |   |
| SG-8101CB |                                 |   |
| SG-8101CA |                                 |   |

Simulation Model

- IBIS Model is available upon request. Please contact us.  
Information Required: Oscillator operating condition (i.e. Power Supply, Rise/Fall Time, Temperature)



Device Material & Environmental Information

| Model     | Package Dimensions | # of Pins | Reference Weight (Typ.) | Terminal Material | Terminal Plating | Complies With EU RoHS | Pb Free | MSL Rating | Peak Temp. (Max) |
|-----------|--------------------|-----------|-------------------------|-------------------|------------------|-----------------------|---------|------------|------------------|
| SG-8101CG | 2.5 x 2.0 x 0.7 mm | 4         | 13 mg                   | W                 | Au               | Yes                   | Yes     | 1          | 260 °C           |
| SG-8101CE | 3.2 x 2.5 x 1.0 mm | 4         | 25 mg                   | W                 | Au               | Yes                   | Yes     | 1          | 260 °C           |
| SG-8101CB | 5.0 x 3.2 x 1.1 mm | 4         | 51 mg                   | W                 | Au               | Yes                   | Yes     | 1          | 260 °C           |
| SG-8101CA | 7.0 x 5.0 x 1.3 mm | 4         | 143 mg                  | W                 | Au               | Yes                   | Yes     | 1          | 260 °C           |

SMD products Reflow profile(example)

The availability of the heat resistance for reflow conditions of JEDEC-STD-020D.01 is judged individually. Please inquire.



|  |  |
|--|--|
|  | <ul style="list-style-type: none"> <li>Pb free.</li> </ul>   |
|  | <ul style="list-style-type: none"> <li>Complies with EU RoHS directive.                     <ul style="list-style-type: none"> <li>About the products without the Pb-free mark. Contains Pb in products exempted by EU RoHS directive. (Contains Pb in sealing glass, high melting temperature type solder or other.)</li> </ul> </li> </ul> |

Standard Packing Specification

SMD products are packed in the shipping carton as below table in accordance with taping standards EIA-481 and IEC-60286

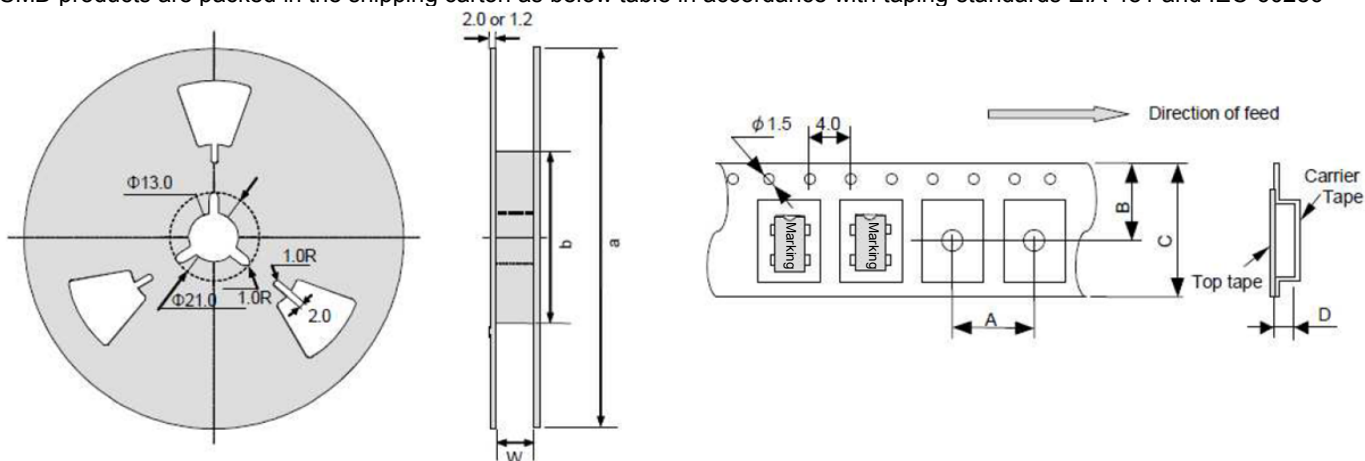

Standard Packing Quantity & Dimension(Unit mm)

| Model     | Quantity (pcs/Reel) | Reel Dimension |      |      | Career Tape Dimension |      |    |      | Direction of Feed (L= Left Direction) |
|-----------|---------------------|----------------|------|------|-----------------------|------|----|------|---------------------------------------|
|           |                     | a              | b    | W    | A                     | B    | C  | D    |                                       |
| SG-8101CG | 3000                | Φ180           | Φ60  | 9    | 4                     | 5.25 | 8  | 1.15 | L                                     |
| SG-8101CE | 2000                | Φ180           | Φ60  | 9    | 4                     | 5.25 | 8  | 1.4  | L                                     |
| SG-8101CB | 1000                | Φ180           | Φ60  | 13   | 8                     | 7.25 | 12 | 1.4  | L                                     |
| SG-8101CA | 1000                | Φ254           | Φ100 | 17.5 | 8                     | 9.25 | 16 | 2.3  | L                                     |

## PROMOTION OF ENVIRONMENTAL MANAGEMENT SYSTEM CONFORMING TO INTERNATIONAL STANDARDS

At Seiko Epson, all environmental initiatives operate under the Plan-Do-Check-Action (PDCA) cycle designed to achieve continuous improvements. The environmental management system (EMS) operates under the ISO 14001 environmental management standard.

All of our major manufacturing and non-manufacturing sites, in Japan and overseas, completed the acquisition of ISO 14001 certification.

ISO 14000 is an international standard for environmental management that was established by the International Standards Organization in 1996 against the background of growing concern regarding global warming, destruction of the ozone layer, and global deforestation.

## WORKING FOR HIGH QUALITY

In order provide high quality and reliable products and services than meet customer needs,

Seiko Epson made early efforts towards obtaining ISO9000 series certification and has acquired ISO9001 for all business establishments in Japan and abroad. We have also acquired ISO/TS 16949 certification that is requested strongly by major automotive manufacturers as standard.

ISO/TS16949 is the international standard that added the sector-specific supplemental requirements for automotive industry based on ISO9001.

### ► Explanation of the mark that are using it for the catalog

|   |   |
|---|---|
|  | ► Pb free.  |
|  | ► Complies with EU RoHS directive.<br>*About the products without the Pb-free mark.<br>Contains Pb in products exempted by EU RoHS directive.<br>(Contains Pb in sealing glass, high melting temperature type solder or other.) |
|  | ► Designed for automotive applications such as Car Multimedia, Body Electronics, Remote Keyless Entry etc.  |
|  | ► Designed for automotive applications related to driving safety (Engine Control Unit, Air Bag, ESC etc ).  |

## Notice

- This material is subject to change without notice.
- Any part of this material may not be reproduced or duplicated in any form or any means without the written permission of Seiko Epson.
- The information about applied data, circuitry, software, usage, etc. written in this material is intended for reference only. Seiko Epson does not assume any liability for the occurrence of customer damage or infringing on any patent or copyright of a third party. This material does not authorize the licensing for any patent or intellectual copyrights.
- When exporting the products or technology described in this material, you should comply with the applicable export control laws and regulations and follow the procedures required by such laws and regulations.
- You are requested not to use the products (and any technical information furnished, if any) for the development and/or manufacture of weapon of mass destruction or for other military purposes. You are also requested that you would not make the products available to any third party who may use the products for such prohibited purposes.
- These products are intended for general use in electronic equipment. When using them in specific applications that require extremely high reliability, such as the applications stated below, you must obtain permission from Seiko Epson in advance.  
/ Space equipment (artificial satellites, rockets, etc.) / Transportation vehicles and related (automobiles, aircraft, trains, vessels, etc.) / Medical instruments to sustain life / Submarine transmitters / Power stations and related / Fire work equipment and security equipment / traffic control equipment / and others requiring equivalent reliability.
- All brands or product names mentioned herein are trademarks and/or registered trademarks of their respective.