

## N-channel Enhanced mode TO-251N/S/U/TO-252/TO-220F /TO-251/TO-251NX/TO-220/TO-251Q /TO-251MQ MOSFET

### Features

- High ruggedness
- Low  $R_{DS(ON)}$  (Typ 1.7 $\Omega$ ) @  $V_{GS}=10V$
- Low Gate Charge (Typ 26nC)
- Improved dv/dt Capability
- 100% Avalanche Tested
- Application: TV-Power , LED , Charge

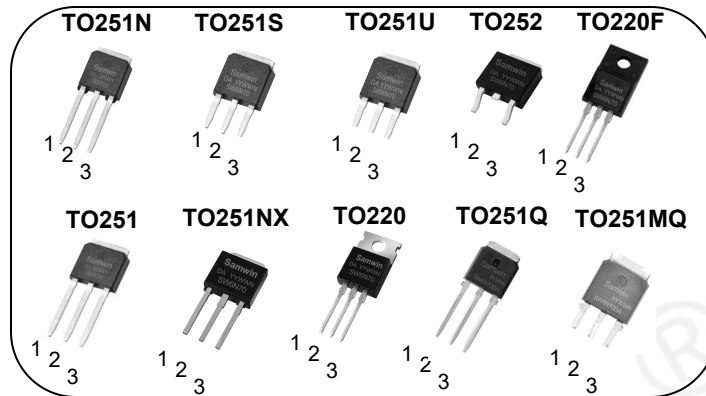

1. Gate 2. Drain 3. Source

$BV_{DSS}$  : 700V

$I_D$  : 6A

$R_{DS(ON)}$  : 1.7 $\Omega$

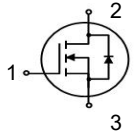

### General Description

This power MOSFET is produced with advanced technology of SAMWIN.

This technology enable the power MOSFET to have better characteristics, including fast switching time, low on resistance, low gate charge and especially excellent avalanche characteristics.

### Order Codes

Item	Sales Type	Marking	Package	Packaging
1	SW N 6N70DA	SW6N70DA	TO-251N	TUBE
2	SW SI 6N70DA	SW6N70DA	TO-251S	TUBE
3	SW UI 6N70DA	SW6N70DA	TO-251U	TUBE
4	SW D 6N70DA	SW6N70DA	TO-252	REEL
5	SW F 6N70DA	SW6N70DA	TO-220F	TUBE
6	SW I 6N70DA	SW6N70DA	TO-251	TUBE
7	SWNX 6N70DA	SW6N70DA	TO-251NX	TUBE
8	SW P 6N70DA	SW6N70DA	TO-220	TUBE
9	SW QI 6N70DA	SW6N70DA	TO-251Q	TUBE
10	SW MQI 6N70DA	SW6N70DA	TO-251MQ	TUBE

### Absolute maximum ratings

Symbol	Parameter	Value							Unit
		TO251S/ TO251U	TO252	TO220F	TO251/T O251N	TO251 NX	TO220	TO-251Q/TO- 251MQ	
$V_{DSS}$	Drain to source voltage	700							V
$I_D$	Continuous drain current (@ $T_C=25^\circ C$ )	6*							A
	Continuous drain current (@ $T_C=100^\circ C$ )	3.8*							A
$I_{DM}$	Drain current pulsed (note 1)	24							A
$V_{GS}$	Gate to source voltage	$\pm 30$							V
$E_{AS}$	Single pulsed avalanche energy (note 2)	216							mJ
$E_{AR}$	Repetitive avalanche energy (note 1)	20							mJ
dv/dt	Peak diode recovery dv/dt (note 3)	5							V/ns
$P_D$	Total power dissipation (@ $T_C=25^\circ C$ )	138.8	195.3	21.9	138.8	147	186.6	138.8	W
	Derating factor above 25 $^\circ C$	1.11	1.56	0.18	1.11	1.18	1.49	1.11	W/ $^\circ C$
$T_{STG}, T_J$	Operating junction temperature & storage temperature	-55 ~ + 150							$^\circ C$
$T_L$	Maximum lead temperature for soldering purpose, 1/8 from case for 5 seconds.	300							$^\circ C$

\*. Drain current is limited by junction temperature.

## Thermal characteristics

Symbol	Parameter	Value							Unit
		TO251S/ TO251U	TO252	TO220F	TO251/TO 251N	TO251 NX	TO220	TO-251Q/TO-25 1MQ	
$R_{thjc}$	Thermal resistance, Junction to case	0.9	0.64	5.7	0.9	0.85	0.67	0.9	°C/W
$R_{thja}$	Thermal resistance, Junction to ambient	80		46.9	80	100	59.2	80	°C/W

## Electrical characteristic ( $T_C = 25^\circ\text{C}$ unless otherwise specified )

Symbol	Parameter	Test conditions	Min.	Typ.	Max.	Unit
<b>Off characteristics</b>						
$BV_{DSS}$	Drain to source breakdown voltage	$V_{GS}=0V, I_D=250\mu A$	700			V
$\Delta BV_{DSS} / \Delta T_J$	Breakdown voltage temperature coefficient	$I_D=250\mu A$ , referenced to $25^\circ\text{C}$		0.42		V/°C
$I_{DSS}$	Drain to source leakage current	$V_{DS}=700V, V_{GS}=0V$			1	$\mu A$
		$V_{DS}=560V, T_C=125^\circ\text{C}$			50	$\mu A$
$I_{GSS}$	Gate to source leakage current, forward	$V_{GS}=30V, V_{DS}=0V$			100	nA
	Gate to source leakage current, reverse	$V_{GS}=-30V, V_{DS}=0V$			-100	nA
<b>On characteristics</b>						
$V_{GS(TH)}$	Gate threshold voltage	$V_{DS}=V_{GS}, I_D=250\mu A$	2.5		4.5	V
$R_{DS(ON)}$	Drain to source on state resistance	$V_{GS}=10V, I_D=3A$		1.7	1.9	$\Omega$
$G_{fs}$	Forward transconductance	$V_{DS}=30V, I_D=3A$		5		S
<b>Dynamic characteristics</b>						
$C_{iss}$	Input capacitance	$V_{GS}=0V, V_{DS}=25V, f=1\text{MHz}$		1040		pF
$C_{oss}$	Output capacitance			88		
$C_{riss}$	Reverse transfer capacitance			18		
$t_{d(on)}$	Turn on delay time	$V_{DS}=350V, I_D=6A, R_G=25\Omega, V_{GS}=10V$ (note 4,5)		21		ns
$t_r$	Rising time			34		
$t_{d(off)}$	Turn off delay time			65		
$t_f$	Fall time			33		
$Q_g$	Total gate charge	$V_{DS}=560V, V_{GS}=10V, I_D=6A$ (note 4,5)		26		nC
$Q_{gs}$	Gate-source charge			5.5		
$Q_{gd}$	Gate-drain charge			11		
$R_g$	Gate resistance	$V_{DS}=0V$ , Scan F mode		2.5		$\Omega$

## Source to drain diode ratings characteristics

Symbol	Parameter	Test conditions	Min.	Typ.	Max.	Unit
$I_S$	Continuous source current	Integral reverse p-n Junction diode in the MOSFET			6	A
$I_{SM}$	Pulsed source current				24	A
$V_{SD}$	Diode forward voltage drop.	$I_S=6A, V_{GS}=0V$			1.4	V
$t_{rr}$	Reverse recovery time	$I_S=6A, V_{GS}=0V,$ $di_f/dt=100A/\mu s$		315		ns
$Q_{rr}$	Reverse recovery charge			2.95		$\mu C$

### ※. Notes

1. Repeattive rating : pulse width limited by junction temperature.
2.  $L = 12\text{mH}, I_{AS} = 6A, V_{DD} = 100V, R_G = 25\Omega$ , Starting  $T_J = 25^\circ\text{C}$
3.  $I_{SD} \leq 6A, di/dt = 100A/\mu s, V_{DD} \leq BV_{DSS}$ , Starting  $T_J = 25^\circ\text{C}$
4. Pulse Test : Pulse Width  $\leq 300\mu s$ , duty cycle  $\leq 2\%$
5. Essentially independent of operating temperature.

**Fig. 1. On-state characteristics**

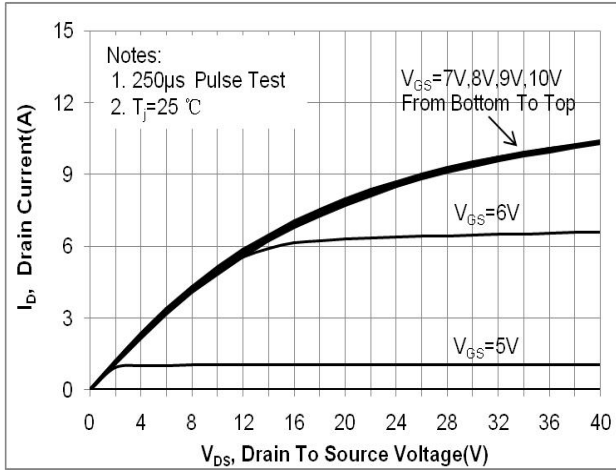

**Fig. 2. Transfer Characteristics**

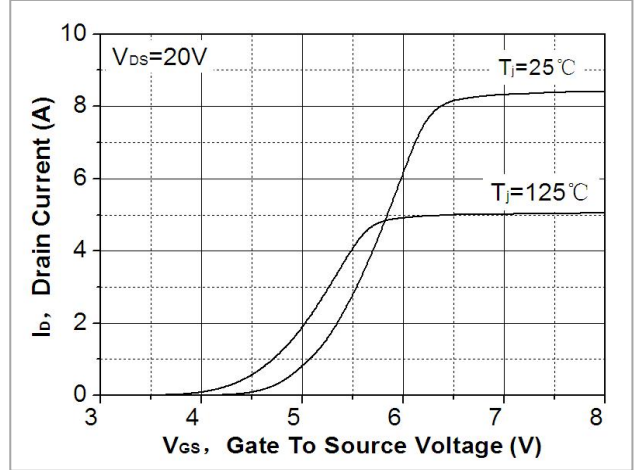

**Fig. 3. On-resistance variation vs. drain current and gate voltage**

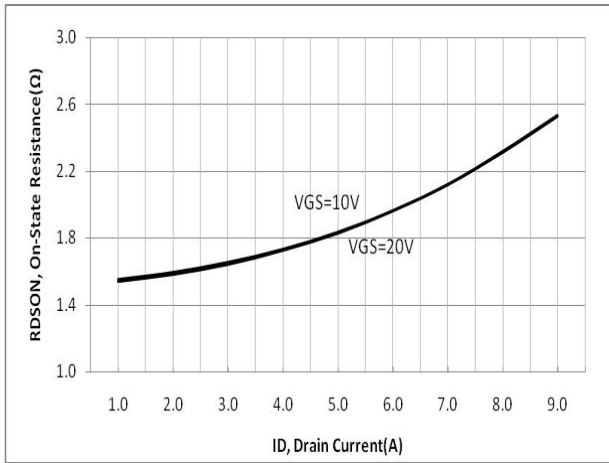

**Fig. 4. On state current vs. diode forward voltage**

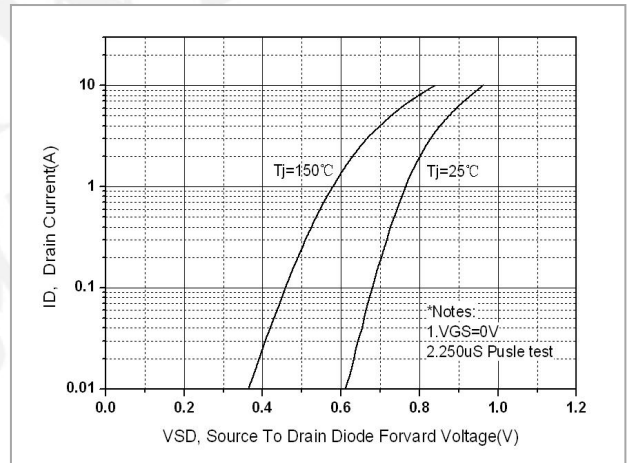

**Fig 5. Breakdown Voltage Variation vs. Junction Temperature**

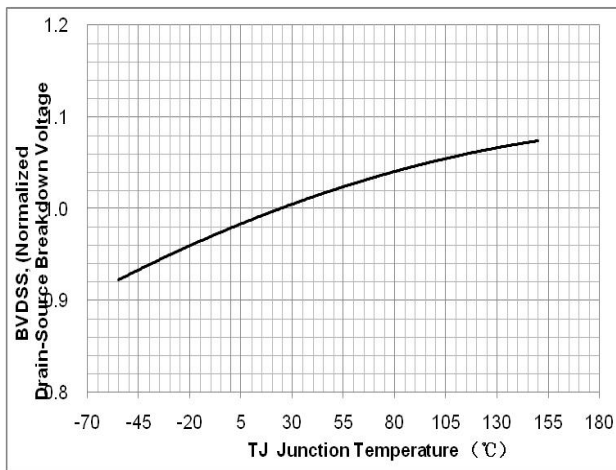

**Fig. 6. On resistance variation vs. junction temperature**

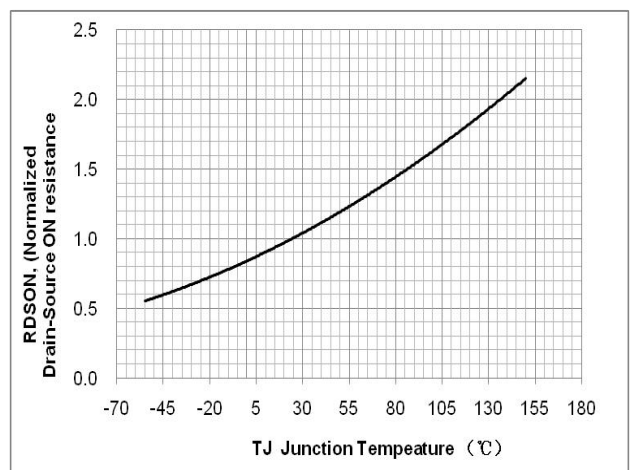

Fig. 7. Gate charge characteristics

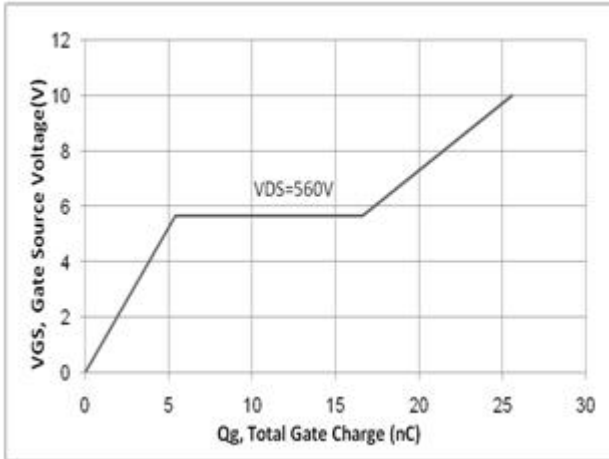

Fig. 8. Capacitance Characteristics

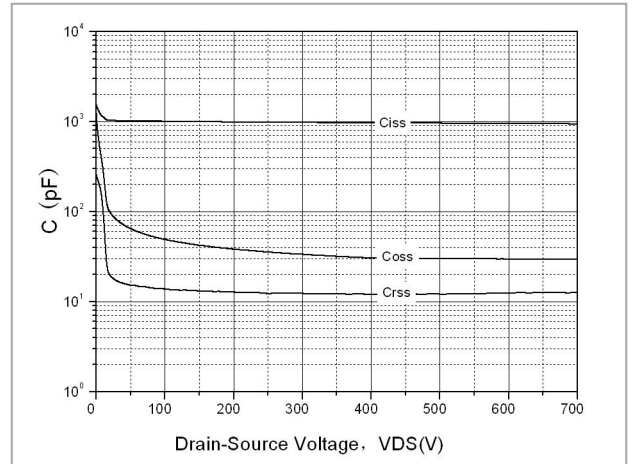

Fig. 9. Maximum safe operating area (TO-251S&TO-251U)

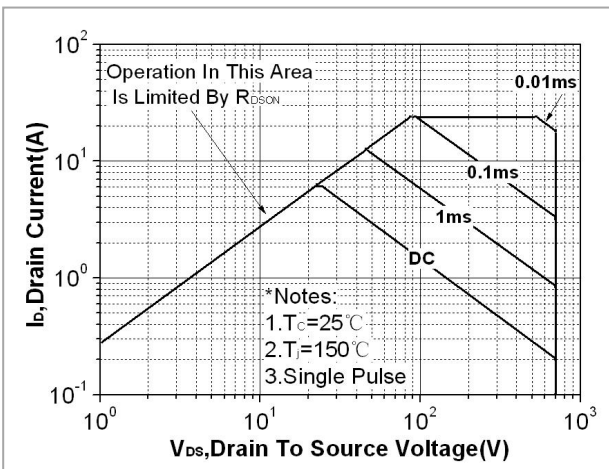

Fig.10. Maximum safe operating area(TO-252)

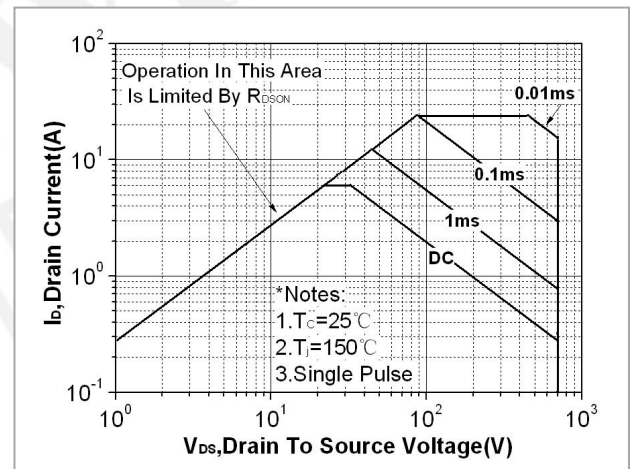

Fig. 11. Maximum safe operating area(TO-220F)

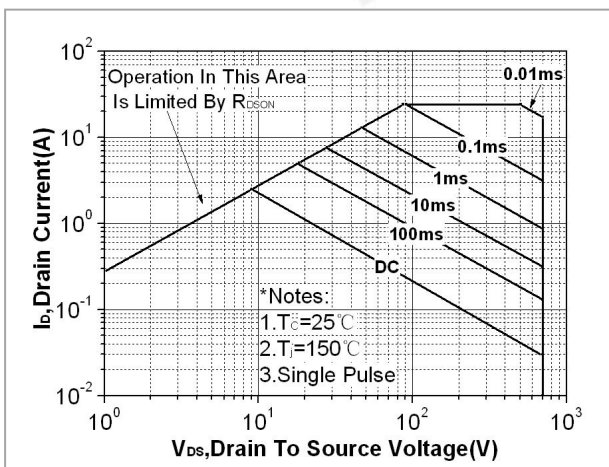

Fig. 12. Maximum safe operating area(TO-251&TO-251N)

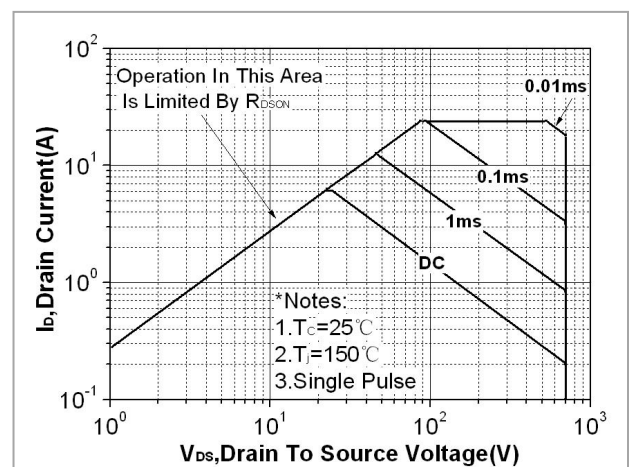

Fig. 13. Maximum safe operating area(TO-251NX)

Fig. 14. Maximum safe operating area(TO-220)

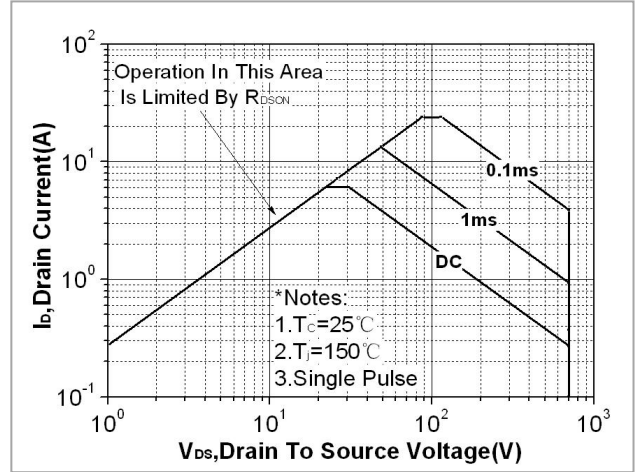
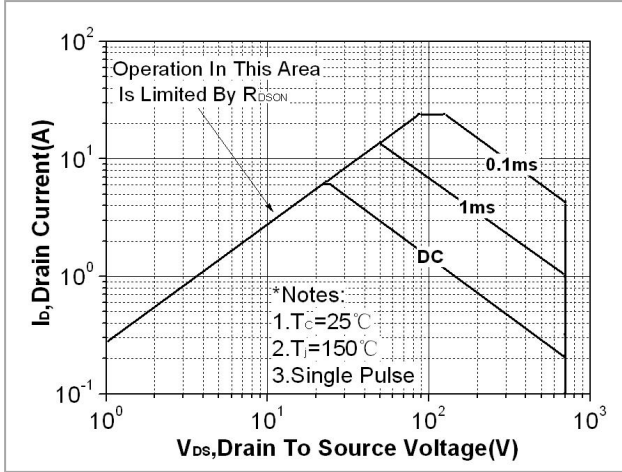

Fig. 15. Maximum safe operating area(TO-251Q&TO-251MQ)

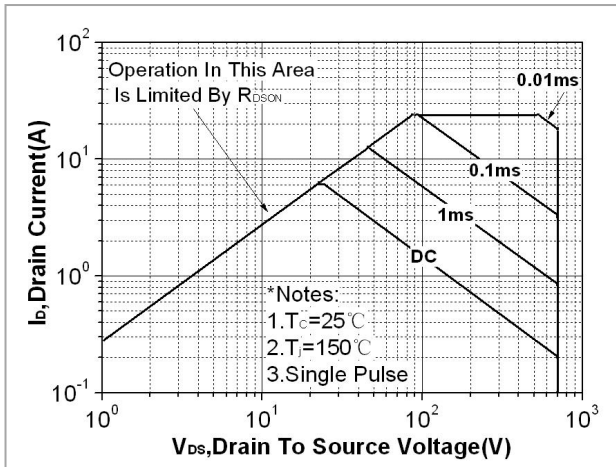

Fig. 16. Transient thermal response curve(TO-251S&TO-251U)

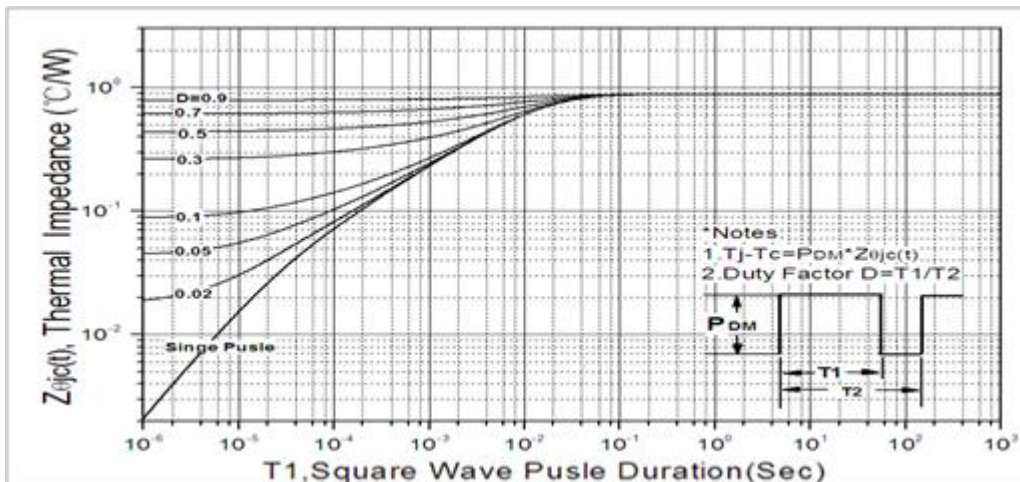



Fig. 17. Transient thermal response curve(TO-252)

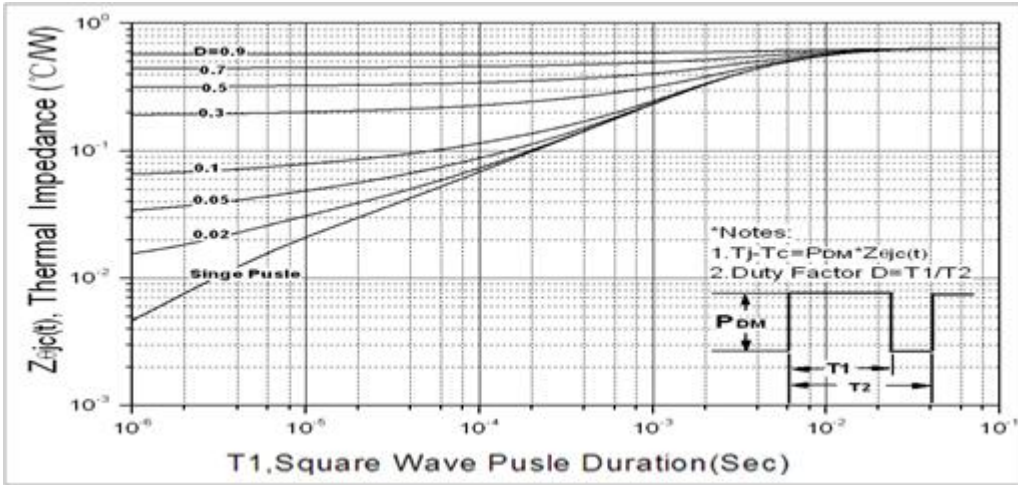

Fig. 18. Transient thermal response curve(TO-220F)

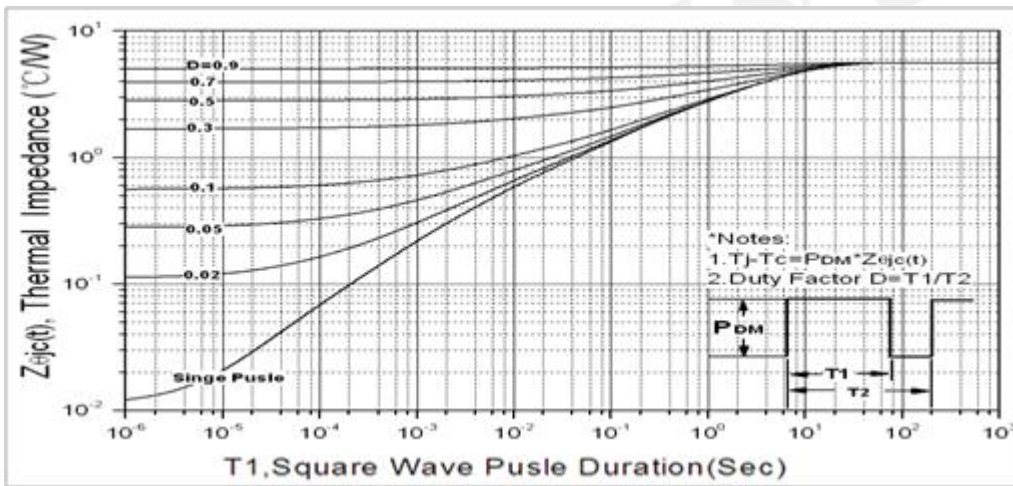

Fig. 19. Transient thermal response curve(TO-251&TO-251N)

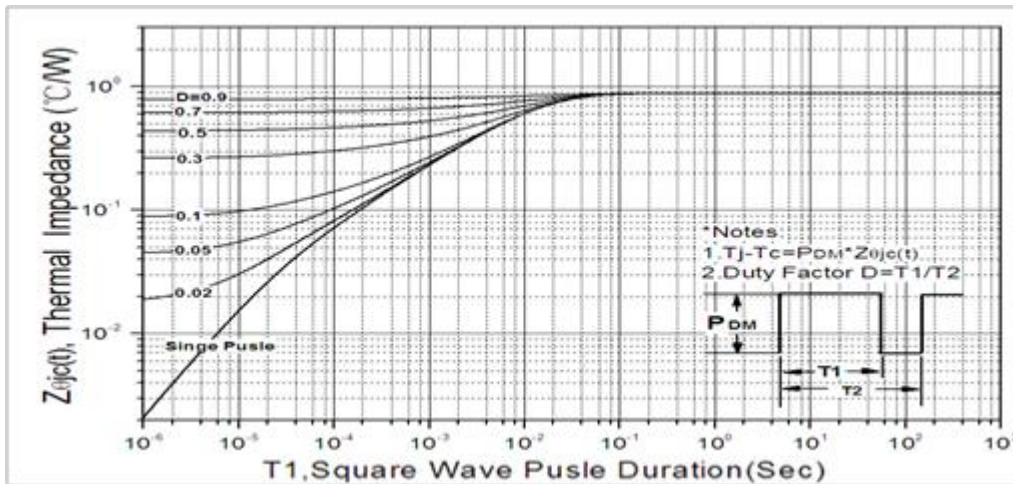

Fig. 20 Transient thermal response curve(TO-251NX)

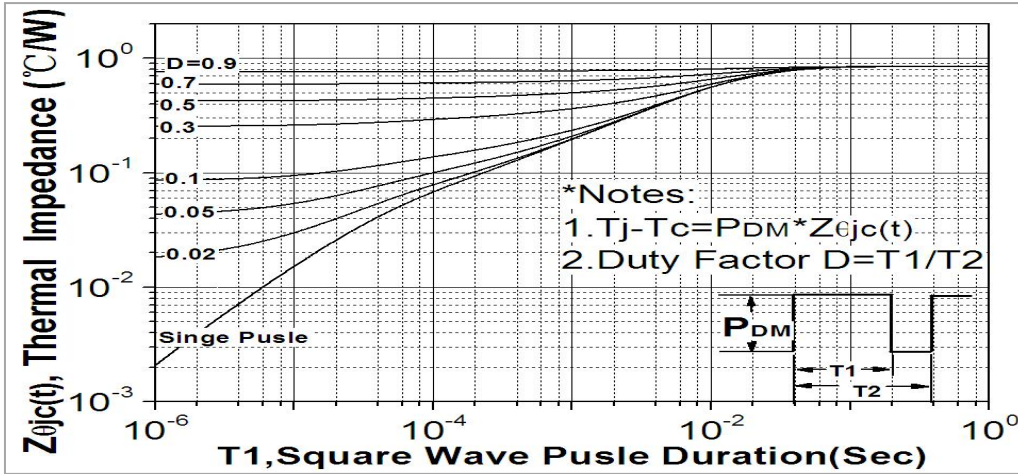

Fig. 21. Transient thermal response curve(TO-220)

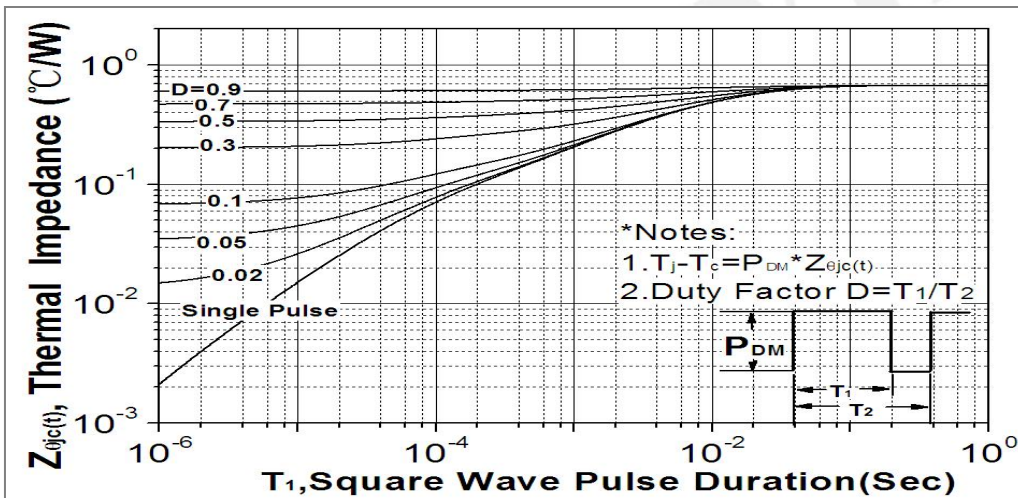
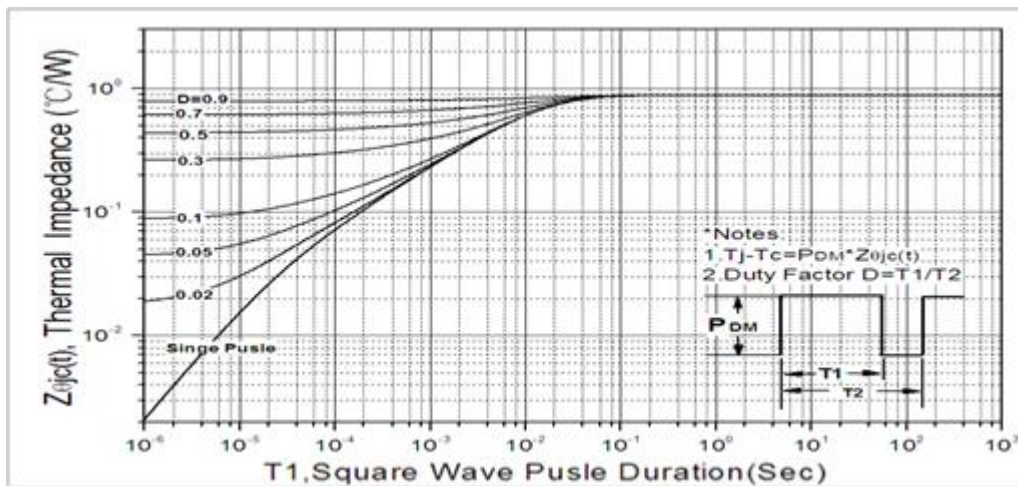
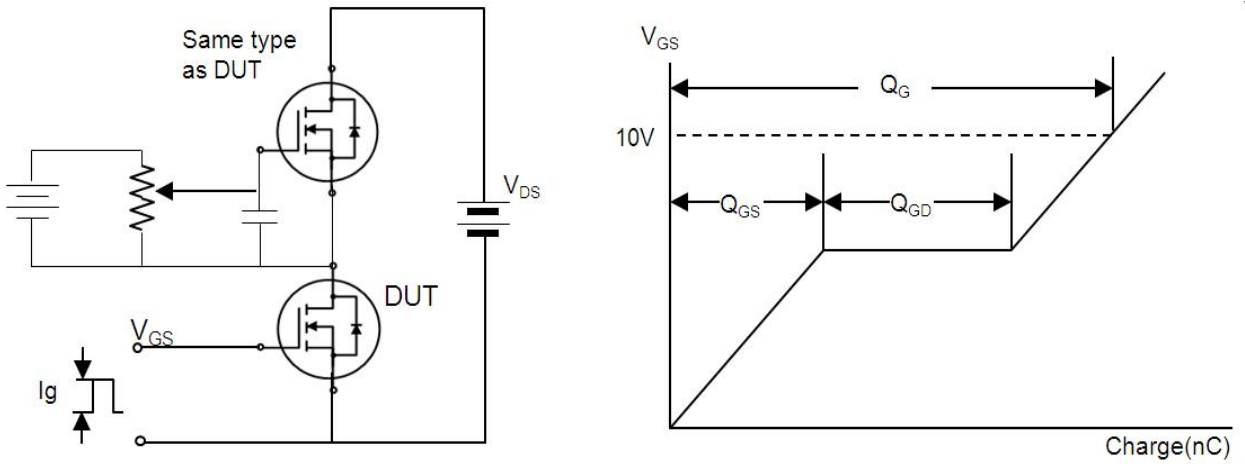

Fig. 22. Transient thermal response curve(TO-251Q&TO-251MQ)



**Fig. 23. Gate charge test circuit & waveform**



**Fig. 24. Switching time test circuit & waveform**

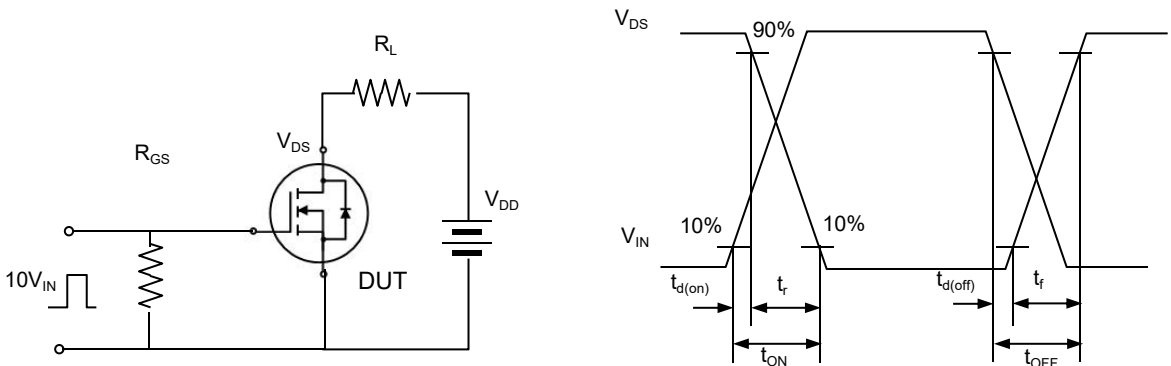

**Fig. 25. Unclamped Inductive switching test circuit & waveform**

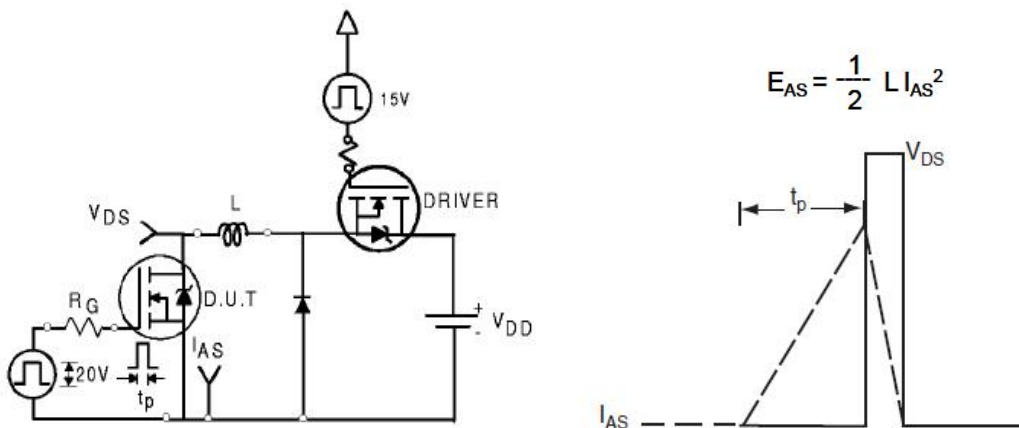
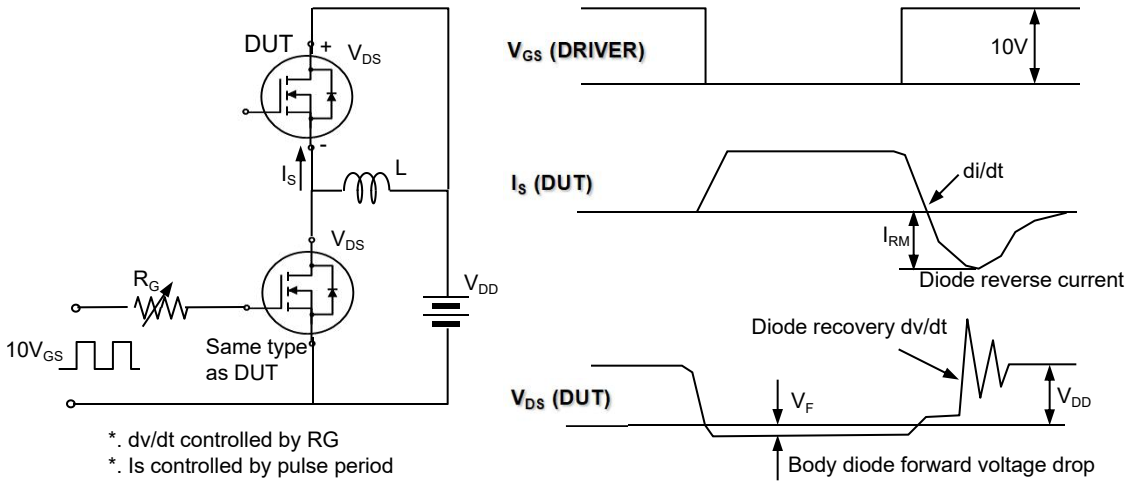





Fig. 26. Peak diode recovery dv/dt test circuit & waveform



## DISCLAIMER

- \* All the data & curve in this document was tested in XI'AN SEMIPOWER TESTING & APPLICATION CENTER.
- \* This product has passed the PCT,TC,HTRB,HTGB,HAST,PC and Solderdunk reliability testing.
- \* Qualification standards can also be found on the Web site (<http://www.semipower.com.cn>) 
- \* Suggestions for improvement are appreciated, Please send your suggestions to [samwin@samwinsemi.com](mailto:samwin@samwinsemi.com)