

N-channel Enhanced mode TO-220/TO-252 MOSFET

Features

- High ruggedness
- Low $R_{DS(ON)}$ (Typ 0.27Ω)@ $V_{GS}=10V$
- Low Gate Charge (Typ 20nC)
- Improved dv/dt Capability
- 100% Avalanche Tested
- Application: Synchronous Rectification, DC-DC

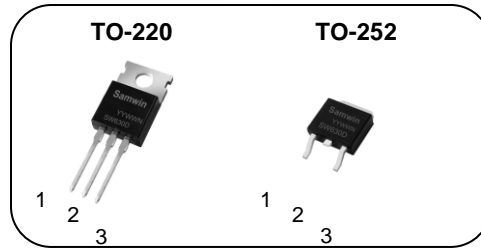

1. Gate 2. Drain 3. Source

BV_{DSS} : 200V
 I_D : 9A
 $R_{DS(ON)}$: 0.27Ω

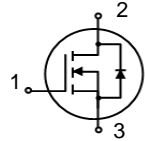

General Description

This power MOSFET is produced with advanced technology of SAMWIN. This technology enable the power MOSFET to have better characteristics, including fast switching time, low on resistance, low gate charge and especially excellent avalanche characteristics.



Order Codes

Item	Sales Type	Marking	Package	Packaging
1	SW P 630D	SW630D	TO-220	TUBE
2	SW D 630D	SW630D	TO-252	REEL

Absolute maximum ratings

Symbol	Parameter	Value		Unit
		TO-220	TO-252	
V_{DSS}	Drain to source voltage	200		V
I_D	Continuous drain current (@ $T_C=25^\circ C$)	9*		A
	Continuous drain current (@ $T_C=100^\circ C$)	5.7*		A
I_{DM}	Drain current pulsed (note 1)	36		A
V_{GS}	Gate to source voltage	±20		V
E_{AS}	Single pulsed avalanche energy (note 2)	156		mJ
E_{AR}	Repetitive avalanche energy (note 1)	16		mJ
dv/dt	Peak diode recovery dv/dt (note 3)	5		V/ns
P_D	Total power dissipation (@ $T_C=25^\circ C$)	138.9	96.2	W
	Derating factor above 25°C	1.1	0.8	W/°C
T_{STG}, T_J	Operating junction temperature & storage temperature	-55 ~ + 150		°C
T_L	Maximum lead temperature for soldering purpose, 1/8 from case for 5 seconds.	300		°C

*. Drain current is limited by junction temperature.

Thermal characteristics

Symbol	Parameter	Value		Unit
		TO-220	TO-252	
R_{thjc}	Thermal resistance, Junction to case	0.9	1.3	°C/W
R_{thja}	Thermal resistance, Junction to ambient	54		°C/W

Electrical characteristic (T_C = 25°C unless otherwise specified)

Symbol	Parameter	Test conditions	Min.	Typ.	Max.	Unit
Off characteristics						
BV _{DSS}	Drain to source breakdown voltage	V _{GS} =0V, I _D =250uA	200			V
ΔBV _{DSS} / ΔT _J	Breakdown voltage temperature coefficient	I _D =250uA, referenced to 25°C		0.23		V/°C
I _{DSS}	Drain to source leakage current	V _{DS} =200V, V _{GS} =0V			1	uA
		V _{DS} =160V, T _C =125°C			50	uA
I _{GSS}	Gate to source leakage current, forward	V _{GS} =20V, V _{DS} =0V			100	nA
	Gate to source leakage current, reverse	V _{GS} =-20V, V _{DS} =0V			-100	nA
On characteristics						
V _{GS(TH)}	Gate threshold voltage	V _{DS} =V _{GS} , I _D =250uA	2		4	V
R _{DS(ON)}	Drain to source on state resistance	V _{GS} =10V, I _D =4.5A		0.27	0.4	Ω
G _{fs}	Forward transconductance	V _{DS} =20V, I _D =4.5A		6.2		S
Dynamic characteristics						
C _{iss}	Input capacitance	V _{GS} =0V, V _{DS} =25V, f=1MHz		720		pF
C _{oss}	Output capacitance			117		
C _{rss}	Reverse transfer capacitance			30		
t _{d(on)}	Turn on delay time	V _{DS} =100V, I _D =9A, R _G =25Ω, V _{GS} =10V (note 4,5)		7		ns
t _r	Rising time			33		
t _{d(off)}	Turn off delay time			41		
t _f	Fall time			29		
Q _g	Total gate charge	V _{DS} =160V, V _{GS} =10V, I _D =9A I _g =13mA (note 4,5)		20		nC
Q _{gs}	Gate-source charge			4		
Q _{gd}	Gate-drain charge			8		
R _g	Gate resistance	V _{DS} =0V, Scan F mode		1.9		Ω

Source to drain diode ratings characteristics

Symbol	Parameter	Test conditions	Min.	Typ.	Max.	Unit
I _S	Continuous source current	Integral reverse p-n Junction diode in the MOSFET			9	A
I _{SM}	Pulsed source current				36	A
V _{SD}	Diode forward voltage drop.	I _S =9A, V _{GS} =0V			1.4	V
t _{rr}	Reverse recovery time	I _S =9A, V _{GS} =0V, di/dt=100A/us		128		ns
Q _{rr}	Reverse recovery charge				556	

※. Notes

1. Repeattive rating : pulse width limited by junction temperature.
2. L =3.85mH, I_{AS} =9A, V_{DD}=50V, R_G=25Ω, Starting T_J = 25°C
3. I_{SD} ≤ 9A, di/dt = 100A/us, V_{DD} ≤ BV_{DSS}, Starting T_J =25°C
4. Pulse Test : Pulse Width ≤ 300us, duty cycle ≤ 2%.
5. Essentially independent of operating temperature.

Fig. 1. On-state characteristics

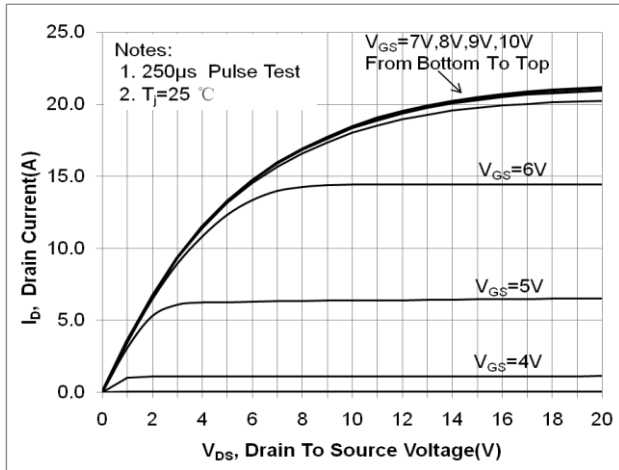

Fig. 2. Transfer characteristics

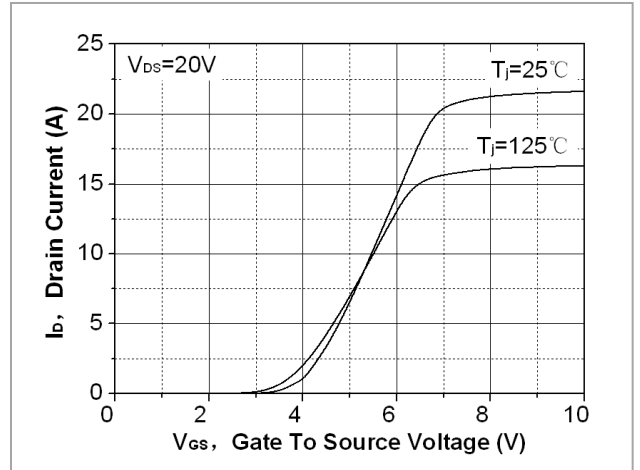

Fig. 3. On-resistance variation vs. drain current and gate voltage

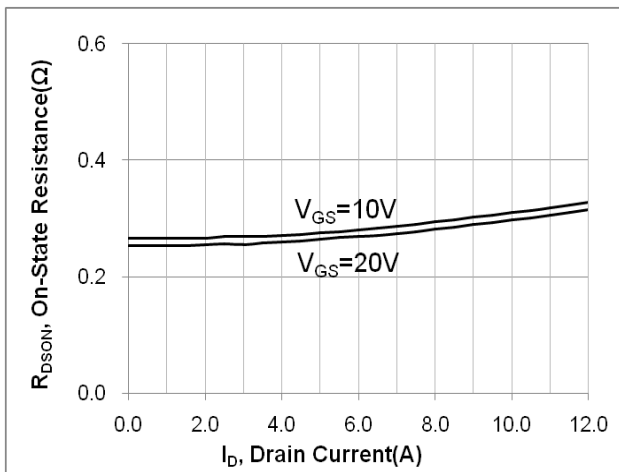

Fig. 4. On-state current vs. diode forward voltage

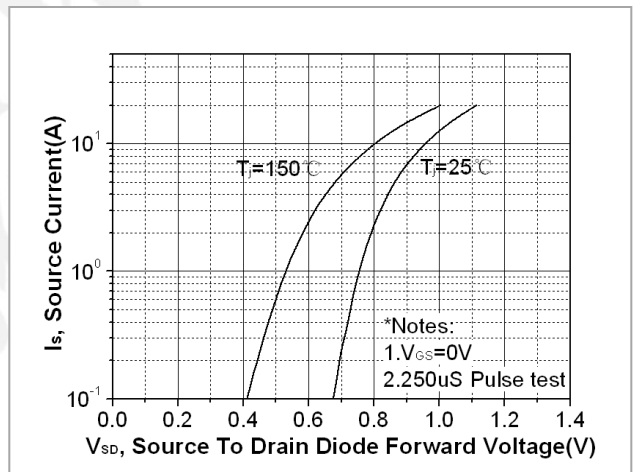

Fig 5. Breakdown voltage variation vs. junction temperature

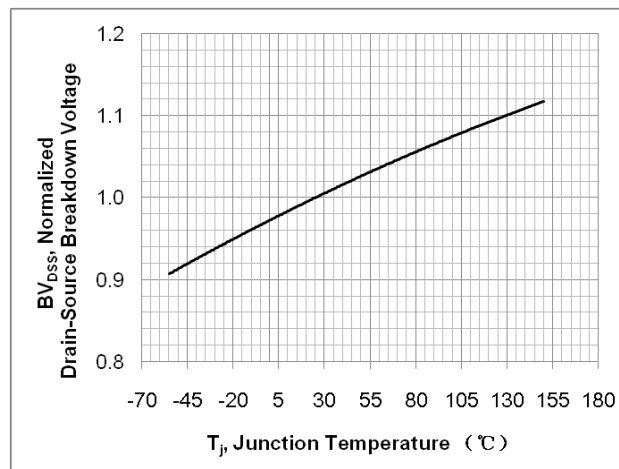

Fig. 6. On-resistance variation vs. junction temperature

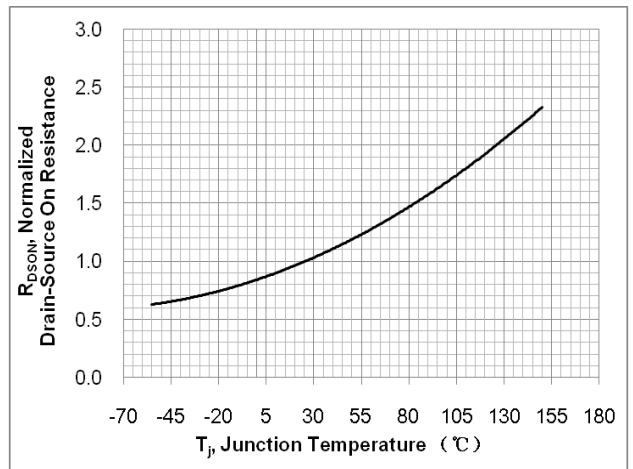

Fig. 7. Gate charge characteristics

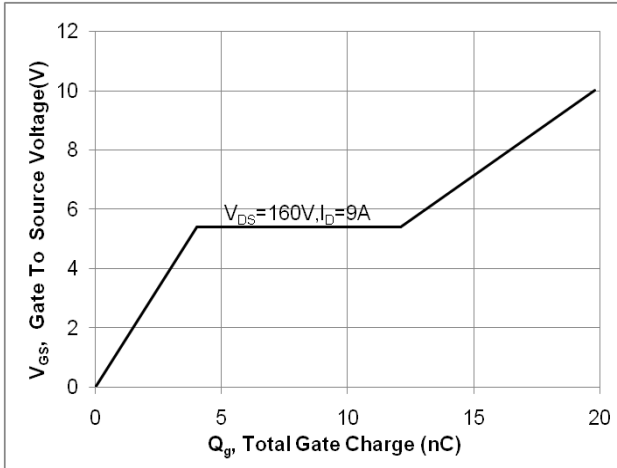

Fig. 8. Capacitance Characteristics

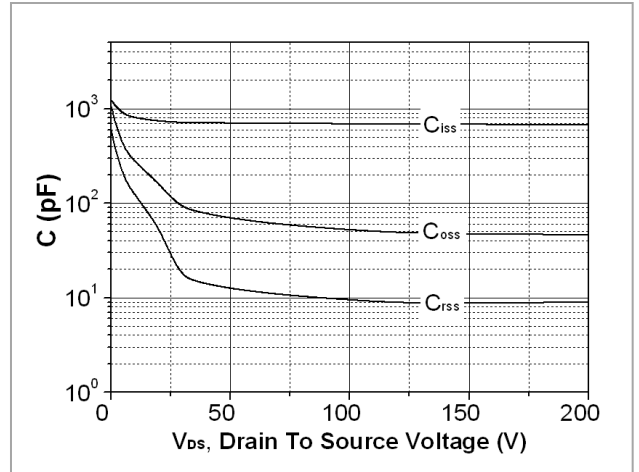

Fig. 9. Maximum safe operating area(TO-220)

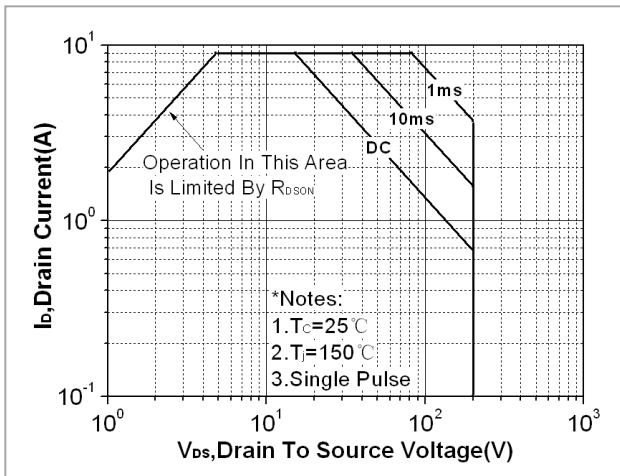

Fig. 10. Maximum safe operating area(TO-252)

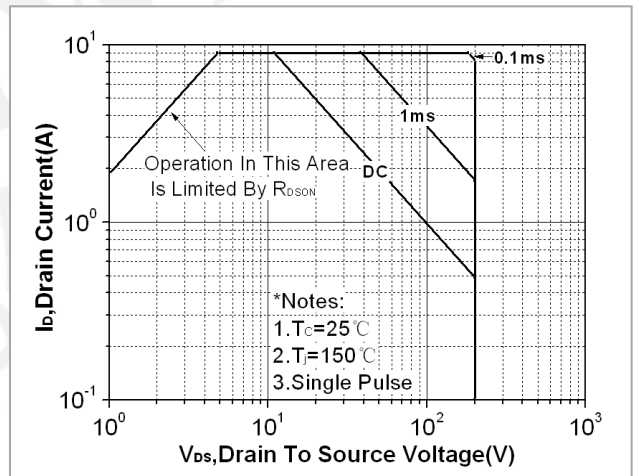

Fig. 11. Transient thermal response curve(TO-220)

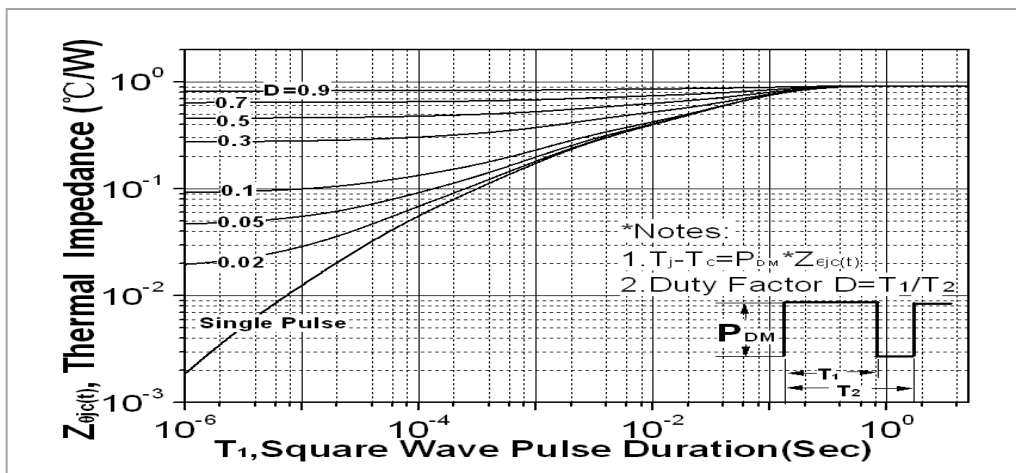

Fig. 12. Transient thermal response curve(TO-252)

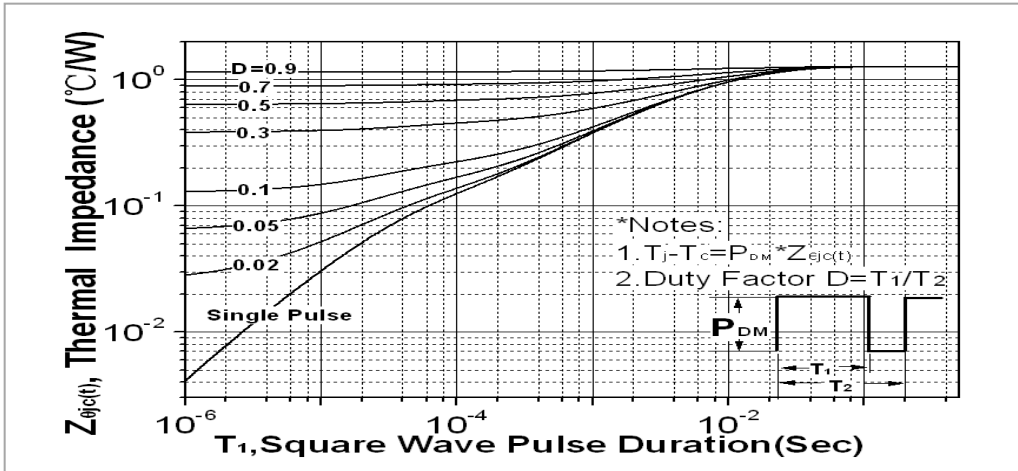

Fig. 13. Gate charge test circuit & waveform

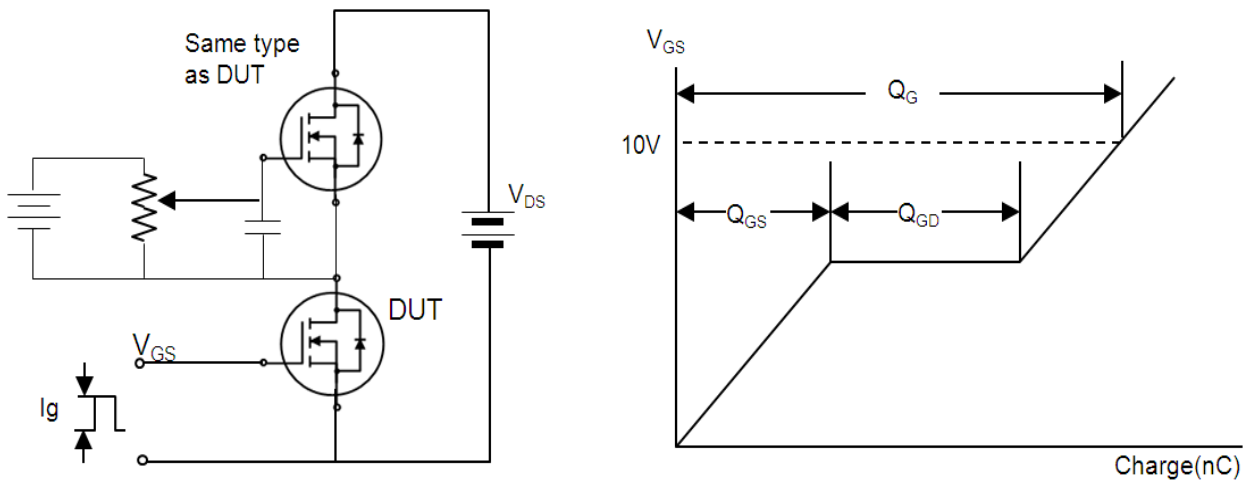

Fig. 14. Switching time test circuit & waveform

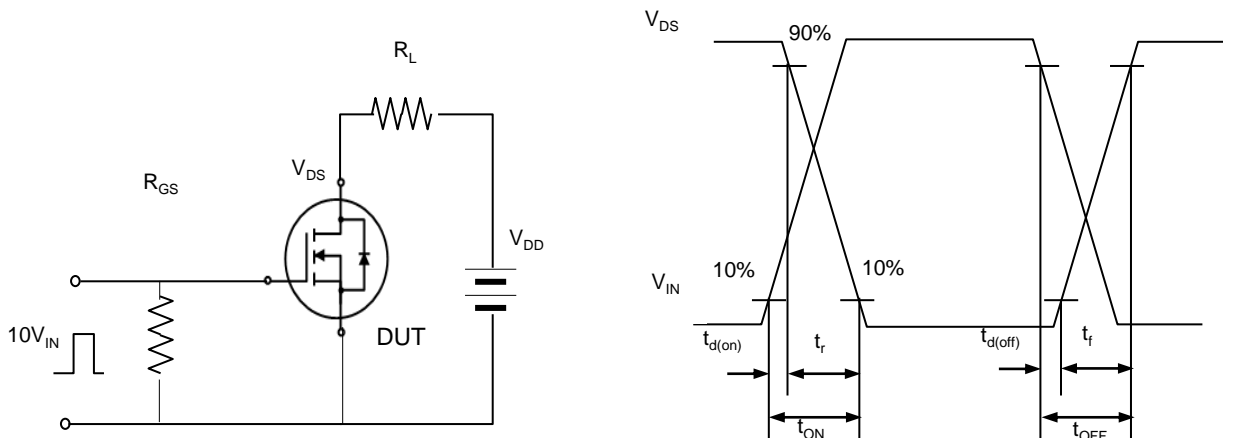

Fig. 15. Unclamped Inductive switching test circuit & waveform

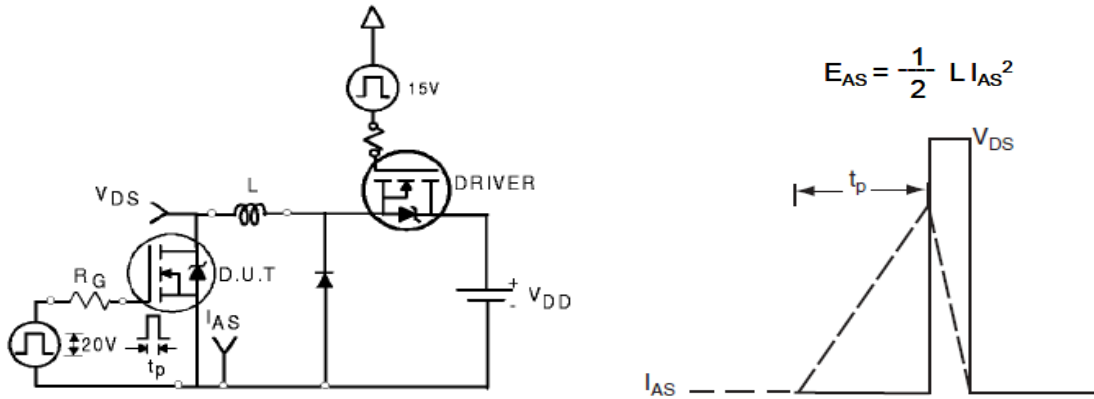
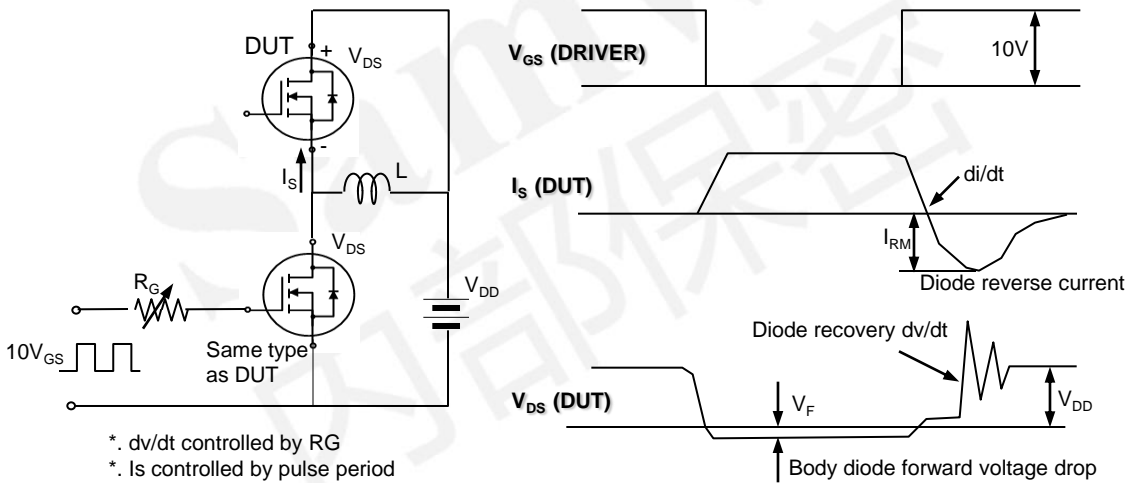

Fig. 16. Peak diode recovery dv/dt test circuit & waveform



DISCLAIMER

- * All the data & curve in this document was tested in XI'AN SEMIPOWER TESTING & APPLICATION CENTER.
- * This product has passed the PCT,TC,HTRB,HTGB,HAST,PC and Solderdunk reliability testing.
- * Qualification standards can also be found on the Web site (<http://www.semipower.com.cn>)
- * Suggestions for improvement are appreciated, Please send your suggestions to samwin@samwinsemi.com