

Thyristor Surge Suppressors (TSS)

P0080SA - P4200SA Series - DO-214AA(SMB)

@10/700 μ S, 2KV

Description

P0080SA - P4200SA Series are designed to protect broadband equipment such as modems, line card, CPE and DSL from damaging over-voltage transients.

The series provides a surface mount solution that enables equipment to comply with global regulatory standards.

Features and Benefits

- ◆ Low voltage overshoot
- ◆ Low on-state voltage
- ◆ Does not degrade surge capability after multiple surge events within limit
- ◆ Fails short circuit when surged in excess of ratings
- ◆ Low Capacitance

Applicable Global Standards

- ◆ TIA-968-A
- ◆ ITU K.20/21 Enhanced level
- ◆ ITU K.20/21 Basic Level
- ◆ GR 1089 Inter building
- ◆ GR 1089 Inter building
- ◆ IEC 6100-4-5
- ◆ YD/T 1082
- ◆ YD/T 993
- ◆ YD/T 950



Schematic Symbol

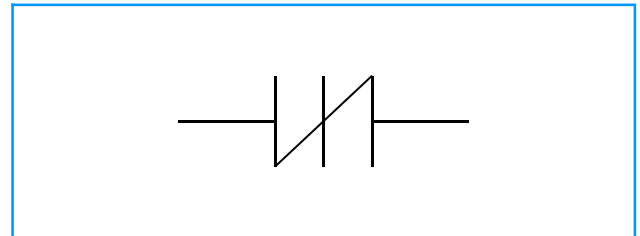

Electrical Parameters

Parameter	Definition
I_S	Switching Current - maximum current required to switch to on state
I_{DRM}	Leakage Current - maximum peak off-state current measured at V_{DRM}
I_H	Holding Current - minimum current required to maintain on state
I_T	On-state Current - maximum rated continuous on-state current
V_S	Switching Voltage - maximum voltage prior to switching to on stat
V_{DRM}	Peak Off-state Voltage - maximum voltage that can be applied while maintaining off state
V_T	On-state Voltage - maximum voltage measured at rated on-state current
C_0	Off-state Capacitance - typical capacitance measured in off state

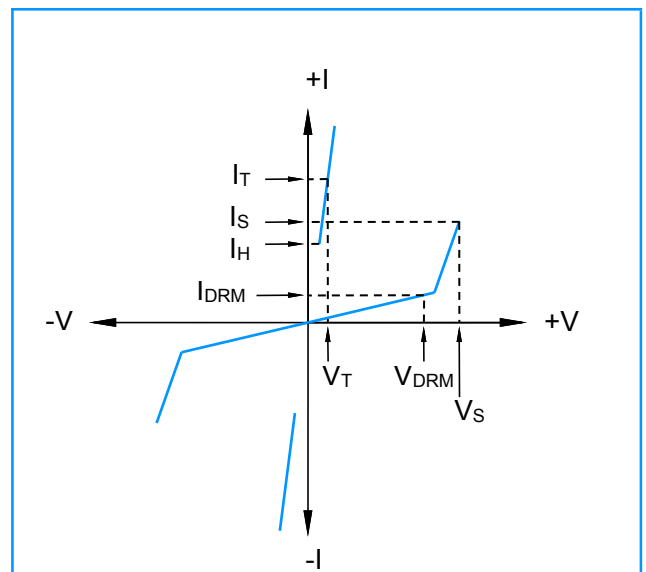

Thyristor Surge Suppressors (TSS)

P0080SA - P4200SA Series - DO-214AA(SMB) @10/700 μ S, 2KV

Electrical Characteristics

Part Number	Marking	V_{DRM} @ $I_{DRM}=5\mu A$	V_S @100V/ μS	V_T @ $I_T=2.2A$	I_S	I_T	I_H	C_0 @1MHz	
		V min	V max	V max	mA max	A max	mA min	pF min	pF max
P0080SA	P008A	6	25	4	800	2.2	50	25	150
P0300SA	P03A	25	40	4	800	2.2	50	15	140
P0640SA	P06A	58	77	4	800	2.2	150	40	60
P0720SA	P07A	65	88	4	800	2.2	150	35	60
P0900SA	P09A	75	98	4	800	2.2	150	25	55
P1100SA	P11A	90	130	4	800	2.2	150	30	50
P1300SA	P13A	120	160	4	800	2.2	150	25	45
P1500SA	P15A	140	180	4	800	2.2	150	25	40
P1800SA	P18A	170	220	4	800	2.2	150	25	35
P2000SA	P20A	180	220	4	800	2.2	150	20	35
P2300SA	P23A	190	260	4	800	2.2	150	25	35
P2600SA	P26A	220	300	4	800	2.2	150	20	35
P3100SA	P31A	275	350	4	800	2.2	150	20	35
P3500SA	P35A	320	400	4	800	2.2	150	20	35
P4000SA	P40A	360	460	4	800	2.2	150	20	35
P4200SA	P42A	400	520	4	800	2.2	150	20	35

Notes:

- Absolute maximum ratings measured at $T_A=25^\circ C$ (unless otherwise noted).
- Devices are bi-directional.

Surge Ratings

Series	2/10 μS^1	8/20 μS^1	10/160 μS^1	10/560 μS^1	10/1000 μS^1	5/310 μS^1	I_{TSM} 50/60 Hz	di/dt
	2/10 μS^2	1.2/50 μS^2	10/160 μS^2	10/560 μS^2	10/1000 μS^2	10/700 μS^2		
	A min	A min	A min	A min	A min	A min		
A	150	150	90	50	45	50	20	500

Notes:

- Current waveform in μs
 - Voltage waveform in μs
- Peak pulse current rating (I_{PP}) is repetitive and guaranteed for the life of the product.
 - I_{PP} ratings applicable over temperature range of $-40^\circ C$ to $+85^\circ C$
 - The device must initially be in thermal equilibrium with $-40^\circ C < T_J < +150^\circ C$

Thermal Considerations

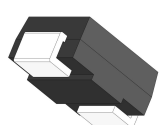
Package	Symbol	Parameter	Value	Unit
DO-214AA 	T_J	Operating Junction Temperature Range	- 40 to + 150	$^\circ C$
	T_S	Storage Temperature Range	- 40 to +150	$^\circ C$
	$R_{\theta JA}$	Thermal Resistance: Junction to Ambient	90	$^\circ C/W$

Thyristor Surge Suppressors (TSS)

P0080SA - P4200SA Series - DO-214AA(SMB) @10/700 μ S, 2KV

Characteristic Curves

Figure 1 - V-I Characteristics

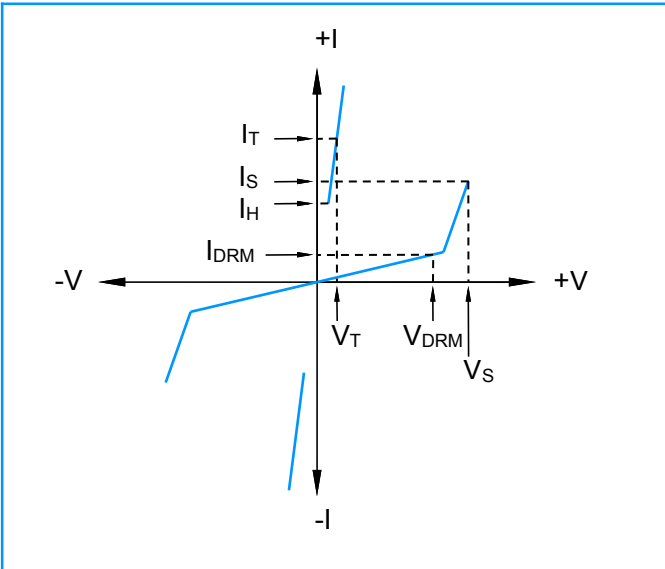

Figure 2 - $t_r \times t_d$ Pulse Waveform

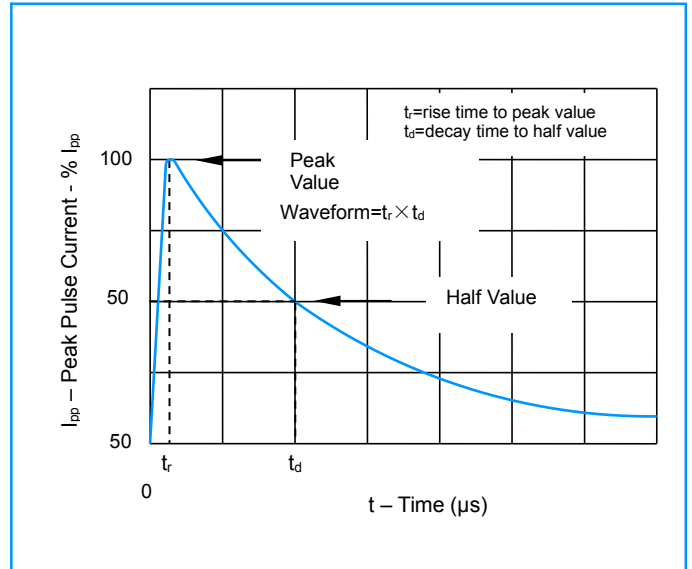

Figure 3 - Normalized V_S Change Versus Junction Temperature

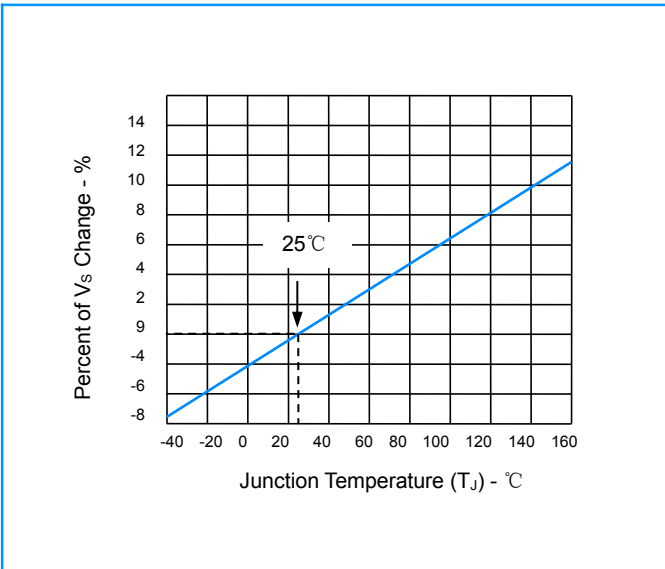
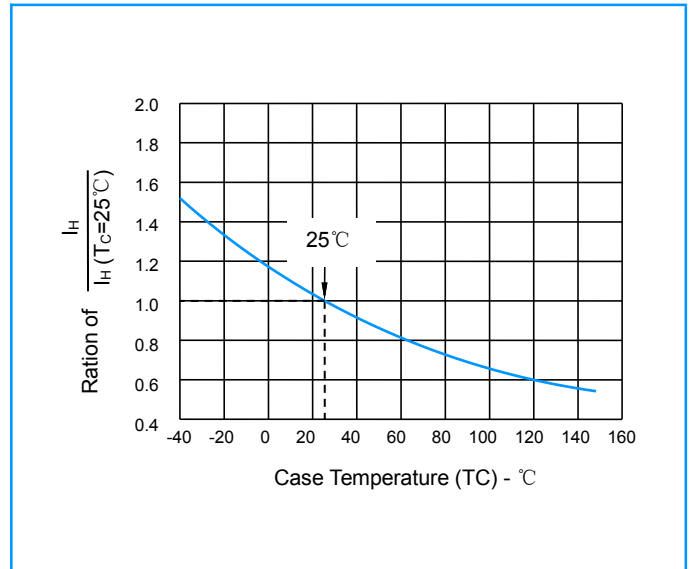

Figure 4 - Normalized DC Holding Current Versus Case Temperature



Thyristor Surge Suppressors (TSS)

P0080SA - P4200SA Series - DO-214AA(SMB)
@10/700 μ S, 2KV

Environmental Specifications

High Temp Voltage Blocking	80% Rated VDRM (VAC Peak) +125°C or +150°C, Lead Material Copper Alloy High Temp Voltage Blocking 504 or 1008 hrs. MIL-STD-750 (Method 1040) JEDEC, JESD22-A-101
Temp Cycling	-65°C to +150°C, 15 min. dwell, 10 up to 100 cycles. MIL-STD-750 (Method 1051) EIA/JEDEC, JESD22-A104
Biased Temp & Humidity	52 VDC (+85°C) 85%RH, 504 up to 1008 hrs. EIA/JEDEC, JESD22-A-101
High Temp Storage	+150°C 1008 hrs. MIL-STD-750 (Method 1031) JEDEC, JESD22-A-101
Low Temp Storage	-65°C, 1008 hrs.
Thermal Shock	0°C to +100°C, 5 min. dwell, 10 sec. transfer, Thermal Shock 10 cycles. MIL-STD-750 (Method 1056) JEDEC, JESD22-A-106
Autoclave (Pressure Cooker Test)	+121°C, 100%RH, 2atm, 24 up to 168 hrs. EIA/Cooker Test) JEDEC, JESD22-A-102
Resistance to Solder Heat	+260°C, 30 secs. MIL-STD-750 (Method 2031)
Moisture Sensitivity Level	85%RH, +85°C, 168 hrs., 3 reflow cycles Level (+260°C Peak). JEDEC-J-STD-020, Level 1

Physical Specifications

Lead Material	Copper Alloy
Terminal Finish	100% Matte-Tin Plated
Body Material	UL recognized epoxy meeting flammability classification 94V-0

Soldering Parameters

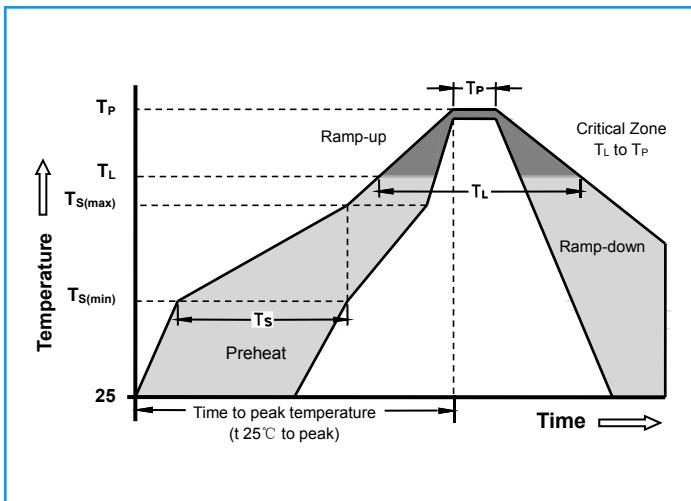

Reflow Condition		Lead-free assembly
Pre Heat	-Temperature Min ($T_{s(min)}$)	+150°C
	-Temperature Max ($T_{s(max)}$)	+200°C
	-Time (min to max) (T_s)	60 -180 Seconds
Average ramp up rate (Liquidus Temp T_L to peak)		3°C/Second Max
$T_{s(max)}$ to T_L - Ramp-up Rate		3°C/Second Max
Reflow	- Temperature (T_L) (Liquidus)	+217°C
	- Time (min to max) (T_L)	60 -150 Seconds
Peak Temperature (T_P)		260 +0/-5°C
Time within 5°C of actual peak Temperature (t_p)		30 Seconds Max
Ramp-down Rate		6°C/Second Max
Time 25°C to peak Temperature (T_P)		8 minutes Max
Do not exceed		+260°C

Thyristor Surge Suppressors (TSS)

P0080SA - P4200SA Series - DO-214AA(SMB)

@10/700µS, 2KV

Part Numbering

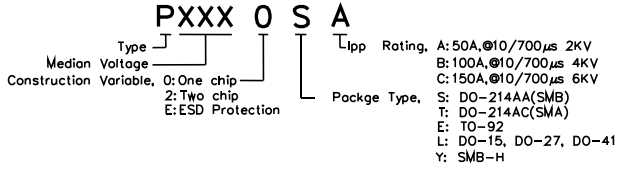

Part Marking

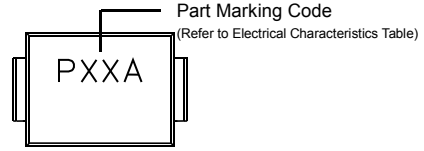

Dimensions DO-214AA

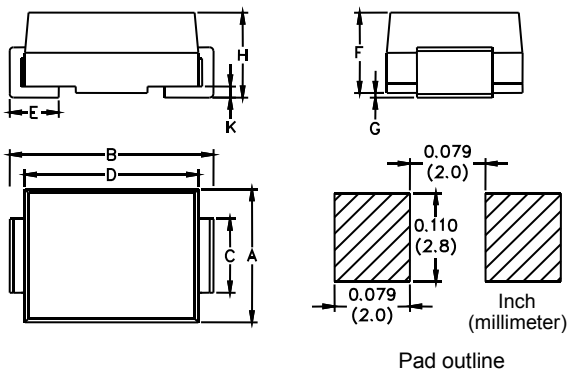

Dimensions	Inches		Millimeters	
	Min	Max	Min	Max
A	0.130	0.156	3.30	3.95
B	0.201	0.220	5.10	5.60
C	0.077	0.087	1.95	2.20
D	0.159	0.181	4.05	4.60
E	0.030	0.063	0.76	1.60
F	0.076	0.096	1.90	2.45
G	0.002	0.008	0.05	0.20
H	0.077	0.104	1.95	2.65
K	0.006	0.016	0.15	0.41

Packaging

Part Number	Component Package	Quantity	Packaging Option	Packaging Specification
Pxxx0SA	DO-214AA	2500	Tape & Reel -12mm/13"tape	EIA -481 - D

Tape and Reel Specifications

