

SESD3Z SERIES
Transient Voltage Suppressors for ESD Protection

Revision:A

General Description

The SESD3Z series is designed to protect voltage sensitive components from ESD and transient voltage events. Excellent clamping capability, low leakage, and fast response time, make these parts ideal for ESD protection on designs where board space is at a premium.

Applications

- Cellular Phone Handsets and Accessories
- Microprocessor based equipment
- Personal Digital Assistants(PDA'S)
- Notebooks, Desktops, and Servers
- Portable Instrumentation
- Pagers Peripherals

Features

- Small Body Outline Dimensions
- 350 Watts peak pulse power (tp = 8/20μs)
- Transient protection for data lines to
- Small package for use in portable electronics
- Suitable replacement for MLV's in ESD protection applications
- Protects one I/O or power line
- Low clamping voltage
- Low leakage current
- Solid-state silicon-avalanche technology

Complies with the following standards
IEC61000-4-2

Level 4 15 kV (air discharge)

8 kV(contact discharge)

MIL STD 883E - Method 3015-7 Class 3
25 kV HBM (Human Body Model)

Functional diagram



SOD-323

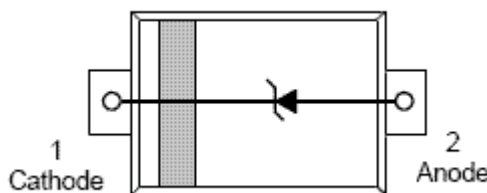

Absolute Ratings (Tamb=25°C)

Symbol	Parameter	Value	Units
P _{PK}	Peak Pulse Power (tp = 8/20μs)	350	W
V _{ESD}	ESD Voltage(HBM Waveform per IEC 61000-4-2)	8	kV
T _L	Maximum lead temperature for soldering during 10s	260	°C
T _{STG}	Storage Temperature Range	-55 to +150	°C
T _J	Maximum junction temperature	-55 to +125	°C
I _{PP}	Maximum Reverse Peak Pulse Current	24	A

Electrical Parameter

Symbol	Parameter
I_{PP}	Maximum Reverse Peak Pulse Current
V_C	Clamping Voltage @ I_{PP}
V_{RWM}	Working Peak Reverse Voltage
I_R	Maximum Reverse Leakage Current @ V_{RWM}
I_T	Test Current
V_{BR}	Breakdown Voltage @ I_T
I_F	Forward Current
V_F	Forward Voltage @ I_F

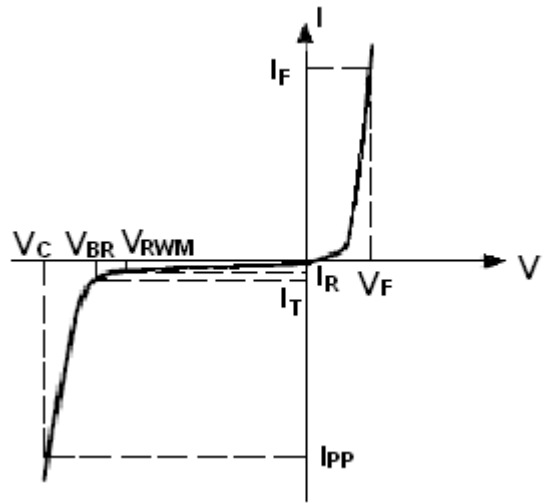

Electrical Characteristics Ratings at 25°C ambient temperature unless otherwise specified.

Part Numbers	V_{BR}			I_T	V_{RWM}	I_R	V_F	I_F	C
	Min	Typ	Max				Max.		Typ. (Note1)
	V	V	V	mA	V	μA	V	mA	pF
SESD3Z5V	6.1	6.7	7.2	1.0	5.0	1	1.25	200	370
SESD3Z12V	13.3	14.0	14.7	1.0	12.0	1	1.25	200	250
SESD3Z16V	17.2	18.0	18.8	1.0	16.0	1	1.25	200	200

1. Capacitance is measured at $f=1\text{MHz}$, $V_R=0\text{V}$, $T_A=25^\circ\text{C}$.

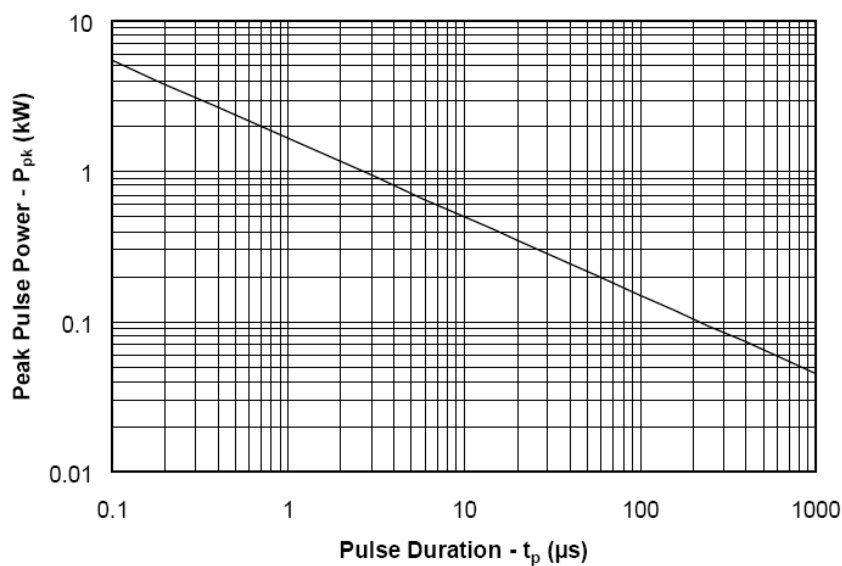

Fig.1 Non-Repetitive Peak Pulse Power vs. Pulse Time

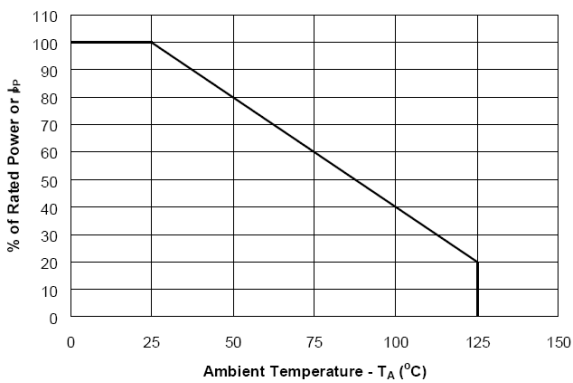

Fig.2 Power Derating Curve

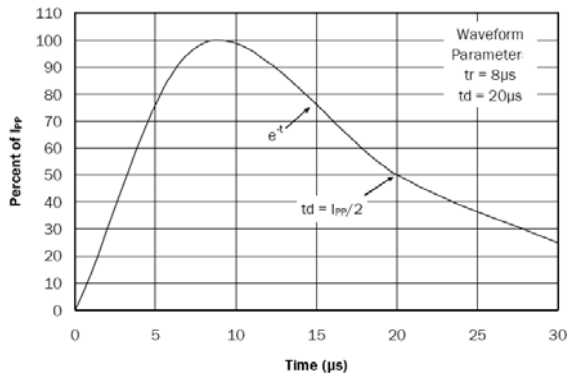

Fig.3 Waveform

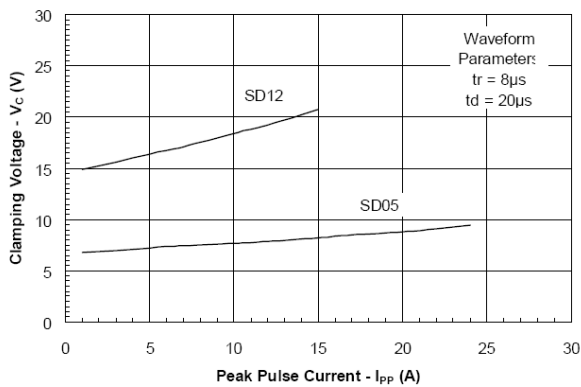

Fig.4 Clamping Voltage vs. Peak Pulse Current

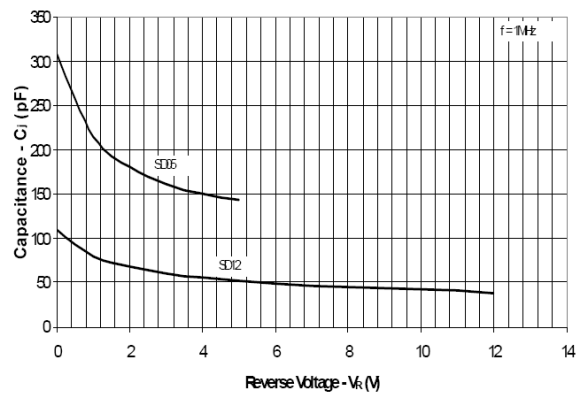

Fig.5 Capacitance vs. Reverse Voltage

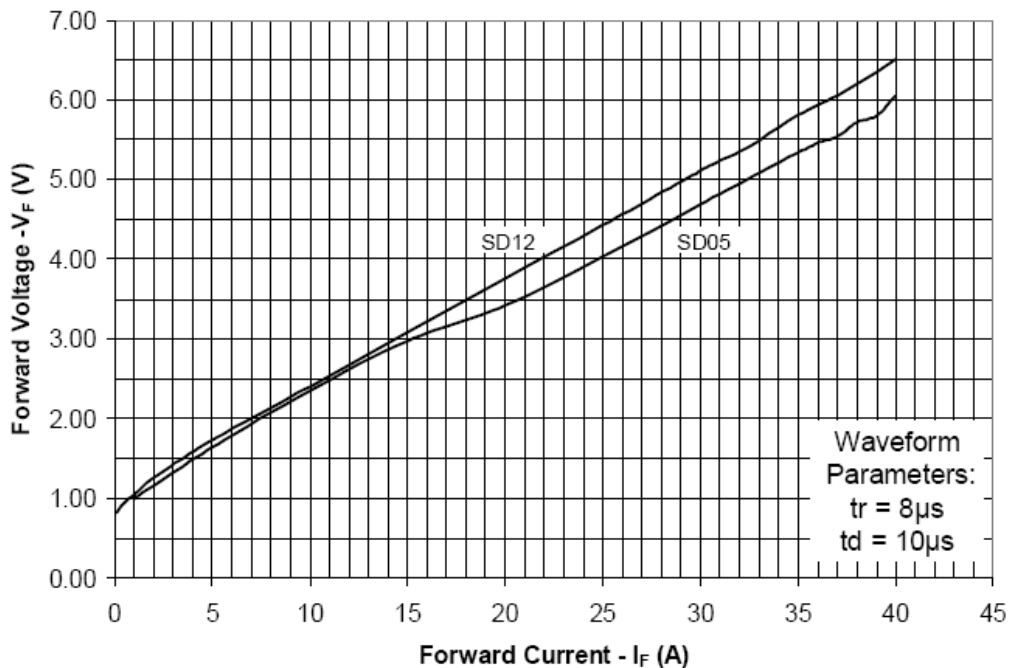
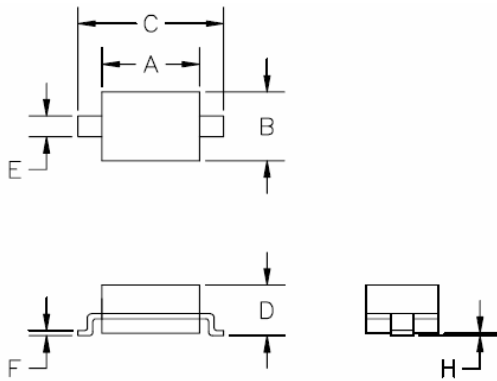

Fig.6 Forward Voltage vs. Forward Current

SESD3Z SERIES

SOD-323 Mechanical Data



Dim	Dimensions			
	Inches		Millimeters	
	Min	Max	Min	Max
A	0.060	0.071	1.5	1.8
B	0.045	0.054	1.2	1.4
C	0.060	0.107	2.3	2.7
D	-	0.043	-	1.1
E	0.012	0.016	0.3	0.4
F	0.004	0.010	0.10	0.25
H	-	0.004	-	0.10

CONTROLLING DIMENSION: MILLIMETERS

Land Pattern

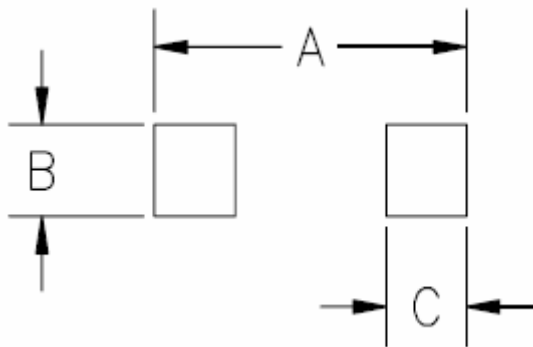

Dim	Dimensions			
	Inches		MM	
	Min	Max	Min	Max
A	-	0.120	-	3.05
B	-	0.031	-	0.8
C	-	0.031	-	0.8

The SINO-IC logo is a registered trademark of Shanghai Sino-IC Microelectronics Co., Ltd.

© 2005 SINO-IC – Printed in China – All rights reserved.

SHANGHAI SINO-IC MICROELECTRONICS CO., LTD

Add: Building 3, Room 3401-03, No.200 Zhangheng Road, ZhangJiang Hi-Tech Park, Pudong, Shanghai 201203, China

Phone: +86-21-33932402 33932403 33932405 33933508 33933608

Fax: +86-21-33932401

Email: szrxw002@126.com

Website: <http://www.sino-ic.net>