

SE60210GA

N-Channel Enhancement-Mode MOSFET

Revision: A

General Description

This type used advanced trench technology and design to provide excellent $R_{DS(ON)}$ with low gate charge.

- I High density cell design for ultra low $R_{DS(ON)}$
- I Excellent package for good heat dissipation

Features

For a single MOSFET

- I $V_{DS} = 60V$
- I $R_{DS(ON)} = 2.2m\Omega @ V_{GS}=10V$
- I

Pin configurations

See Diagram below



Absolute Maximum Ratings

Parameter		Symbol	Rating	Units
Drain-Source Voltage		V_{DS}	60	V
Gate-Source Voltage		V_{GS}	± 20	V
Drain Current	Continuous	I_D	210	A
	Pulsed		800	
Total Power Dissipation	@TA=25°C	P_D	300	W
Operating Junction Temperature Range		T_J	-55 to 175	°C

SE60210GA

Electrical Characteristics (T _J =25°C unless otherwise noted)						
Symbol	Parameter	Test Conditions	Min	Typ	Max	Units
OFF CHARACTERISTICS (Note 2)						
B _V DSS	Drain-Source Breakdown Voltage	I _D =250μA, V _{GS} =0 V	60			V
I _{DSS}	Drain to Source Leakage Current	V _{DS} = 48V, V _{GS} =0V			1	μA
I _{GSS}	Gate-Body Leakage Current	V _{GS} =20V			100	nA
V _{GS(th)}	Gate Threshold Voltage	V _{DS} = V _{GS} , I _D =250μA	2.0	3.0	4.0	V
R _{DS(ON)}	Static Drain-Source On-Resistance	V _{GS} =10V, I _D =20A		2.2	2.6	mΩ
DYNAMIC PARAMETERS						
C _{iss}	Input Capacitance	V _{GS} =0V, V _{DS} =30V, f=1MHz		7070		pF
C _{oss}	Output Capacitance			2140		pF
C _{rss}	Reverse Transfer Capacitance			63		pF
SWITCHING PARAMETERS						
Q _g	Total Gate Charge ²	V _{GS} =10V, V _{DS} =30V, I _D =20A		85		nC
Q _{gs}	Gate Source Charge			24		nC
Q _{gd}	Gate Drain Charge			14		nC
t _{d(on)}	Turn-On Delay Time	V _{GS} =10V, V _{DS} =30V, R _{GEN} =10Ω		36		ns
t _{d(off)}	Turn-Off Delay Time			95		ns
t _{d(r)}	Turn-On Rise Time			62		ns
t _{d(f)}	Turn-Off Fall Time			34		ns
Thermal Resistance						
Symbol	Parameter			Typ		Units
R _{θJC}	Junction to Case			0.5		°C/W

Typical Characteristics

Fig 1. Typical Output Characteristics

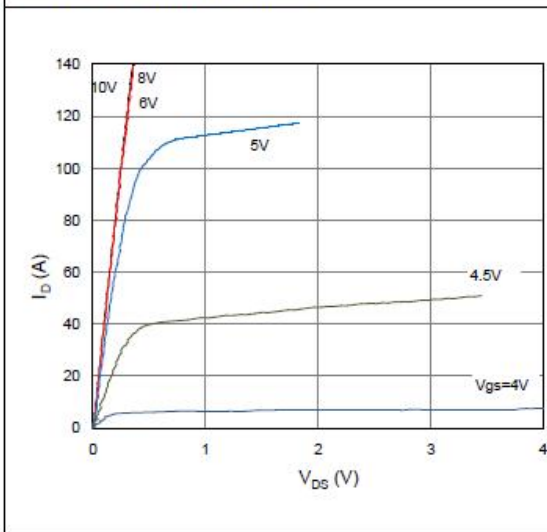

Figure 2. On-Resistance vs. Gate-Source Voltage

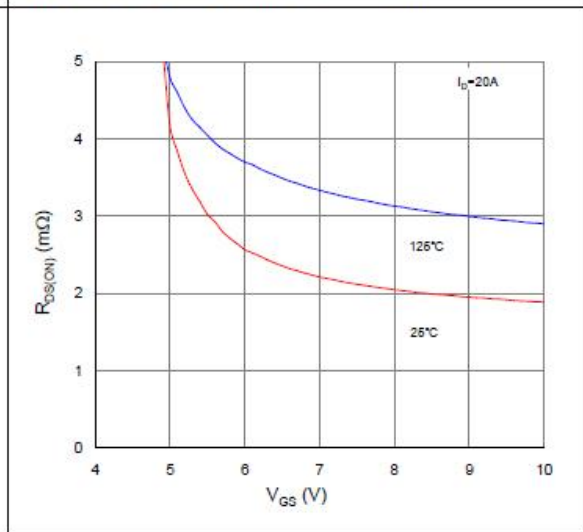

Figure 3. On-Resistance vs. Drain Current and Gate Voltage

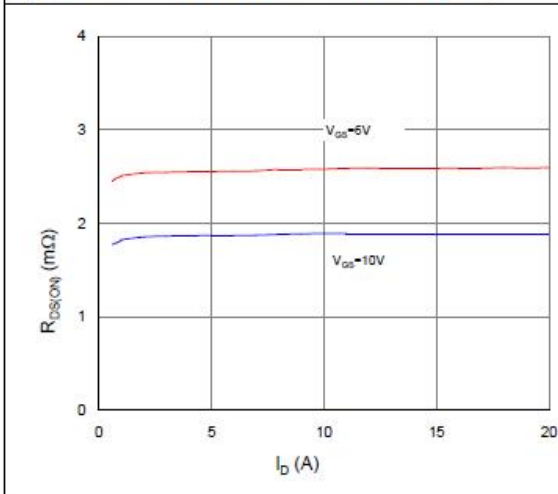

Figure 4. Normalized On-Resistance vs. Junction Temperature

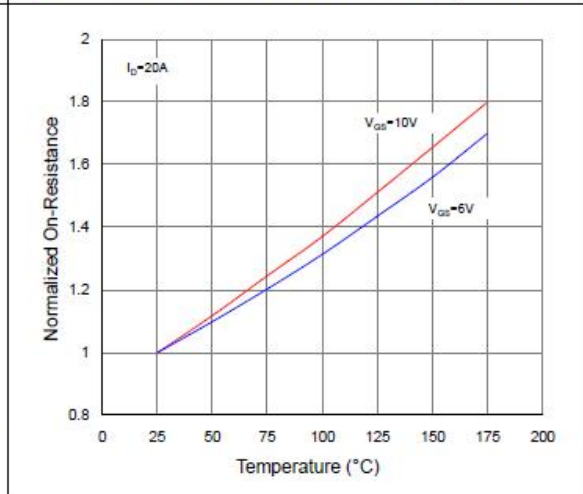

Figure 5. Typical Transfer Characteristics

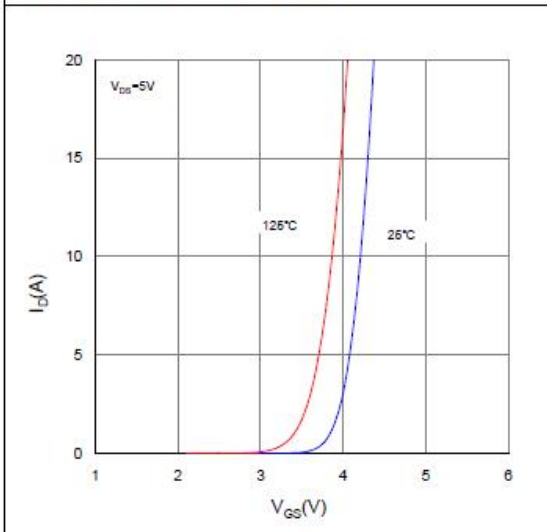
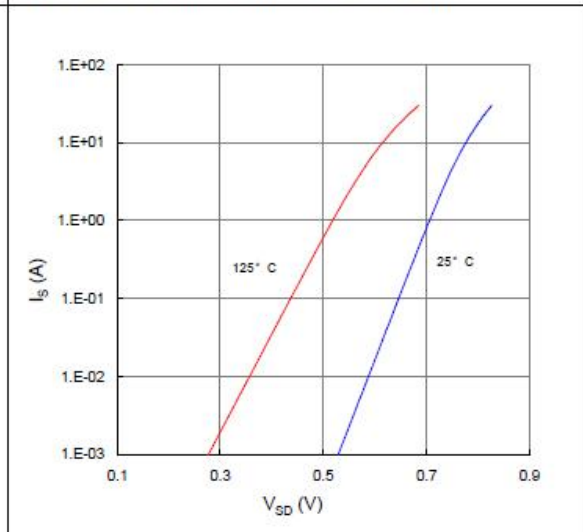

Figure 6. Typical Source-Drain Diode Forward Voltage



Typical Characteristics

Figure 7. Typical Gate-Charge vs. Gate-to-Source Voltage

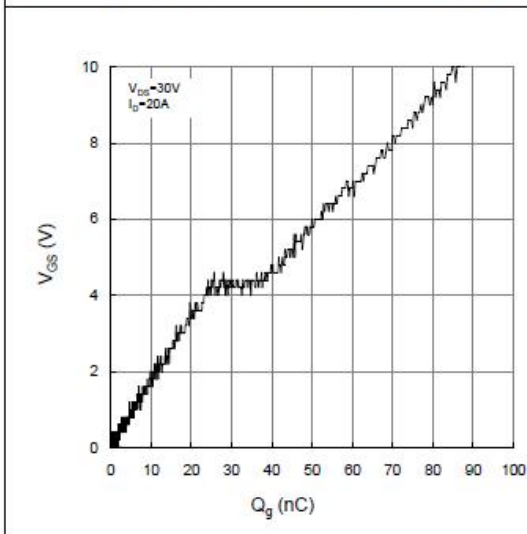

Figure 8. Typical Capacitance vs. Drain-to-Source Voltage

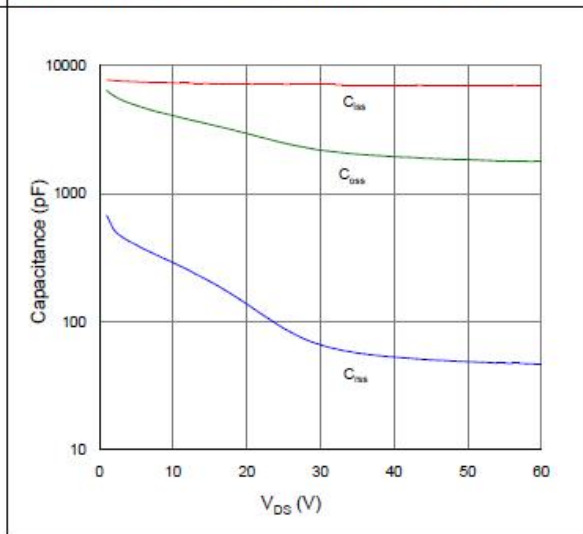

Figure 9. Maximum Safe Operating Area

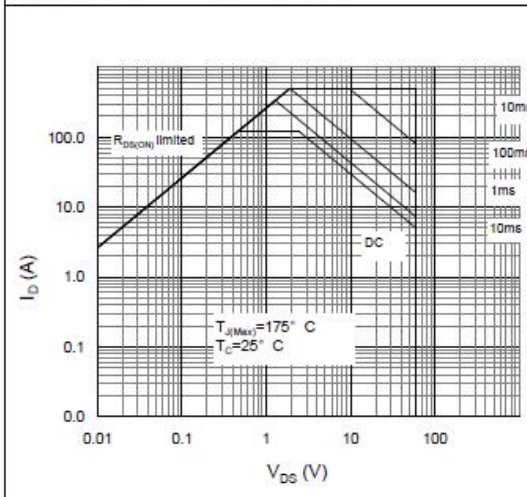

Figure 10. Maximum Drain Current vs. Case Temperature

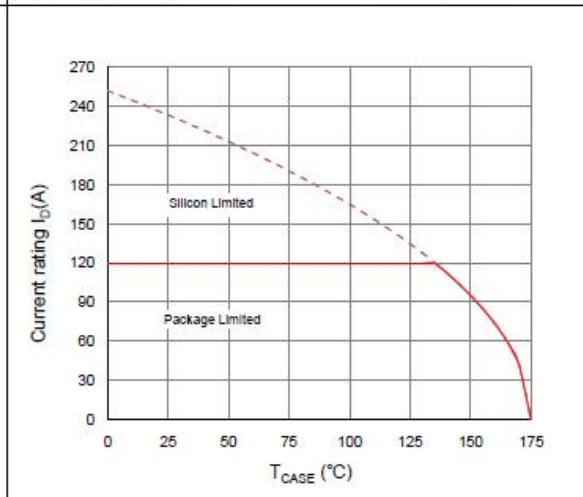
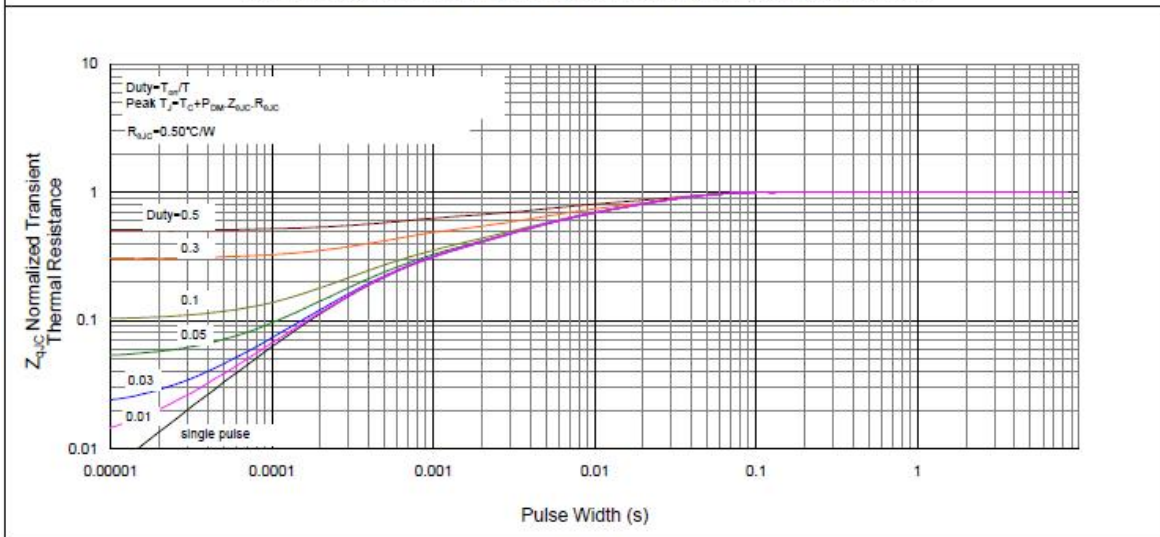

Figure 11. Normalized Maximum Transient Thermal Impedance, Junction-to-Case



SE60210GA

Package Outline Dimension

TO-220

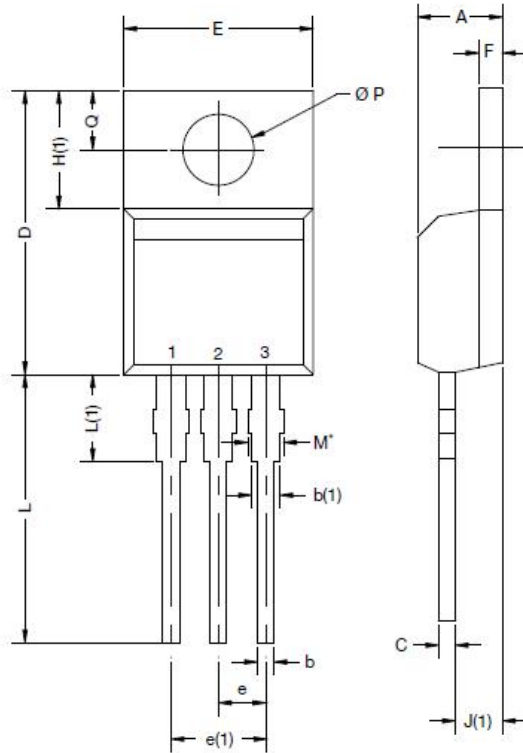

DIM.	MILLIMETERS		INCHES	
	MIN.	MAX.	MIN.	MAX.
A	4.24	4.65	0.167	0.183
b	0.69	1.02	0.027	0.040
b(1)	1.14	1.78	0.045	0.070
c	0.36	0.61	0.014	0.024
D	14.33	15.85	0.564	0.624
E	9.96	10.52	0.392	0.414
e	2.41	2.67	0.095	0.105
e(1)	4.88	5.28	0.192	0.208
F	1.14	1.40	0.045	0.055
H(1)	6.10	6.71	0.240	0.264
J(1)	2.41	2.92	0.095	0.115
L	13.36	14.40	0.526	0.567
L(1)	3.33	4.04	0.131	0.159
Ø P	3.53	3.94	0.139	0.155
Q	2.54	3.00	0.100	0.118