

SE47NS65TS

**N-Channel Enhancement-Mode COOLMOSFET**

Revision: A

**General Description**

Thigh Density Cell Design For Ultra Low On-Resistance Fully Characterized Avalanche Voltage and Current Improved Shoot-Through FOM

- Simple Drive Requirement
- Small Package Outline
- Surface Mount Device

**Features**

For a single MOSFET

- $V_{DS} = 650V$
- $R_{DS(ON)} = 60m\Omega @ V_{GS}=10V$

**Pin configurations**

See Diagram below

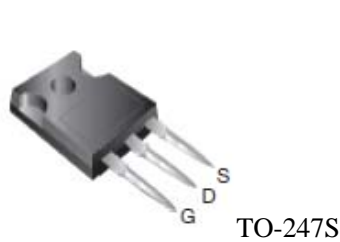

**Absolute Maximum Ratings**

Parameter		Symbol	Rating	Units
Drain-Source Voltage		$V_{DS}$	650	V
Gate-Source Voltage		$V_{GS}$	$\pm 30$	V
Drain Current	Continuous	$I_D$	47	A
	Pulsed		140	
Total Power Dissipation	@TC=25°C	$P_D$	391	W
Operating Junction Temperature Range		$T_J$	-55 to 150	°C

**Thermal Resistance**

Symbol	Parameter	Min	Max	Units
$R_{\theta JC}$	Junction to Case		0.32	°C/W
$R_{\theta JA}$	Junction to Ambient ( $t \leq 10s$ )		62	°C/W

# SE47NS65TS

Electrical Characteristics (T <sub>J</sub> =25°C unless otherwise noted)						
Symbol	Parameter	Test Conditions	Min	Typ	Max	Units
<b>OFF CHARACTERISTICS (Note 2)</b>						
B <sub>V</sub> DSS	Drain-Source Breakdown Voltage	I <sub>D</sub> =250μA, V <sub>GS</sub> =0 V	650			V
I <sub>DSS</sub>	Drain to Source Leakage Current	V <sub>DS</sub> = 600V, V <sub>GS</sub> =0V			1	μA
I <sub>GSS</sub>	Gate-Body Leakage Current	V <sub>GS</sub> =20 V			100	nA
V <sub>GS(th)</sub>	Gate Threshold Voltage	V <sub>DS</sub> = V <sub>GS</sub> , I <sub>D</sub> =250μA	2.5		4.5	V
R <sub>DS(ON)</sub>	Static Drain-Source On-Resistance <sup>2</sup>	V <sub>GS</sub> =10V, I <sub>D</sub> =23A		60	70	mΩ
g <sub>FS</sub>	Forward Transconductance	V <sub>DS</sub> = 40V, I <sub>D</sub> =25A		30		S
<b>DYNAMIC PARAMETERS</b>						
C <sub>iss</sub>	Input Capacitance	V <sub>GS</sub> =0V, V <sub>DS</sub> =25V, f=1MHz		3800		pF
C <sub>oss</sub>	Output Capacitance			215		pF
C <sub>rss</sub>	Reverse Transfer Capacitance			70		pF
<b>SWITCHING PARAMETERS</b>						
Q <sub>g</sub>	Total Gate Charge <sup>2</sup>	V <sub>GS</sub> =10V, V <sub>DD</sub> =480V, I <sub>D</sub> =23A		170		nC
Q <sub>gs</sub>	Gate Source Charge			21		nC
Q <sub>gd</sub>	Gate Drain Charge			87		nC
t <sub>d(on)</sub>	Turn-On Delay Time	V <sub>GS</sub> =13V, V <sub>DS</sub> =480V, R <sub>GEN</sub> =20Ω I <sub>D</sub> =23A		16		ns
t <sub>d(off)</sub>	Turn-Off Delay Time			83		ns
t <sub>d(r)</sub>	Turn-On Rise Time			12		ns
t <sub>d(f)</sub>	Turn-Off Fall Time			5		ns
<b>Source-Drain Diode</b>						
Symbol	Parameter	Test Condition	Min	Typ	Max	Units
I <sub>S</sub>	Drain-Source Diode Forward Current				47	A
I <sub>SM</sub>	Pulse Drain-Source Diode Forward Current				140	A
V <sub>SD</sub>	Diode Forward Voltage	I <sub>F</sub> =23A, V <sub>GS</sub> =0V,		0.9	1.5	V
Q <sub>rr</sub>	Reverse Recovery Charge	dI/dt=100A/μs		19		μC

Typical Characteristics

Power dissipation

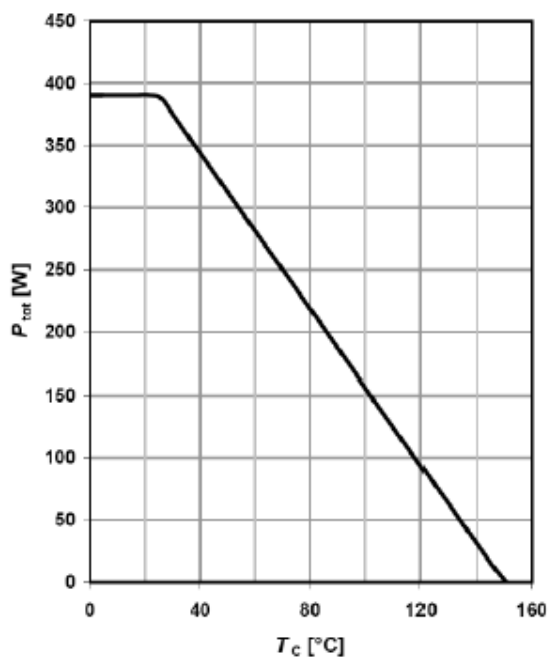

$P_{tot}=f(T_c)$

Safe operating area TC=25 °C

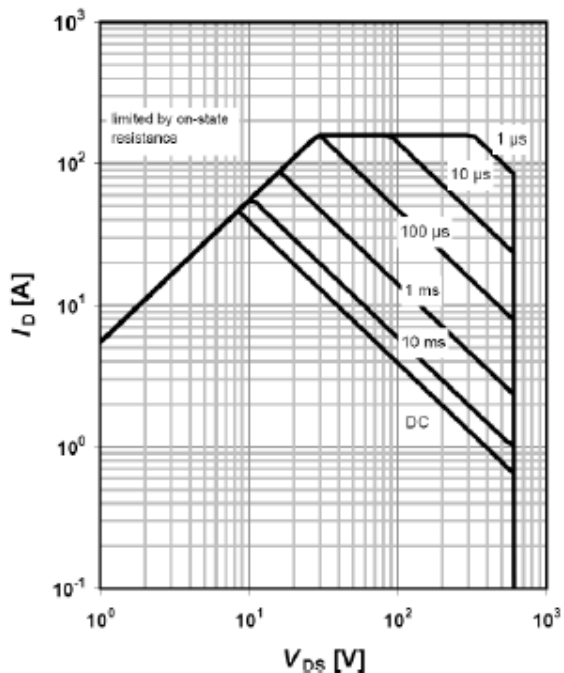

$I_D=f(V_{DS}); T_C=25\text{ °C}; D=0$ ; parameter  $t_p$

Max. transient thermal impedance

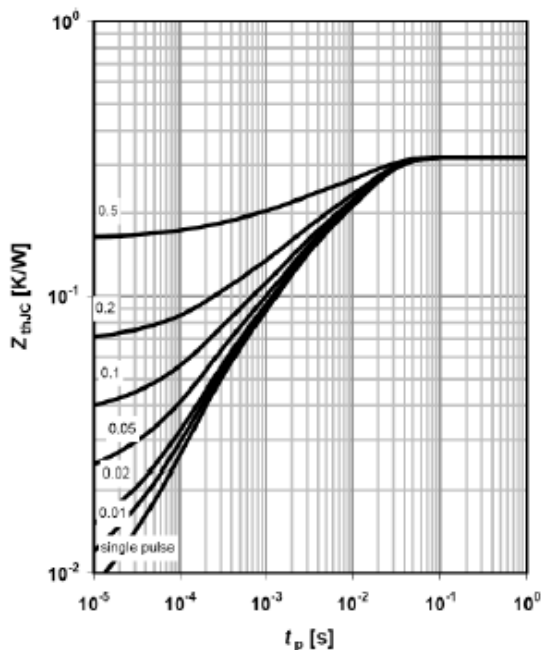

$Z_{(th)C}=f(t_p)$ ; parameter  $D=t_p/T$

Typ. output characteristics  $T_j=25\text{ °C}$

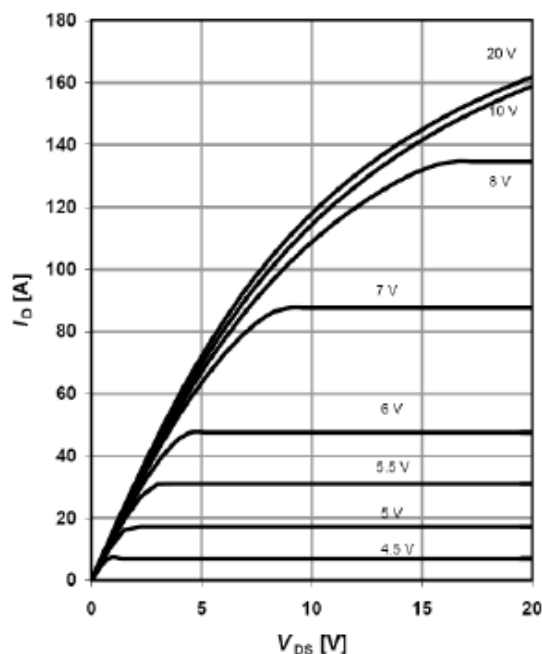

$I_D=f(V_{DS}); T_j=25\text{ °C}$ ; parameter:  $V_{GS}$

# SE47NS65TS

Typ. output characteristics  $T_j=125\text{ }^\circ\text{C}$

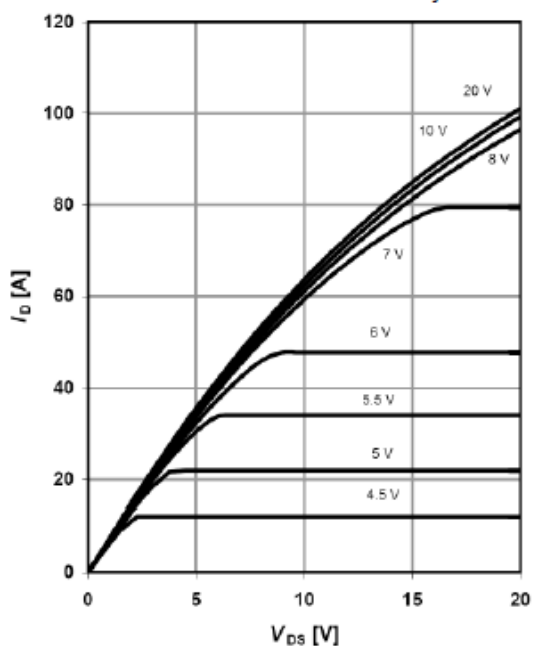

$I_D=f(V_{DS}); T_j=125\text{ }^\circ\text{C}$  ; parameter:  $V_{GS}$

Typ. drain-source on-state resistance

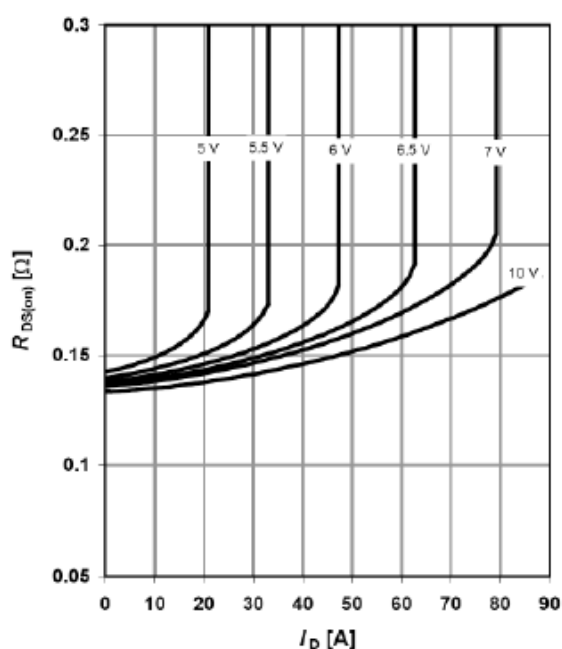

$R_{DS(on)}=f(I_D); T_j=125\text{ }^\circ\text{C}$  ; parameter:  $V_{GS}$

Typ. drain-source on-state resistance

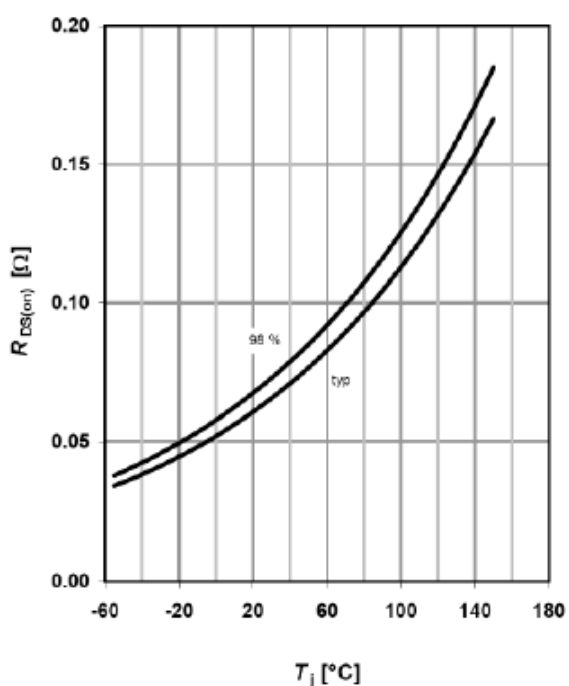

$R_{DS(on)}=f(T_j); I_D=23\text{ A}; V_{GS}=10\text{ V}$

Typ. transfer characteristics

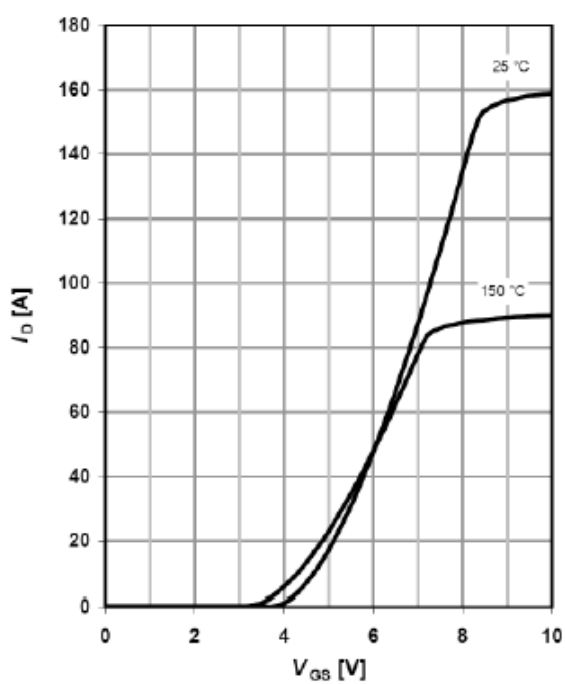

$I_D=f(V_{GS}); V_{DS}=40\text{ V}$

Typ. gate charge

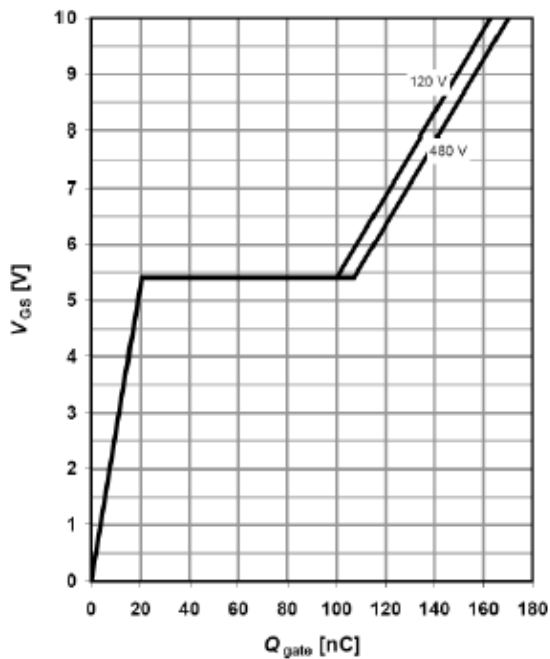

$V_{GS}=f(Q_g), I_D=23A$  pulsed

Avalanche energy

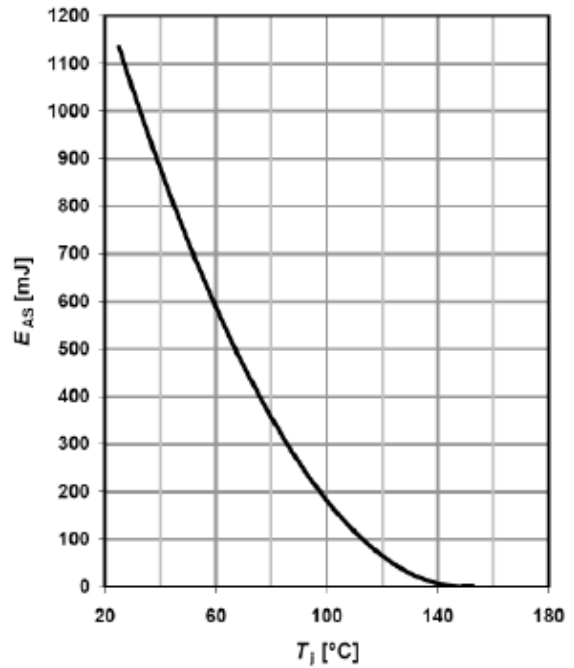

$E_{AS}=f(T_j); I_D=9.3A; V_{DD}=50 V$

Forward characteristics of reverse diode

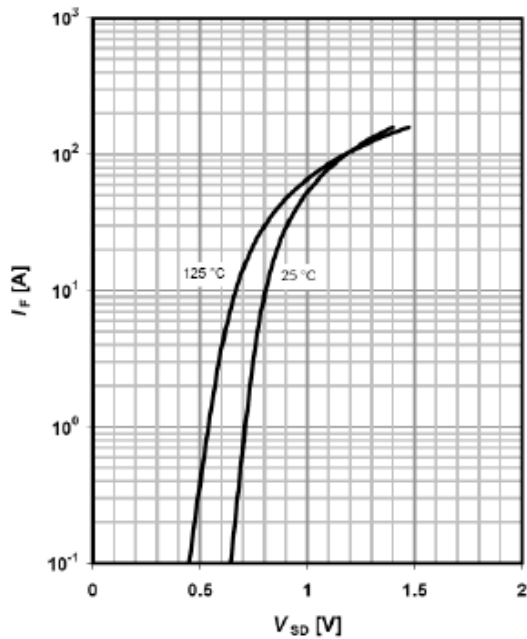

$I_F=f(V_{SD});$  parameter:  $T_j$

Drain-source breakdown voltage

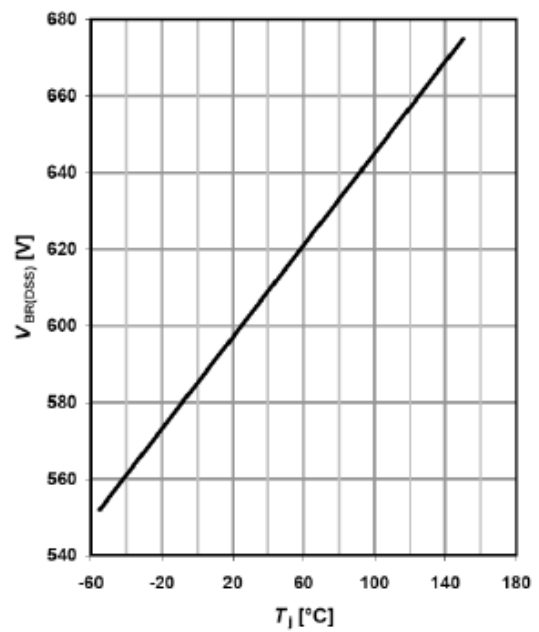

$V_{BR(DSS)}=f(T_j); I_D=0.25mA$

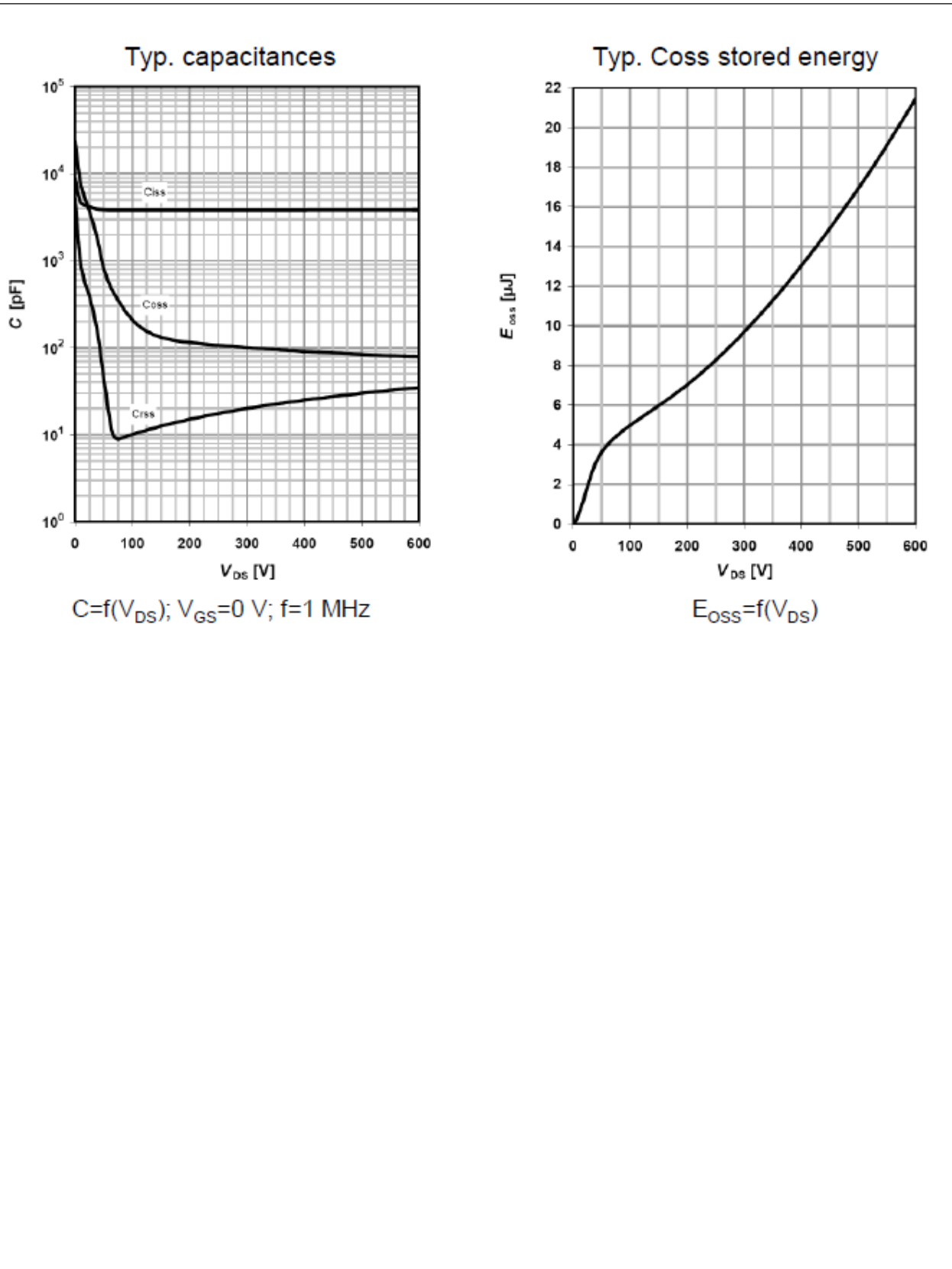

# SE47NS65TS

## Package Outline Dimension

### TO-247S

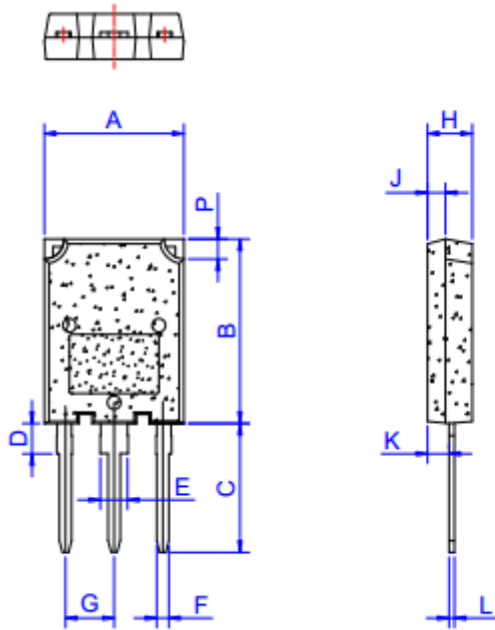

TO-247S

Ref.	Dimensions					
	Millimeters			Inches		
	Min.	Typ.	Max.	Min.	Typ.	Max.
A	15.1		16.1	0.594		0.634
B	19.8		20.8	0.78		0.819
C	13.8		14.8	0.543		0.583
D	3.00		4.00	0.118		0.157
E	2.75		3.35	0.108		0.132
F	1.30		1.50	0.051		0.059
G	5.10		5.80	0.201		0.228
H	4.50		5.50	0.177		0.217
J	1.45		2.15	0.057		0.085
K	1.90		2.80	0.075		0.110
L	0.55		0.80	0.022		0.031
P	2.00		2.40	0.079		0.094