



# SGM803/SGM809/SGM810 Microprocessor Supervisory Circuit in 3-Pin SOT-23

## GENERAL DESCRIPTION

The SGM803/SGM809/SGM810 supervisory circuits monitor the power supply voltage in microprocessor and digital systems. They provide a reset output during power-up, power-down and brownout conditions. On power-up, an internal timer holds reset asserted for 240ms. This holds the microprocessor in a reset state until conditions have stabilized. The  $\overline{\text{RESET}}$  output remains operational with  $V_{CC}$  as low as 1V. The SGM803 and SGM809 provide an active low reset signal ( $\overline{\text{RESET}}$ ) while the SGM810 provides an active high signal (RESET) output. The SGM809/SGM810 have push-pull outputs, whereas the SGM803 has an open-drain output, which requires an external pull-up resistor.

Eight reset threshold voltage options are available, suitable for monitoring 1.8V, 2.5V, 3V, 3.3V and 5V supply voltages.

The reset comparator features built-in glitch immunity, making it immune to fast transients on  $V_{CC}$ .

The low supply current of typically 13 $\mu$ A makes the SGM803/SGM809/SGM810 ideal for use in portable, battery operated equipment. All are specified over the extended -40°C to +125°C temperature range.

## FEATURES

- Precision Voltage Monitor: 1.8V, 2.5V, 3V, 3.3V, 5V Options
- Superior Upgrade for MAX803/MAX809/MAX810 and ADM803/ADM809/ADM810
- Fully Specified over Temperature
- Low Power Consumption: 13 $\mu$ A (TYP)
- Reset Assertion Down to 1V  $V_{CC}$
- 150ms Power-On Reset (MIN)
  - Open-Drain  $\overline{\text{RESET}}$  Output (SGM803)
  - Push-Pull  $\overline{\text{RESET}}$  Output (SGM809)
  - Push-Pull RESET Output (SGM810)
- -40°C to +125°C Operating Temperature Range
- Small Packaging
  - SGM803 Available in SOT-23-3 and SOT-23
  - SGM809 Available in SOT-23-3 and SOT-23
  - SGM810 Available in SOT-23-3 and SOT-23

## APPLICATIONS

Microprocessor Systems  
Controllers  
Intelligent Instruments  
Automotive Systems  
Safety Systems  
Portable Instruments

## TYPICAL APPLICATION

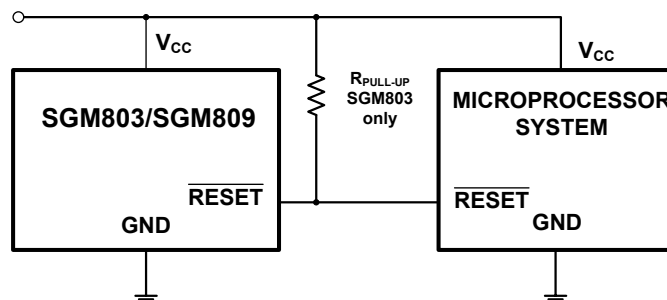

**PACKAGE/ORDERING INFORMATION**

MODEL	RESET THRESHOLD (V)	PACKAGE DESCRIPTION	ORDERING NUMBER	PACKAGE MARKING	PACKING OPTION
SGM803	4.63	SOT-23-3	SGM803-LXN3/TR	803L	Tape and Reel, 3000
	4.63	SOT-23	SGM803-LXN3L/TR	803LL	Tape and Reel, 3000
	4.38	SOT-23-3	SGM803-MXN3/TR	803M	Tape and Reel, 3000
	4.38	SOT-23	SGM803-MXN3L/TR	803ML	Tape and Reel, 3000
	4.00	SOT-23-3	SGM803-JXN3/TR	803J	Tape and Reel, 3000
	4.00	SOT-23	SGM803-JXN3L/TR	803JL	Tape and Reel, 3000
	3.08	SOT-23-3	SGM803-TXN3/TR	803T	Tape and Reel, 3000
	3.08	SOT-23	SGM803-TXN3L/TR	803TL	Tape and Reel, 3000
	2.93	SOT-23-3	SGM803-SXN3/TR	803S	Tape and Reel, 3000
	2.93	SOT-23	SGM803-SXN3L/TR	803SL	Tape and Reel, 3000
	2.63	SOT-23-3	SGM803-RXN3/TR	803R	Tape and Reel, 3000
	2.63	SOT-23	SGM803-RXN3L/TR	803RL	Tape and Reel, 3000
	2.32	SOT-23-3	SGM803-ZXN3/TR	803Z	Tape and Reel, 3000
	2.32	SOT-23	SGM803-ZXN3L/TR	803ZL	Tape and Reel, 3000
	1.63	SOT-23-3	SGM803-XXN3/TR	803X	Tape and Reel, 3000
	1.63	SOT-23	SGM803-XXN3L/TR	803XL	Tape and Reel, 3000
SGM809	4.63	SOT-23-3	SGM809-LXN3/TR	809L	Tape and Reel, 3000
	4.63	SOT-23	SGM809-LXN3L/TR	809LL	Tape and Reel, 3000
	4.38	SOT-23-3	SGM809-MXN3/TR	809M	Tape and Reel, 3000
	4.38	SOT-23	SGM809-MXN3L/TR	809ML	Tape and Reel, 3000
	4.00	SOT-23-3	SGM809-JXN3/TR	809J	Tape and Reel, 3000
	4.00	SOT-23	SGM809-JXN3L/TR	809JL	Tape and Reel, 3000
	3.08	SOT-23-3	SGM809-TXN3/TR	809T	Tape and Reel, 3000
	3.08	SOT-23	SGM809-TXN3L/TR	809TL	Tape and Reel, 3000
	2.93	SOT-23-3	SGM809-SXN3/TR	809S	Tape and Reel, 3000
	2.93	SOT-23	SGM809-SXN3L/TR	809SL	Tape and Reel, 3000
	2.63	SOT-23-3	SGM809-RXN3/TR	809R	Tape and Reel, 3000
	2.63	SOT-23	SGM809-RXN3L/TR	809RL	Tape and Reel, 3000
	2.32	SOT-23-3	SGM809-ZXN3/TR	809Z	Tape and Reel, 3000
	2.32	SOT-23	SGM809-ZXN3L/TR	809ZL	Tape and Reel, 3000
	1.63	SOT-23-3	SGM809-XXN3/TR	809X	Tape and Reel, 3000
	1.63	SOT-23	SGM809-XXN3L/TR	809XL	Tape and Reel, 3000

**PACKAGE/ORDERING INFORMATION (continued)**

MODEL	RESET THRESHOLD (V)	PACKAGE DESCRIPTION	ORDERING NUMBER	PACKAGE MARKING	PACKING OPTION
SGM810	4.63	SOT-23-3	SGM810-LXN3/TR	810L	Tape and Reel, 3000
	4.63	SOT-23	SGM810-LXN3L/TR	810LL	Tape and Reel, 3000
	4.38	SOT-23-3	SGM810-MXN3/TR	810M	Tape and Reel, 3000
	4.38	SOT-23	SGM810-MXN3L/TR	810ML	Tape and Reel, 3000
	4.00	SOT-23-3	SGM810-JXN3/TR	810J	Tape and Reel, 3000
	4.00	SOT-23	SGM810-JXN3L/TR	810JL	Tape and Reel, 3000
	3.08	SOT-23-3	SGM810-TXN3/TR	810T	Tape and Reel, 3000
	3.08	SOT-23	SGM810-TXN3L/TR	810TL	Tape and Reel, 3000
	2.93	SOT-23-3	SGM810-SXN3/TR	810S	Tape and Reel, 3000
	2.93	SOT-23	SGM810-SXN3L/TR	810SL	Tape and Reel, 3000
	2.63	SOT-23-3	SGM810-RXN3/TR	810R	Tape and Reel, 3000
	2.63	SOT-23	SGM810-RXN3L/TR	810RL	Tape and Reel, 3000
	2.32	SOT-23-3	SGM810-ZXN3/TR	810Z	Tape and Reel, 3000
	2.32	SOT-23	SGM810-ZXN3L/TR	810ZL	Tape and Reel, 3000
	1.63	SOT-23-3	SGM810-XXN3/TR	810X	Tape and Reel, 3000
	1.63	SOT-23	SGM810-XXN3L/TR	810XL	Tape and Reel, 3000

Green (RoHS & HSF): SG Micro Corp defines "Green" to mean Pb-Free (RoHS compatible) and free of halogen substances. If you have additional comments or questions, please contact your SGMICRO representative directly.

**ABSOLUTE MAXIMUM RATINGS**

(Typical values are at T<sub>A</sub> = +25°C, unless otherwise noted.)  
V<sub>CC</sub>..... -0.3V to 6V  
RESET,  $\overline{\text{RESET}}$  .....-0.3V to V<sub>CC</sub> + 0.3V  
Input Current, V<sub>CC</sub>..... 20mA  
Output Current, RESET,  $\overline{\text{RESET}}$  .....20mA  
Rate of Rise, V<sub>CC</sub>..... 100V/μs  
Power Dissipation, P<sub>D</sub> @ T<sub>A</sub> = +25°C  
SOT-23-3 ..... 0.4W  
Package Thermal Resistance  
SOT-23-3, θ<sub>JA</sub> ..... 250°C/W  
Junction Temperature..... +150°C  
Storage Temperature Range .....-65°C to +150°C  
Lead Temperature (Soldering, 10s).....+260°C  
ESD Susceptibility  
HBM..... 4000V  
MM..... 400V

**RECOMMENDED OPERATING CONDITIONS**

Operating Temperature Range .....-40°C to +125°C

**OVERSTRESS CAUTION**

Stresses beyond those listed in Absolute Maximum Ratings may cause permanent damage to the device. Exposure to absolute maximum rating conditions for extended periods may affect reliability. Functional operation of the device at any conditions beyond those indicated in the Recommended Operating Conditions section is not implied.

**ESD SENSITIVITY CAUTION**

This integrated circuit can be damaged by ESD if you don't pay attention to ESD protection. SGMICRO recommends that all integrated circuits be handled with appropriate precautions. Failure to observe proper handling and installation procedures can cause damage. ESD damage can range from subtle performance degradation to complete device failure. Precision integrated circuits may be more susceptible to damage because very small parametric changes could cause the device not to meet its published specifications.

**DISCLAIMER**

SG Micro Corp reserves the right to make any change in circuit design, or specifications without prior notice.

**PIN CONFIGURATIONS**

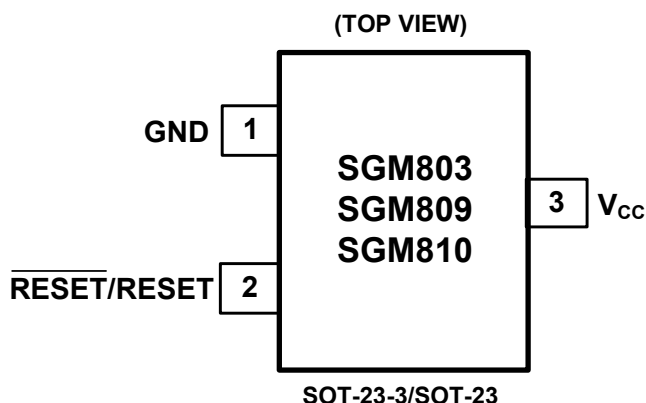

**PIN DESCRIPTION**

NAME	PIN NUMBER			FUNCTION
	SGM803	SGM809	SGM810	
GND	1	1	1	Ground
$\overline{\text{RESET}}$	2	2	—	Active Low Reset (SGM803/SGM809). $\overline{\text{RESET}}$ remains low while $V_{CC}$ is below the reset threshold, and remains low for 240ms (TYP) after $V_{CC}$ rises above the reset threshold.
RESET	—	—	2	Active High Reset (SGM810). RESET remains high while $V_{CC}$ is below the reset threshold, and remains high for 240ms (TYP) after $V_{CC}$ rises above the reset threshold.
$V_{CC}$	3	3	3	Power Supply. Power supply voltage that is monitored.

**ELECTRICAL CHARACTERISTICS**

(V<sub>CC</sub> = 5V for L/M/J Models, 3.3V for T/S Models, 3V for R Models, 2.5V for Z Model, 1.8V for X Model, unless otherwise noted.)

PARAMETER	CONDITIONS	MIN	TYP	MAX	UNITS
<b>SUPPLY</b>					
Voltage	T <sub>A</sub> = 0°C to +70°C	1.0		5.5	V
	T <sub>A</sub> = -40°C to +125°C	1.2		5.5	V
Current	V <sub>CC</sub> < 5.5V, SGM8_L/M/J, T <sub>A</sub> = +25°C		17	30	μA
	V <sub>CC</sub> < 5.5V, SGM8_L/M/J, T <sub>A</sub> = -40°C to +125°C			50	μA
	V <sub>CC</sub> < 3.6V, SGM8_R/S/T/Z/X, T <sub>A</sub> = +25°C		13	25	μA
	V <sub>CC</sub> < 3.6V, SGM8_R/S/T/Z/X, T <sub>A</sub> = -40°C to +125°C			45	μA
<b>RESET VOLTAGE THRESHOLD</b>					
SGM8_L	T <sub>A</sub> = +25°C	4.537	4.63	4.723	V
	T <sub>A</sub> = -40°C to +125°C	4.40		4.86	V
SGM8_M	T <sub>A</sub> = +25°C	4.292	4.38	4.468	V
	T <sub>A</sub> = -40°C to +125°C	4.16		4.56	V
SGM8_J	T <sub>A</sub> = +25°C	3.92	4.00	4.08	V
	T <sub>A</sub> = -40°C to +125°C	3.8		4.2	V
SGM8_T	T <sub>A</sub> = +25°C	3.003	3.08	3.157	V
	T <sub>A</sub> = -40°C to +125°C	2.92		3.23	V
SGM8_S	T <sub>A</sub> = +25°C	2.857	2.93	3.003	V
	T <sub>A</sub> = -40°C to +125°C	2.78		3.08	V
SGM8_R	T <sub>A</sub> = +25°C	2.564	2.63	2.696	V
	T <sub>A</sub> = -40°C to +125°C	2.50		2.76	V
SGM8_Z	T <sub>A</sub> = +25°C	2.262	2.32	2.378	V
	T <sub>A</sub> = -40°C to +125°C	2.22		2.42	V
SGM8_X	T <sub>A</sub> = +25°C	1.589	1.63	1.671	V
	T <sub>A</sub> = -40°C to +125°C	1.55		1.71	V
Reset Threshold Temperature Coefficient			30		ppm/°C
V <sub>CC</sub> to RESET/RESE <sub>T</sub> Delay	V <sub>CC</sub> = V <sub>TH</sub> to (V <sub>TH</sub> - 100mV)		20		μs
Reset Active Timeout Period	T <sub>A</sub> = -40°C to +85°C	150	240	560	ms
	T <sub>A</sub> = -40°C to +125°C	100		840	ms
<b>RESET/RESE<sub>T</sub> OUTPUT VOLTAGE</b>					
Low (SGM803R/S/T/Z/X) Low (SGM809R/S/T/Z/X)	V <sub>CC</sub> = V <sub>TH(MIN)</sub> , I <sub>SINK</sub> = 1.2mA			0.3	V
Low (SGM803L/M/J) Low (SGM809L/M/J)	V <sub>CC</sub> = V <sub>TH(MIN)</sub> , I <sub>SINK</sub> = 3.2mA			0.4	V
Low (SGM803R/S/T/L/M/J/Z/X) Low (SGM809R/S/T/L/M/J/Z/X)	V <sub>CC</sub> > 1.0V, I <sub>SINK</sub> = 50μA			0.3	V
High (SGM809R/S/T/Z/X)	V <sub>CC</sub> > V <sub>TH(MAX)</sub> , I <sub>SOURCE</sub> = 500μA	0.8 × V <sub>CC</sub>			V
High (SGM809L/M/J)	V <sub>CC</sub> > V <sub>TH(MAX)</sub> , I <sub>SOURCE</sub> = 800μA	V <sub>CC</sub> - 1.5			V
Low (SGM810R/S/T/Z/X)	V <sub>CC</sub> = V <sub>TH(MAX)</sub> , I <sub>SINK</sub> = 1.2mA			0.3	V
Low (SGM810L/M/J)	V <sub>CC</sub> = V <sub>TH(MAX)</sub> , I <sub>SINK</sub> = 3.2mA			0.4	V
High (SGM810R/S/T/L/M/J/Z)	1.8V < V <sub>CC</sub> < V <sub>TH(MIN)</sub> , I <sub>SOURCE</sub> = 150μA	0.8 × V <sub>CC</sub>			V
High (SGM810X)	1.2V < V <sub>CC</sub> < V <sub>TH(MIN)</sub> , I <sub>SOURCE</sub> = 150μA	0.8 × V <sub>CC</sub>			V
RESE <sub>T</sub> Open-Drain Output Leakage Current (SGM803)	V <sub>CC</sub> > V <sub>TH</sub> , reset de-asserted			1	μA

TYPICAL PERFORMANCE CHARACTERISTICS

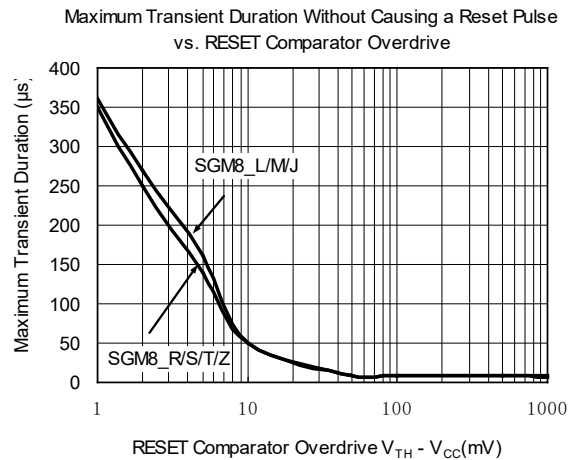
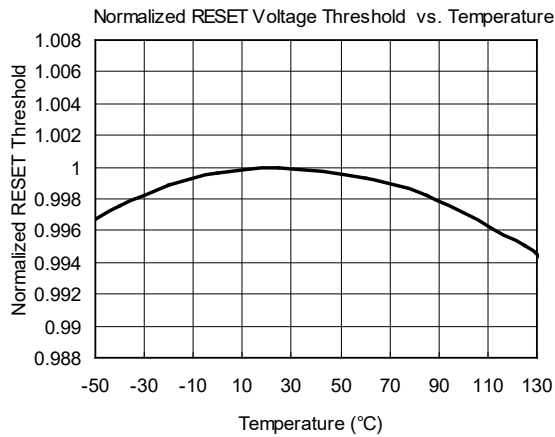
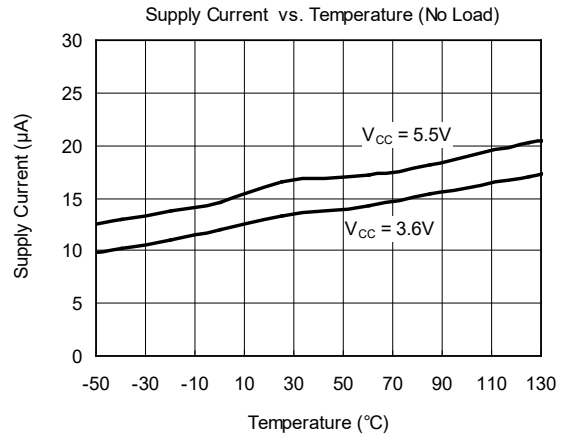
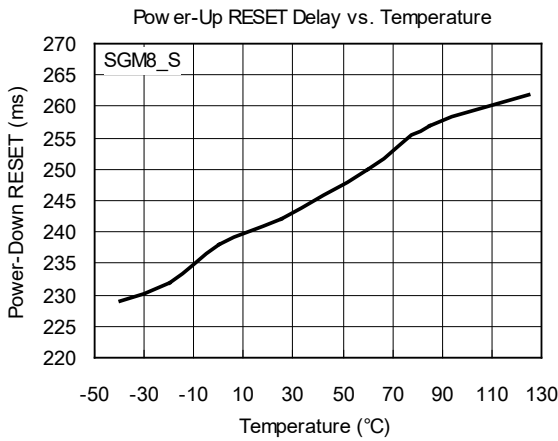
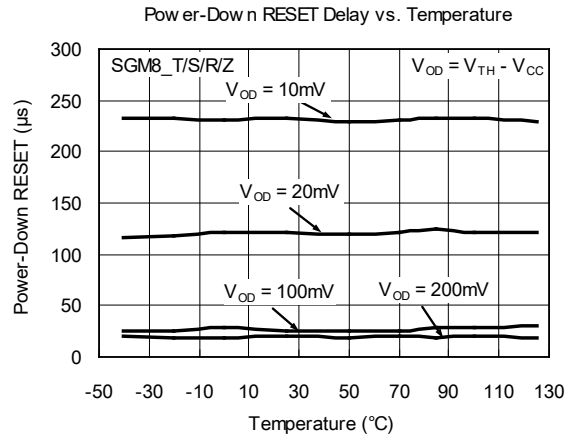
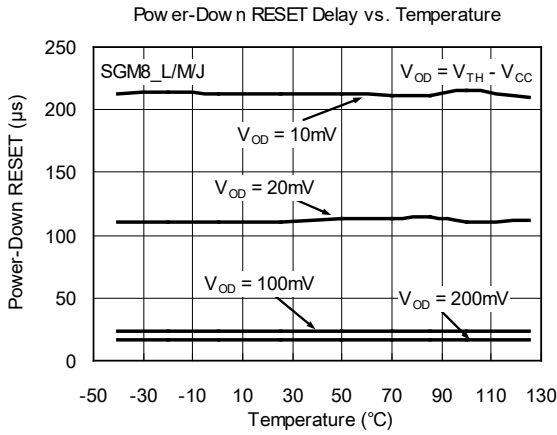

TYPICAL PERFORMANCE CHARACTERISTICS (continued)

RESET Output Voltage vs. Supply Voltage

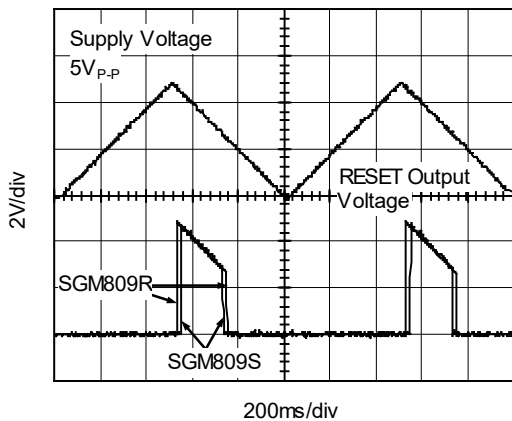

APPLICATION INFORMATION

Benefits of an Accurate Reset Threshold

In other microprocessor supervisory circuits, tolerances in supply voltages lead to an overall increase in reset tolerance levels due to the deterioration of the microprocessor reset circuit's power supply. The possibility of a malfunction during a power failure is greatly reduced because the SGM803/SGM809/SGM810 series can operate effectively even when there are large degradations of the supply voltages. Another advantage of the SGM803/SGM809/SGM810 series is its very accurate internal voltage reference circuit. These benefits combine to produce an exceptionally reliable voltage monitor circuit.

Interfacing to Microprocessors with Multiple Interrupts

In a number of cases, it is necessary to interface many interrupts from different devices (for example, thermal, altitude, and velocity sensors). The SGM803/SGM809/SGM810 can easily be integrated into existing interrupt-handling circuits, as shown in Figure 1, or can be used as a standalone device.

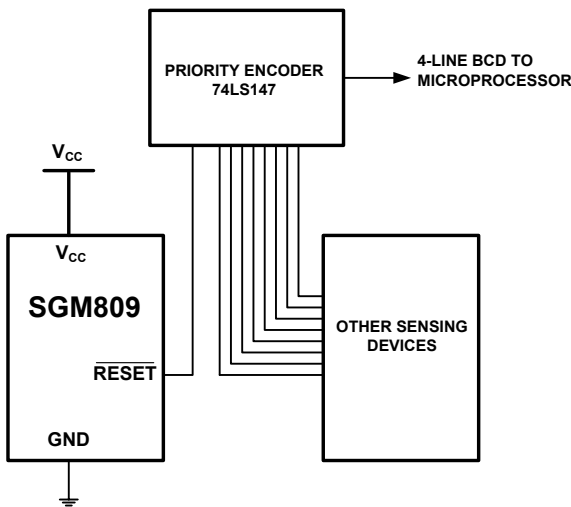

Figure 1. Interfacing to Microprocessors with Multiple Interrupts

Interfacing to Other Devices' Output

The SGM803/SGM809/SGM810 series is designed to integrate with as many devices as possible, therefore, has a standard output dependent on V<sub>CC</sub>. This enables the parts to be used in both 3V and 5V, or any nominal voltage within the minimum and maximum specifications for V<sub>CC</sub>. This design simplifies interfacing this device to other devices.

Ensuring a Valid Reset Output Down to V<sub>CC</sub> = 0V

When V<sub>CC</sub> falls below 1.0V, the SGM803/SGM809  $\overline{\text{RESET}}$  no longer sinks current. A high impedance CMOS logic input connected to  $\overline{\text{RESET}}$  may, therefore, drift to undetermined logic levels. To eliminate this problem, a 100kΩ resistor should be connected from  $\overline{\text{RESET}}$  to ground.

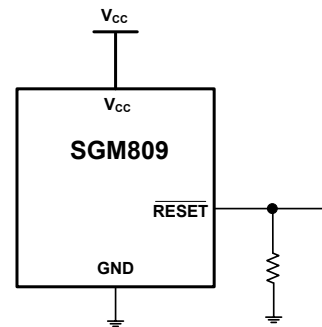

Figure 2. Ensuring a Valid Reset Output Down to V<sub>CC</sub> = 0V

Preventing the High Voltage Spike

To prevent the high voltage spike damage or to limit input V<sub>CC</sub> current, It is recommended to connect a resistor R1 (0Ω to 1kΩ) in series to V<sub>CC</sub>, and one capacitor C1 (0.1μF to 4.7μF) should be connected between V<sub>CC</sub> Pin and GND. The schematic is shown in Figure 3. It must be noted that, the input resistor will affect output driving capability.

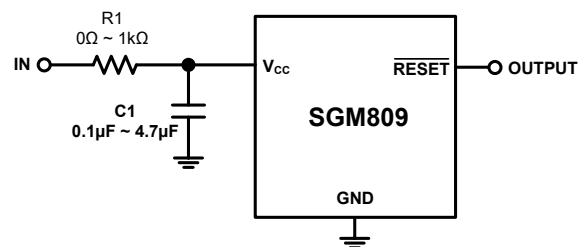

Figure 3. Preventing the High Voltage Spike



DETAILED DESCRIPTIONS

Reset Timing

The reset signal is asserted low for the SGM809 and high for the SGM810 when the power supply voltage falls below the threshold trip voltage and remains asserted for at least 150ms after the power supply voltage has risen above the threshold.

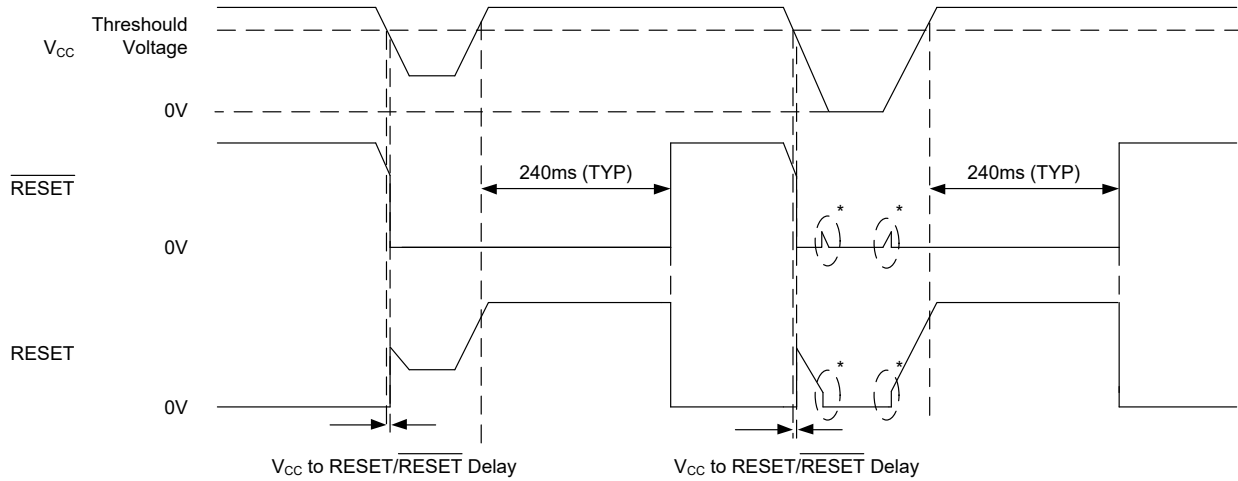

NOTE \*: Undefined below minimum operating voltage.

Figure 4. Reset Timing Diagram

REVISION HISTORY

NOTE: Page numbers for previous revisions may differ from page numbers in the current version.

JANUARY 2018 – REV.E.2 to REV.E.3

Changed Reset Timing Diagram.....9

SEPTEMBER 2015 – REV.E.1 to REV.E.2

Changed Electrical Characteristics section ..... 5

JANUARY 2013 – REV.E to REV.E.1

Added Recommended Land Pattern Information ..... 10, 11

Added Tape and Reel Information..... 12, 13

PACKAGE OUTLINE DIMENSIONS

SOT-23

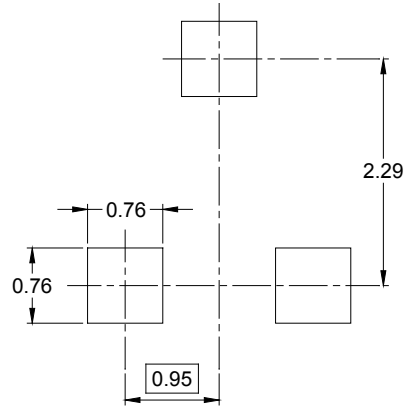
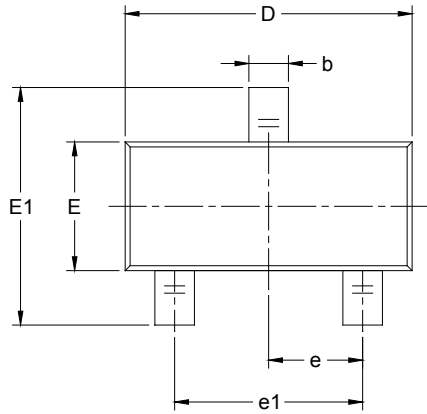

RECOMMENDED LAND PATTERN (Unit: mm)

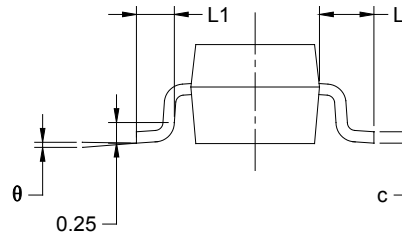
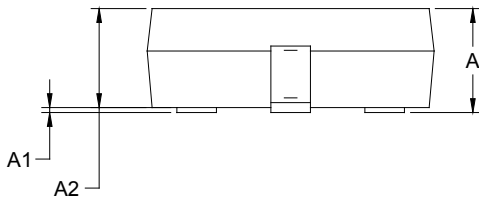

Symbol	Dimensions In Millimeters		Dimensions In Inches	
	MIN	MAX	MIN	MAX
A	0.900	1.150	0.035	0.045
A1	0.000	0.100	0.000	0.004
A2	0.900	1.050	0.035	0.041
b	0.300	0.500	0.012	0.020
c	0.080	0.150	0.003	0.006
D	2.800	3.000	0.110	0.118
E	1.200	1.400	0.047	0.055
E1	2.250	2.550	0.089	0.100
e	0.950 BSC		0.037 BSC	
e1	1.900 BSC		0.075 BSC	
L	0.550 REF		0.022 REF	
L1	0.300	0.500	0.012	0.020
θ	0°	8°	0°	8°

PACKAGE OUTLINE DIMENSIONS

SOT-23-3

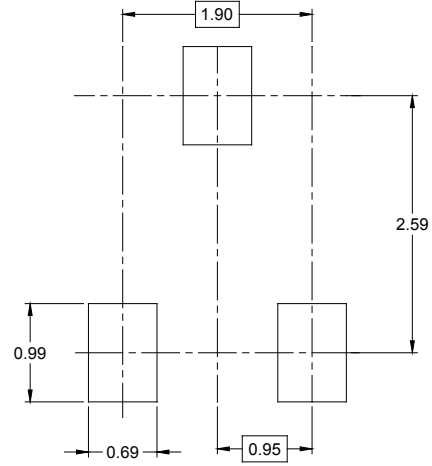
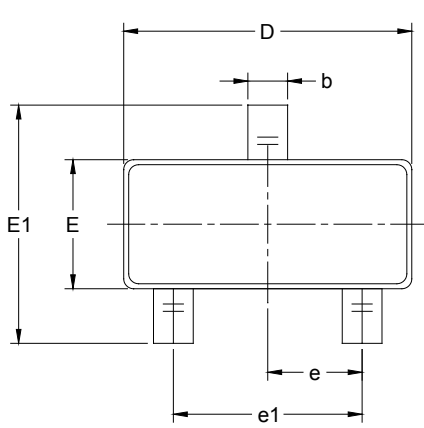

RECOMMENDED LAND PATTERN (Unit: mm)

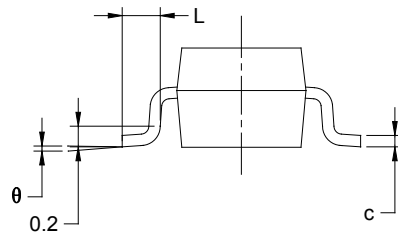
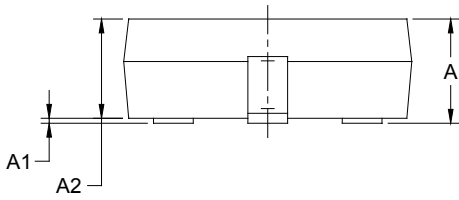

Symbol	Dimensions In Millimeters		Dimensions In Inches	
	MIN	MAX	MIN	MAX
A	1.050	1.250	0.041	0.049
A1	0.000	0.100	0.000	0.004
A2	1.050	1.150	0.041	0.045
b	0.300	0.500	0.012	0.020
c	0.100	0.200	0.004	0.008
D	2.820	3.020	0.111	0.119
E	1.500	1.700	0.059	0.067
E1	2.650	2.950	0.104	0.116
e	0.950 BSC		0.037 BSC	
e1	1.900 BSC		0.075 BSC	
L	0.300	0.600	0.012	0.024
$\theta$	0°	8°	0°	8°

## TAPE AND REEL INFORMATION

### REEL DIMENSIONS



### TAPE DIMENSIONS



NOTE: The picture is only for reference. Please make the object as the standard.

### KEY PARAMETER LIST OF TAPE AND REEL

Package Type	Reel Diameter	Reel Width W1 (mm)	A0 (mm)	B0 (mm)	K0 (mm)	P0 (mm)	P1 (mm)	P2 (mm)	W (mm)	Pin1 Quadrant
SOT-23	7"	9.5	3.15	2.77	1.22	4.0	4.0	2.0	8.0	Q3
SOT-23-3	7"	9.0	3.20	3.30	1.30	4.0	4.0	2.0	8.0	Q3

D00001

# PACKAGE INFORMATION

## CARTON BOX DIMENSIONS



NOTE: The picture is only for reference. Please make the object as the standard.

## KEY PARAMETER LIST OF CARTON BOX

Reel Type	Length (mm)	Width (mm)	Height (mm)	Pizza/Carton
7" (Option)	368	227	224	8
7"	442	410	224	18

DD0002