

36V, 50 μ A I_Q, Peak 200mA Low Dropout Voltage Linear Regulator

General Description

The RT9079 is a low-dropout (LDO) voltage regulators with enable function offering the benefits of high input voltage, low-dropout voltage, low-power consumption, and miniaturized packaging.

The features of low quiescent current and almost zero disable current is ideal for powering the battery equipment to a longer service life. The RT9079 is stable with the ceramic output capacitor over its wide input range from 3.5V to 36V and the entire range of output load current.

Applications

- Portable, Battery Powered Equipments
- Extra Low Voltage Microcontrollers
- Notebook Computers

Pin Configuration

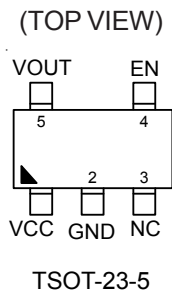

Marking Information

For marking information, contact our sales representative directly or through a Richtek distributor located in your area.

Features

- 50 μ A Ground Current at no Load
- Maximum Operating Input Voltage 36V
- \pm 2% Output Accuracy
- 100mA Continuous Output Current
- Less than 0.1 μ A Disable Current
- Dropout Voltage : 0.2V at 10mA
- Support Fixed Output Voltage 2.5V, 3V, 3.3V, 5V, 6V, 9V, 12V
- Stable with Ceramic or Tantalum Capacitor
- Current Limit Protection
- Over-Temperature Protection
- RoHS Compliant and Halogen Free

Ordering Information

RT9079-	□	□	□	
	Package Type			
	J5 : TSOT-23-5			
	Lead Plating System			
	G : Green (Halogen Free and Pb Free)			
	Output Voltage			
	25 : 2.5V			
	30 : 3V			
	33 : 3.3V			
	50 : 5V			
	60 : 6V			
	90 : 9V			
	C0 : 12V			

Note :

Richtek products are :

- ▶ RoHS compliant and compatible with the current requirements of IPC/JEDEC J-STD-020.
- ▶ Suitable for use in SnPb or Pb-free soldering processes.

Simplified Application Circuit

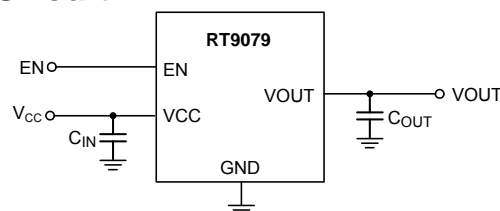

Pin Description

Pin No.	Pin Name	Pin Function
1	VCC	Supply voltage input.
2	GND	Ground.
3	NC	No internal connection.
4	EN	Enable control input.
5	VOUT	Output of the regulator.

Functional Block Diagram

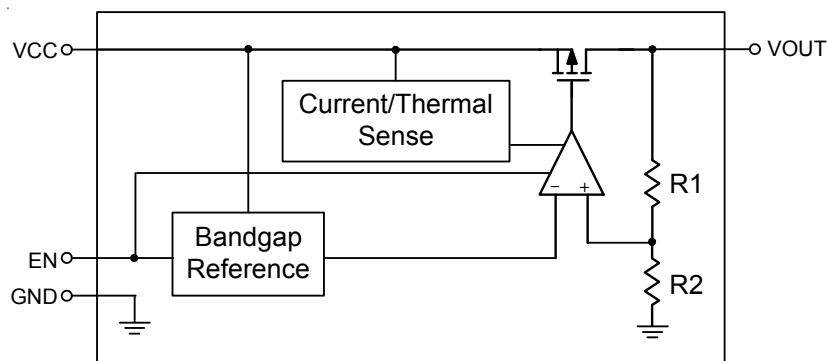

Operation

Basic Operation

The RT9079 is a high input voltage linear regulator designed especially for low external component systems. The input voltage range is from 3.5V to 36V.

The minimum required output capacitance for stable operation is 1 μ F effective capacitance after consideration of the temperature and voltage coefficient of the capacitor.

Output Transistor

The RT9079 builds in a P-MOSFET output transistor which provides a low switch-on resistance for low dropout voltage applications.

Error Amplifier

The Error Amplifier compares the internal reference voltage with the output feedback voltage from the internal divider, and controls the Gate voltage of P-MOSFET to support good line regulation and load regulation at output voltage.

Enable

The RT9079 delivers the output power when it is set to enable state. When it works in disable state, there is no output power and the operation quiescent current is almost zero.

Current Limit Protection

The RT9079 provides current limit function to prevent the device from damages during over-load or shorted-circuit conditions. This current is detected by an internal sensing transistor.

Over-Temperature Protection

The over-temperature protection function turns off the P-MOSFET when the junction temperature exceeds 150°C (typ.) and the output current exceeds 4mA. Once the junction temperature cools down by approximately 20°C, the regulator automatically resumes operation.

Absolute Maximum Ratings (Note 1)

- VCC, EN to GND ----- -0.3V to 40V
- VOUT to VCC ----- -40V to 0.3V
- VOUT to GND
 RT9079-60, RT9079-90/RT9079-C0 ----- -0.3V to 15V
 RT9079-25/RT9079-30/RT9079-33/RT9079-50 ----- -0.3V to 6V
- Power Dissipation, P_D @ T_A = 25°C
 TSOT-23-5 ----- 0.43W
- Package Thermal Resistance (Note 2)
 TSOT-23-5, θ_{JA} ----- 230.6°C/W
- Junction Temperature ----- 150°C
- Lead Temperature (Soldering, 10 sec.) ----- 260°C
- Storage Temperature Range ----- -60°C to 150°C
- ESD Susceptibility (Note 3)
 HBM (Human Body Model) ----- 2kV

Recommended Operating Conditions (Note 4)

- Supply Input Voltage ----- 3.5V to 36V
- Junction Temperature Range ----- -40°C to 125°C
- Ambient Temperature Range ----- -40°C to 85°C

Electrical Characteristics

(C_{IN} = 1μF, T_A = 25°C, unless otherwise specified)

Parameter	Symbol	Test Conditions	Min	Typ	Max	Unit
Supply Voltage	V _{CC}		3.5	--	36	V
Output Voltage Range	V _{OUT}		2.5	--	12	V
DC Output Accuracy	ΔV _{OUT}	I _{LOAD} = 10mA	-2	--	2	%
Dropout Voltage	V _{DROP}	I _{LOAD} = 10mA, V _{CC} > 5V	--	0.2	0.36	V
VCC Consumption Current	I _Q	I _{LOAD} = 0mA, V _{CC} = 15V	--	50	100	μA
Shutdown Current		V _{EN} = 0V	--	0.1	0.5	μA
Shutdown Leakage Current		V _{EN} = 0V, V _{OUT} = 0V	--	0.1	0.5	μA
EN Input Current	I _{EN}	V _{EN} = 36V	--	0.1	--	μA
Line Regulation	ΔV _{LINE}	I _{LOAD} = 1mA, V _{OUT} +1 < V _{CC} < 36V, V _{OUT} > 3.3V	--	0.04	0.5	%
		I _{LOAD} = 1mA, V _{OUT} +1 < V _{CC} < 36V, V _{OUT} ≤ 3.3V	--	0.04	0.6	
Load Regulation	ΔV _{LOAD}	0mA < I _{LOAD} < 100mA	-1	--	1	%
Output Current Limit	I _{LIM}	V _{OUT} = 0.5 x V _{OUT(normal)}	200	350	--	mA
Enable Input Voltage	Logic-High	V _{IH}	--	--	2	V
	Logic-Low	V _{IL}	0.6	--	--	
Thermal Shutdown Temperature	T _{SD}	I _{LOAD} = 30mA	--	150	--	°C
Thermal Shutdown Hysteresis	ΔT _{SD}		--	20	--	°C

Note 1. Stresses beyond those listed under “Absolute Maximum Ratings” may cause permanent damage to the device. These are stress ratings only, and functional operation of the device at these or any other conditions beyond those indicated in the operational sections of the specifications is not implied. Exposure to absolute maximum rating conditions may affect device reliability.

Note 2. θ_{JA} is measured at $T_A = 25^\circ\text{C}$ on a high effective thermal conductivity four-layer test board per JEDEC 51-7.

Note 3. Devices are ESD sensitive. Handling precaution is recommended.

Note 4. The device is not guaranteed to function outside its operating conditions.

Typical Application Circuit

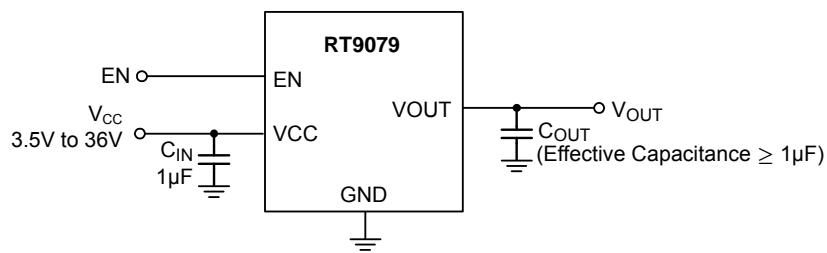

Note 1 : All the input and output capacitances are the suggested values, which refer to the effective capacitances, and are subject to any de-rating effect, like a DC bias.

Typical Operating Characteristics

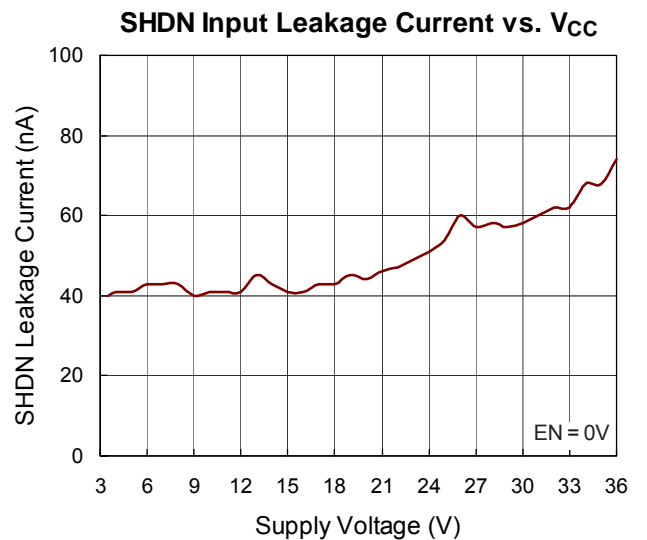
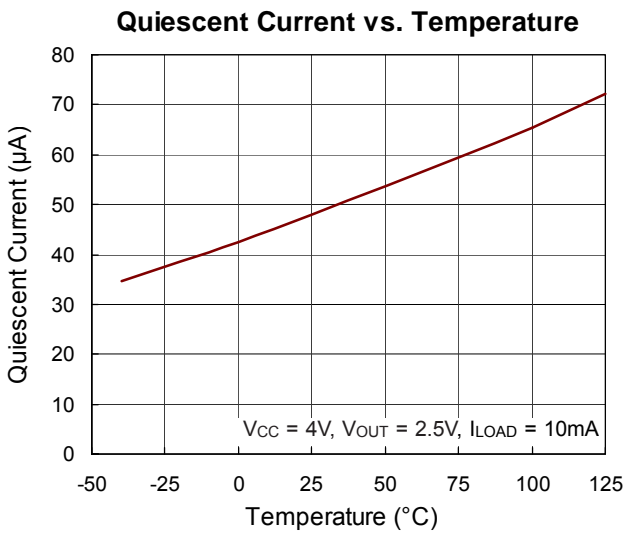
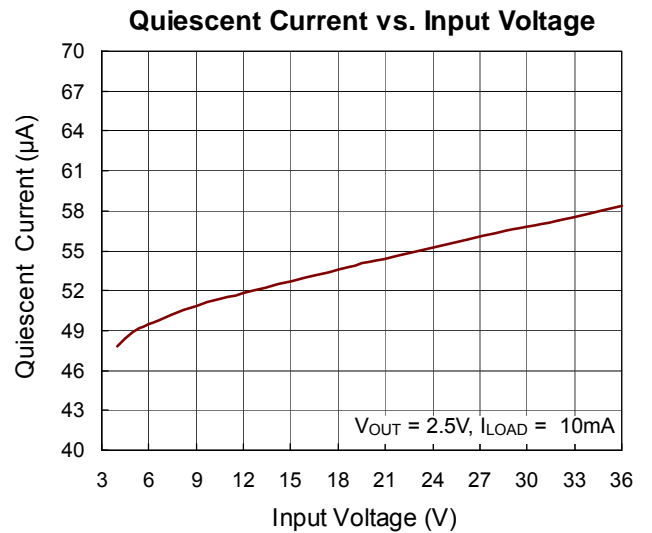
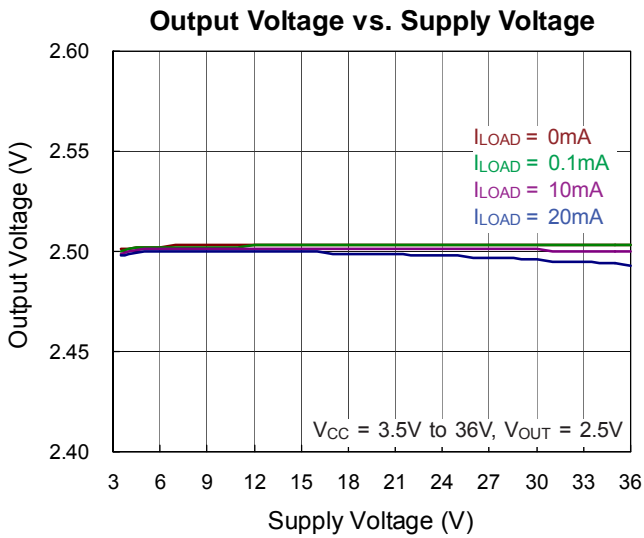
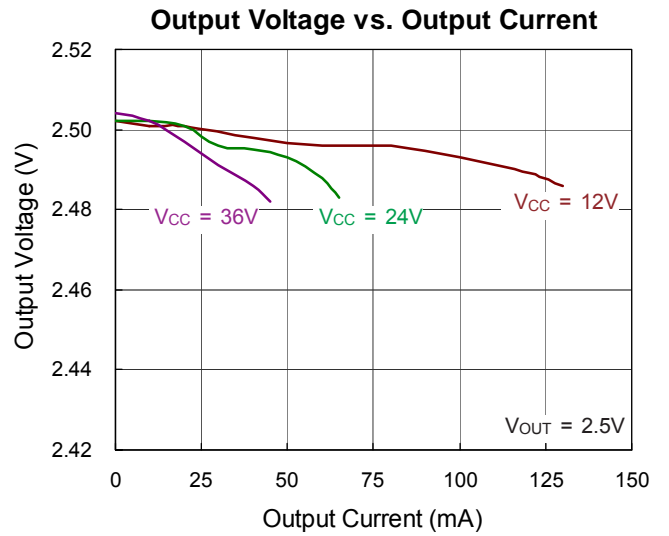
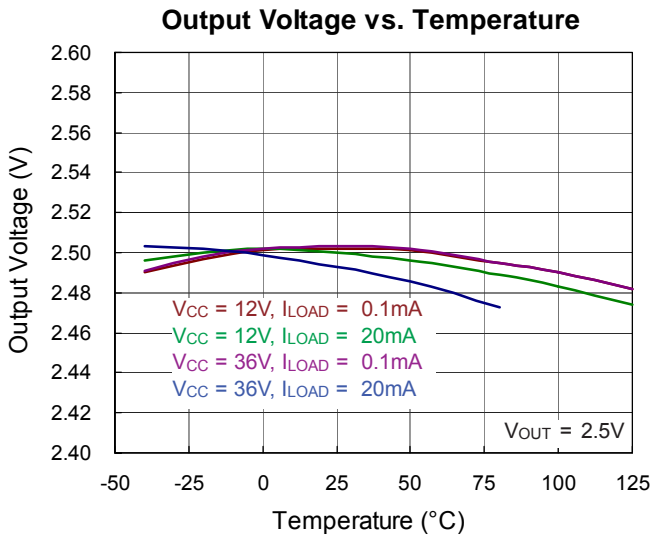

SHDN Input Leakage Current vs. Temperature

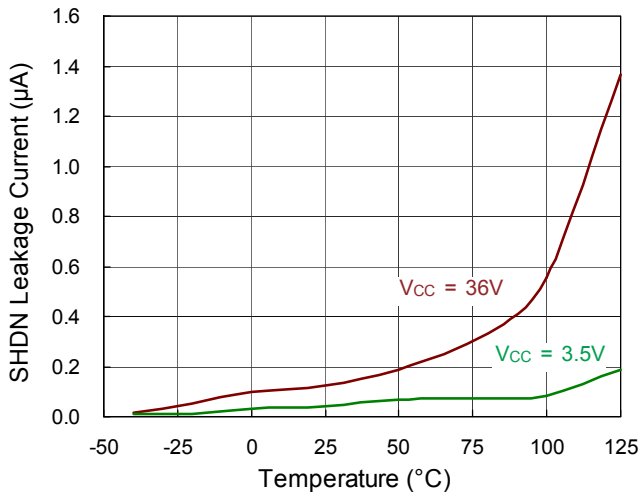

EN Voltage vs. Supply Voltage

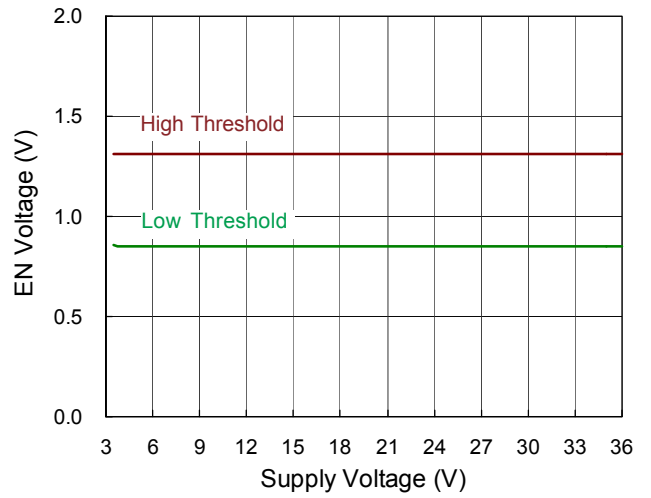

EN Voltage vs. Temperature

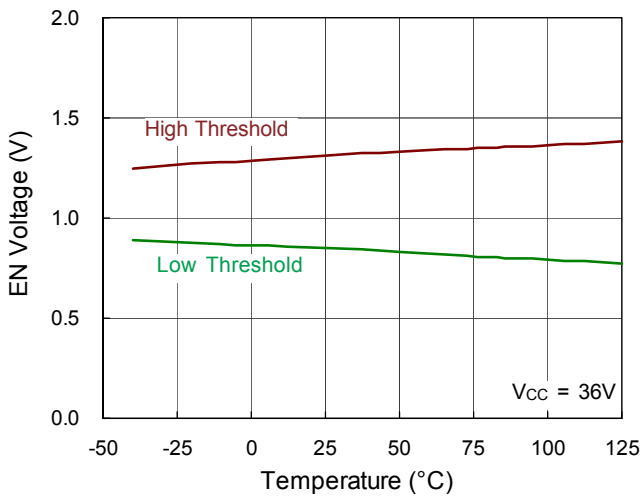

Dropout Voltage vs. Temperature

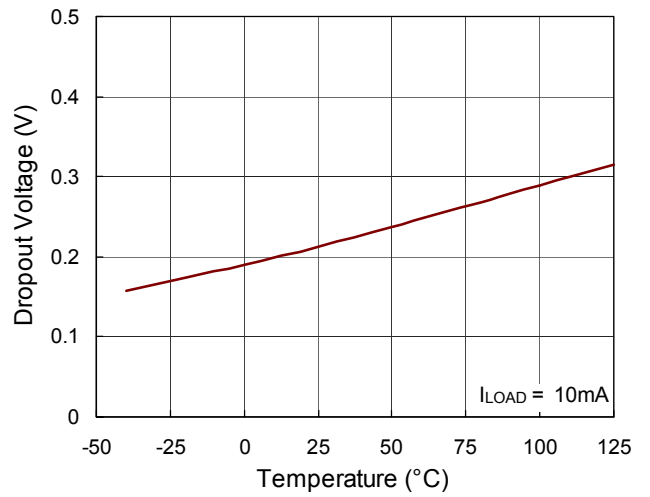

Current Limit vs. Temperature

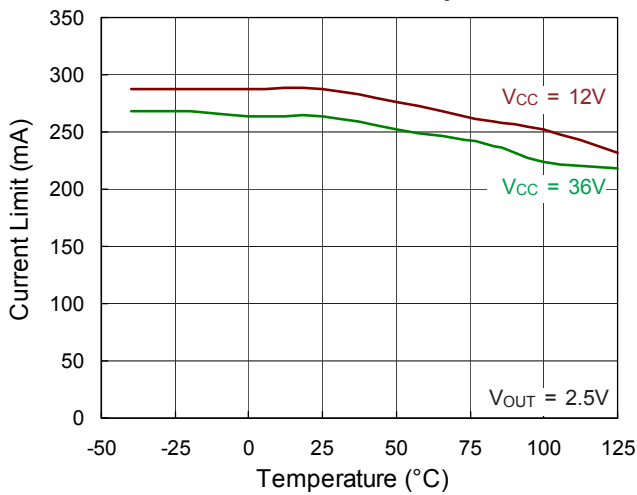

PSRR vs. Frequency

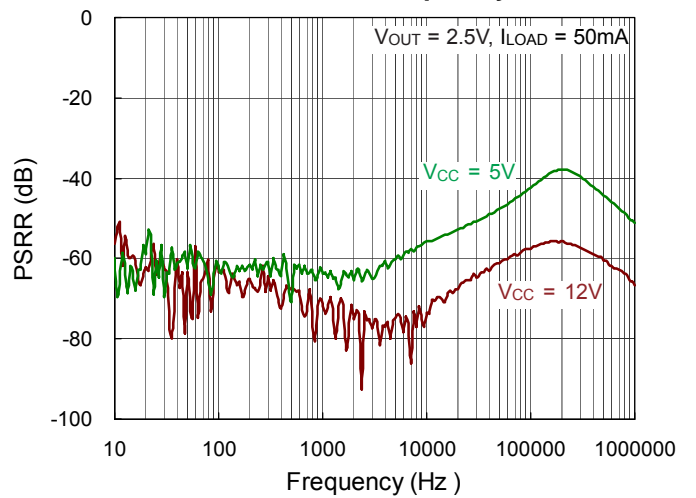

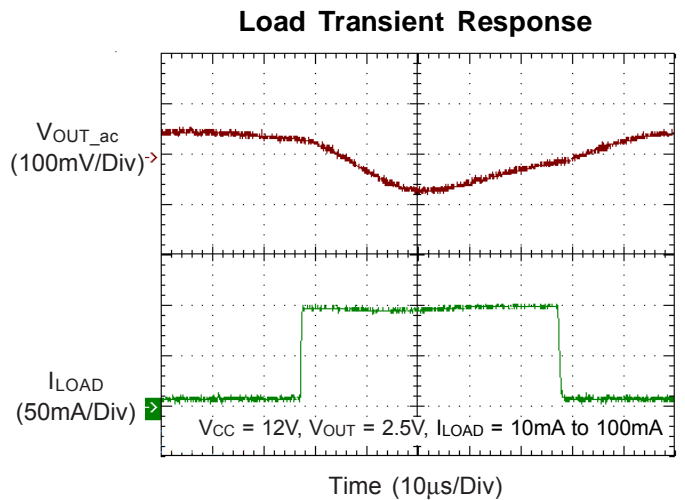
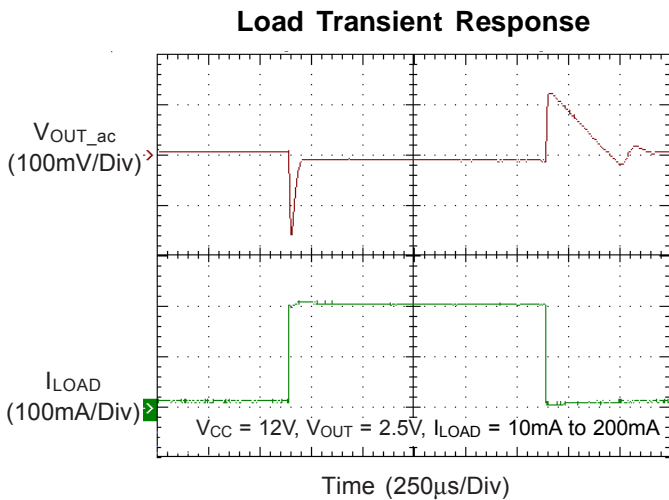
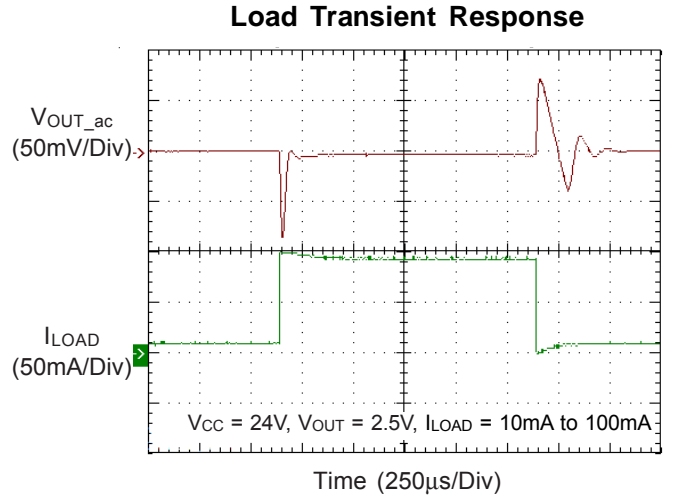
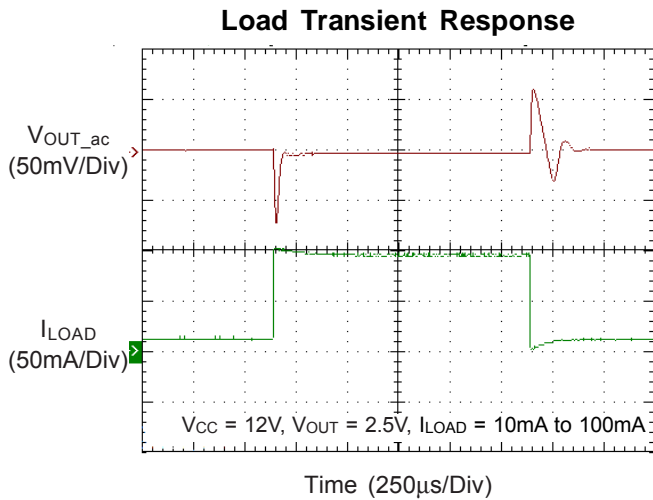
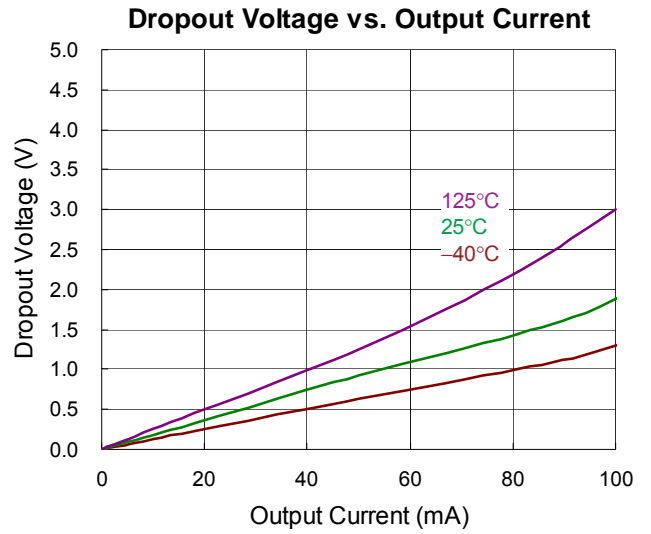
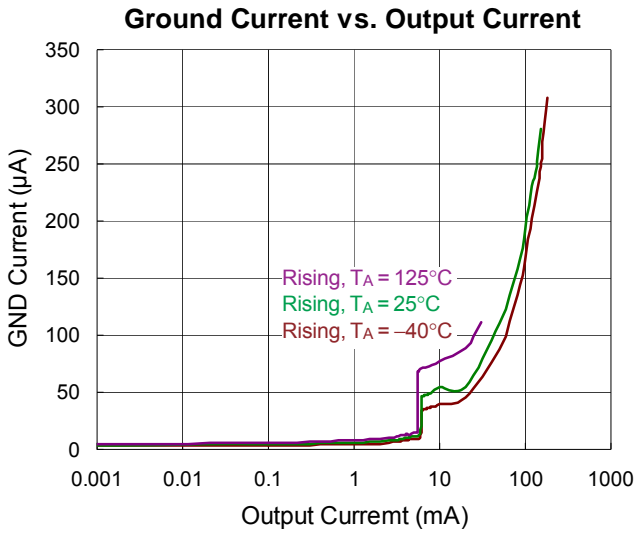

Line Transient Response

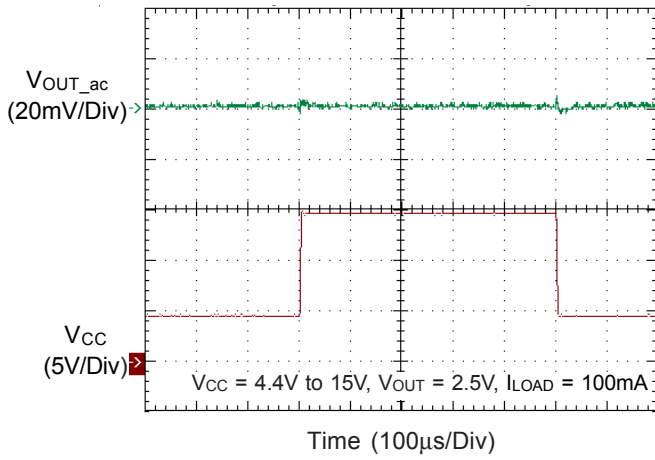

Line Transient Response

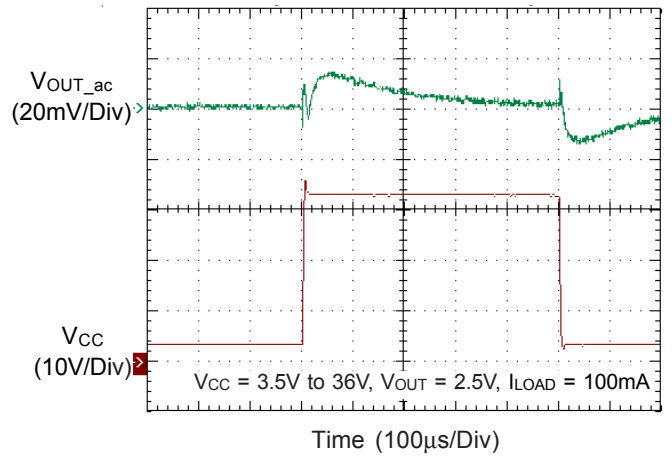

Power On from EN

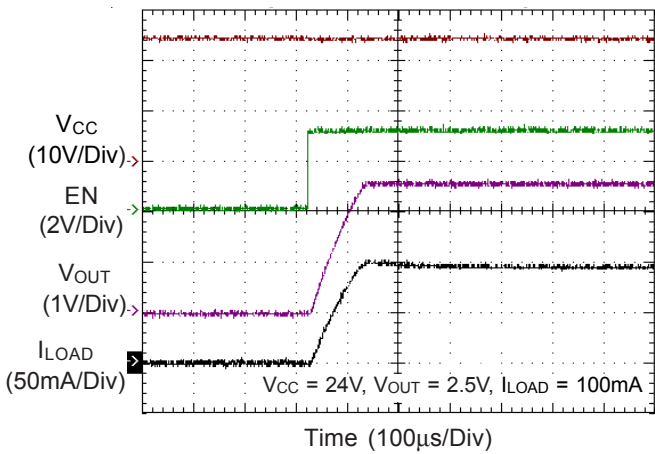

Power Off from EN

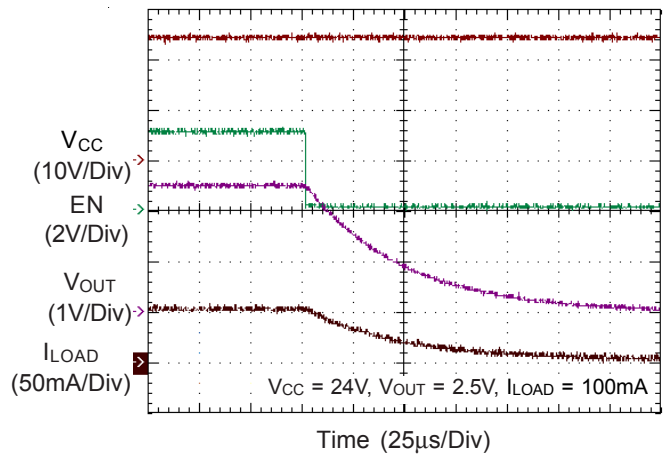

Applications Information

Thermal Considerations

For continuous operation, do not exceed absolute maximum junction temperature. The maximum power dissipation depends on the thermal resistance of the IC package, PCB layout, rate of surrounding airflow, and difference between junction and ambient temperature. The maximum power dissipation can be calculated by the following formula :

$$P_{D(MAX)} = (T_{J(MAX)} - T_A) / \theta_{JA}$$

where $T_{J(MAX)}$ is the maximum junction temperature, T_A is the ambient temperature, and θ_{JA} is the junction to ambient thermal resistance.

For recommended operating condition specifications, the maximum junction temperature is 125°C. The junction to ambient thermal resistance, θ_{JA} , is layout dependent. For TSOT-23-5 package, the thermal resistance, θ_{JA} , is 230.6°C/W on a standard JEDEC 51-7 four-layer thermal test board. The maximum power dissipation at $T_A = 25^\circ\text{C}$ can be calculated by the following formula :

$$P_{D(MAX)} = (125^\circ\text{C} - 25^\circ\text{C}) / (230.6^\circ\text{C/W}) = 0.43\text{W for TSOT-23-5 package}$$

The maximum power dissipation depends on the operating ambient temperature for fixed $T_{J(MAX)}$ and thermal resistance, θ_{JA} . The derating curve in Figure 1 allows the designer to see the effect of rising ambient temperature on the maximum power dissipation.

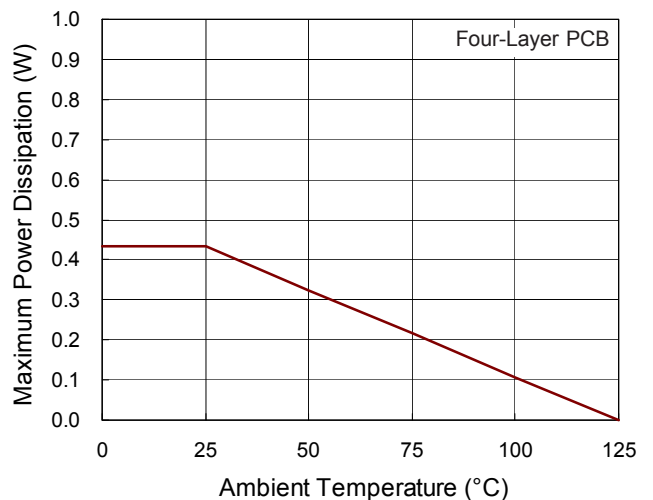
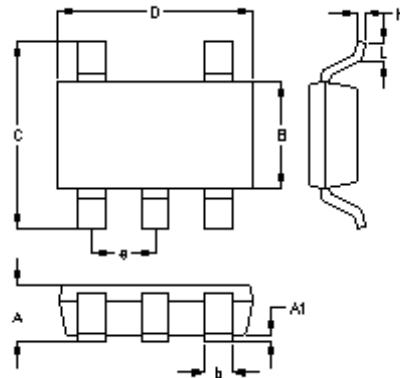

Figure 1. Derating Curve of Maximum Power Dissipation

Outline Dimension



Symbol	Dimensions In Millimeters		Dimensions In Inches	
	Min	Max	Min	Max
A	0.700	1.000	0.028	0.039
A1	0.000	0.100	0.000	0.004
B	1.397	1.803	0.055	0.071
b	0.300	0.559	0.012	0.022
C	2.591	3.000	0.102	0.118
D	2.692	3.099	0.106	0.122
e	0.838	1.041	0.033	0.041
H	0.080	0.254	0.003	0.010
L	0.300	0.610	0.012	0.024

TSOT-23-5 Surface Mount Package

Richtek Technology Corporation

14F, No. 8, Tai Yuen 1st Street, Chupei City
 Hsinchu, Taiwan, R.O.C.
 Tel: (8863)5526789

Richtek products are sold by description only. Customers should obtain the latest relevant information and data sheets before placing orders and should verify that such information is current and complete. Richtek cannot assume responsibility for use of any circuitry other than circuitry entirely embodied in a Richtek product. Information furnished by Richtek is believed to be accurate and reliable. However, no responsibility is assumed by Richtek or its subsidiaries for its use; nor for any infringements of patents or other rights of third parties which may result from its use. No license is granted by implication or otherwise under any patent or patent rights of Richtek or its subsidiaries.