

1.2MHz, 30V, Step-Up Converter

Features

- 2.5V to 5.5V Input Voltage
- 1.23V Feedback Voltage
- 1.2MHz Fixed Switching Frequency
- Internal 0.6A Switch Current Limit
- Internal Compensation
- Thermal Shutdown
- Available in a 5-pin SOT-23 package

Applications

- Camera Flash White LED
- Digital still cameras
- PDA LED back light

General Description

The Y3750 is a step-up converter. Its 1.23V feedback voltage reduces power loss and improves efficiency. Optimized operation frequency can meet the requirement of small LC filters value and low operation current with high efficiency. Internal soft start function can reduce the inrush current. Tiny package type provides the best solution for PCB space saving and total BOM cost.

Typical Application Circuit

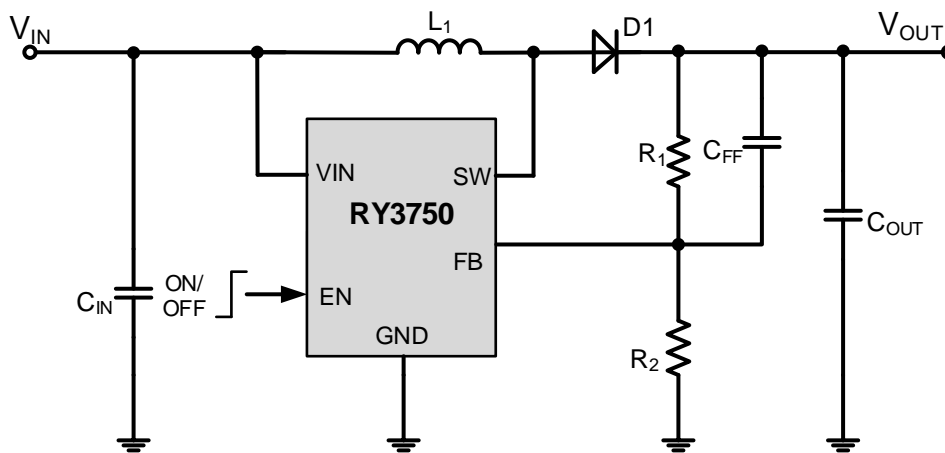
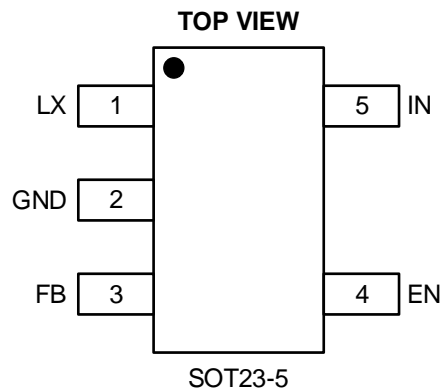

Figure1. Basic Application Circuit

1.2MHz, 30V, Step-Up Converter

Package and Pin Description



Top Marking: KFYLL (device code: KF, Y=year code, LL= lot number code)

Pin	Name	Function
1	LX	Power Switch Output. LX is the drain of the internal MOSFET switch. Connect the power inductor and output rectifier to LX. LX can swing between GND and 30V.
2	GND	Ground Pin
3	FB	Feedback Input. The FB voltage is 1.23V. Connect a resistor divider to FB.
4	EN	Regulator On/Off Control Input. A high input at EN turns on the converter, and a low input turns it off. When not used, connect EN to the input supply for automatic startup.
5	IN	Input Supply Pin. Must be locally bypassed.

Order Information

Marking	Part No.	Model	Description	Package	T/R Qty
<u>KFYLL</u>	70390005	RY3750	RY3750 Step-up Converter, 2.5-5.5V, Vout 30V, 1.2MHz, SOT23-5	SOT23-5	3000PCS

1.2MHz, 30V, Step-Up Converter

Absolute Maximum Ratings

Parameter	Absolute Maximum Ratings	Unit
V_{IN}, V_{EN}	-0.3 to 6	V
V_{SW}	-0.3 to 30	V
All Other Pins	-0.3 to 6	V
Continuous Power Dissipation($T_A=+25^{\circ}C$)	0.6	W
Junction Temperature	150	$^{\circ}C$
Operating Temperature Range	-40 to 85	$^{\circ}C$
Lead Temperature	260	$^{\circ}C$
Storage Temperature	-65 to 150	$^{\circ}C$
Thermal Resistance θ_{JA}	250	$^{\circ}C/W$
Thermal Resistance θ_{JC}	130	$^{\circ}C/W$

Recommended Operating Conditions

Parameter	Recommended	Unit
Supply Voltage V_{IN}	2.5 to 5.5	V
Output Voltage V_{OUT}	V_{IN} to 30	V
Operating Junction Temp.(T_J)	-40 to 125	$^{\circ}C$

Electrical Characteristics

Parameter	Symbol	Test Conditions	Min	Typ	Max	Unit
Supply Current(Shutdown)	I_{IN}	$V_{EN}=0V$		0.1	1	μA
Quiescent Current		$V_{FB}=1V$, switch		0.15	0.3	mA
SW Leakage		$V_{SW} = 20V$			1	μA
SW On Resistance				400	650	m Ω
Operating Input Voltage			2.5		5.5	V
Current Limit	I_{LIMIT}	$V_{IN}= 4V$, Duty cycle=50%		0.6		A
Oscillator Frequency	f_{SW}			1.2		MHz
Maximum Duty Cycle	D_{MAX}	$V_{FB}=1V$		90		%
Feedback Voltage	V_{FB}		1.21	1.23	1.25	V
FB Input Bias Current		$V_{FB}=1.23V$	-50	-10		nA
EN Threshold	V_{EN}			1		V
Thermal Shutdown				160		$^{\circ}C$
Supply Current(Shutdown)	I_{IN}	$V_{EN}=0V$		0.1	1	μA

1.2MHz, 30V, Step-Up Converter

Typical Performance Characteristics

Note (1): Performance waveforms are tested on the evaluation board.

Note (2): $V_{IN}=5V$, $V_{OUT}=24V$, $L = 10\mu H$, $C_{OUT}=22\mu F$ $T_A = +25^\circ C$, unless otherwise noted

Efficiency vs Output Current

$V_{OUT} = 24V$

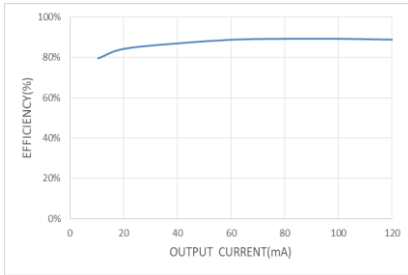

Load Regulation

$V_{OUT} = 24V$

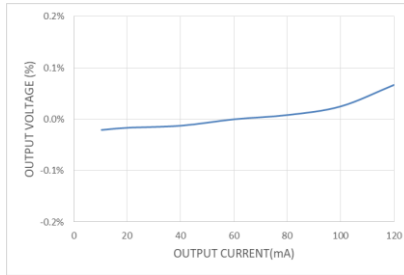

Line Regulation

$V_{OUT} = 24V$, $I_{OUT} = 60mA$

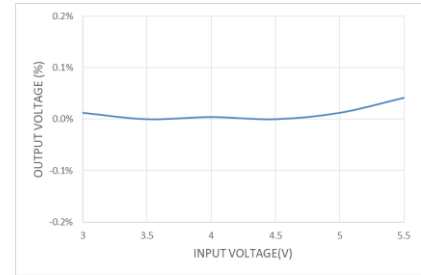

Current Limit vs Duty

$V_{IN}=5V$

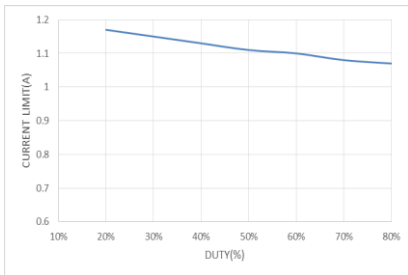

Output Ripple Voltage

$I_{OUT} = 0mA$

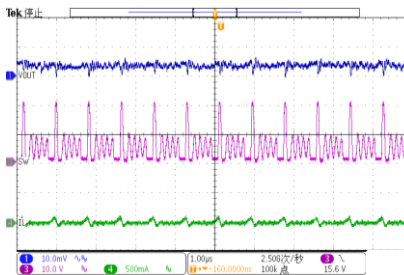

Output Ripple Voltage

$I_{OUT} = 60mA$

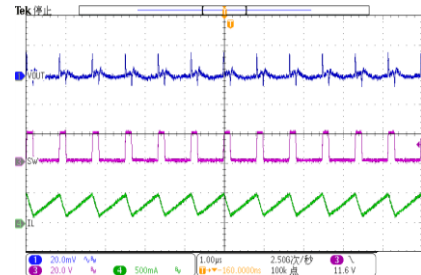

Output Ripple Voltage

$I_{OUT} = 120mA$

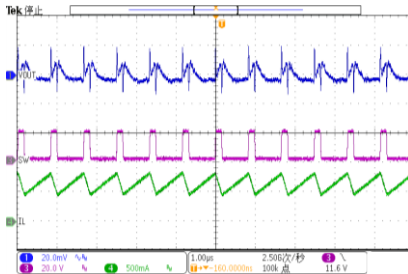

V_{IN} Power On

$I_{OUT} = 60mA$

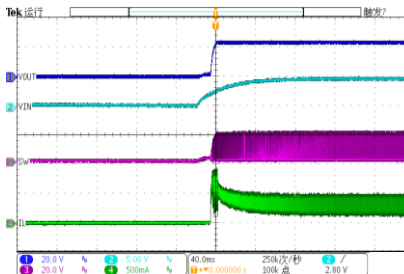

V_{IN} Power Off

$I_{OUT} = 60mA$

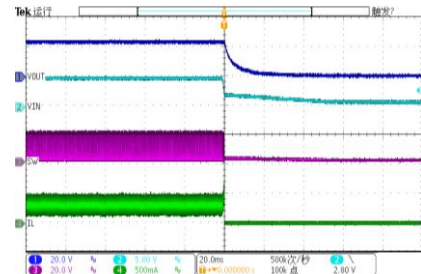

1.2MHz, 30V, Step-Up Converter

EN Power On

$I_{OUT} = 60\text{mA}$

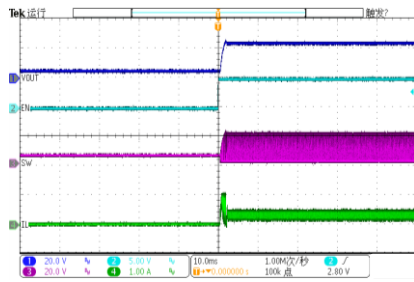

EN Power Off

$I_{OUT} = 60\text{mA}$

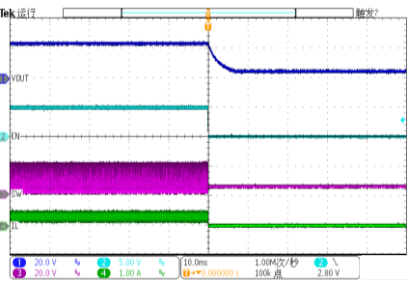

Load Transient

$V_{IN} = 5\text{V}$, $I_{OUT} = 50\text{mA}$ to 100mA @ $300\text{mA}/\mu\text{s}$

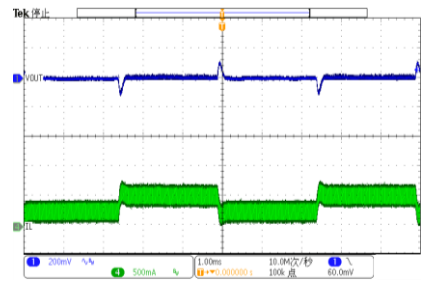

1.2MHz, 30V, Step-Up Converter

Application Information

Setting the Output Voltage

The internal reference VREF is 1.23V (Typical). The output voltage is divided by a resistor divider, R1 and R2 to the FB pin. The output voltage is given by

$$R_2 = \frac{R_1}{V_{OUT} / V_{FB} - 1}$$

Inductor Selection

The recommended values of inductor are 2.2μH to 10μH. Small size and better efficiency are the major concerns for portable device, such as RY3750 used for mobile phone. The inductor should have low core loss at 1.2MHz and low DCR for better efficiency. To avoid inductor saturation current rating should be considered.

Capacitor Selection

Input and output ceramic capacitors of 22μF are recommended for RY3750 applications. For better voltage filtering, ceramic capacitors with low ESR are recommended. X5R and X7R types are suitable because of their wider voltage and temperature ranges.

Diode Selection

Schottky diode is a good choice for RY3750 because of its low forward voltage drop and fast reverses recovery. Using Schottky diode can get better efficiency. The high speed rectification is also a good characteristic of Schottky diode for high switching frequency. Current rating of the diode must meet the root mean square of the peak current and output average current multiplication as following:

$$I_D (RMS) \approx \sqrt{I_{OUT} \times I_{PEAK}}$$

The diode's reverse breakdown voltage should be larger than the output voltage.

Layout Consideration

For best performance of the RY3750, the following guidelines must be strictly followed.

- 1、 Input and Output capacitors should be placed close to the IC and connected to ground plane to reduce noise coupling.
- 2、 The GND should be connected to a strong ground plane for heat sinking and noise protection.
- 3、 Keep the main current traces as possible as short and wide.
- 4、 LX node of DC-DC converter is with high frequency voltage swing. It should be kept at a small area.
- 5、 Place the feedback components as close as possible to the IC and keep away from the noisy devices.

1.2MHz, 30V, Step-Up Converter

Package Description

SOT23-5

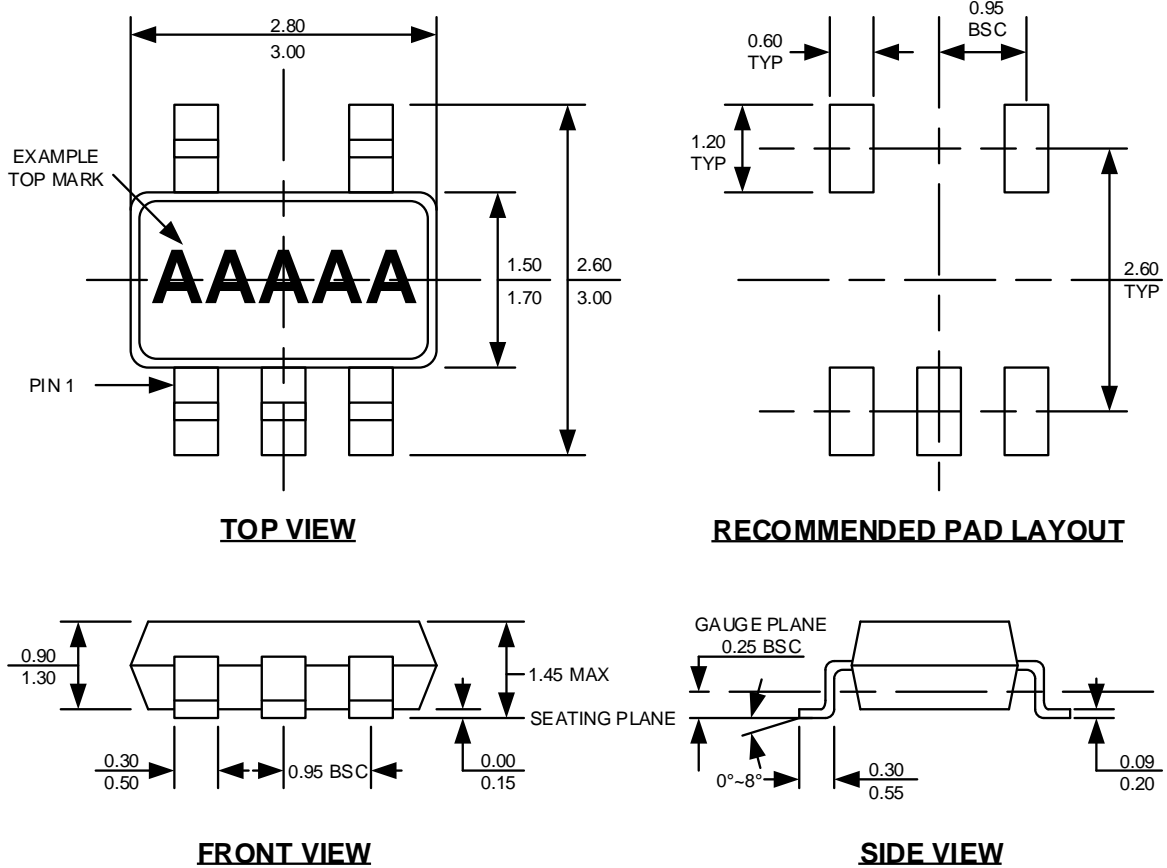

Note:

1. All dimensions are in millimeters.
2. Package length does not include mold flash, protrusion or gate burr.
3. Package width does not include flash or protrusion.
4. Lead coplanarity (bottom of leads after forming) shall be 0.10 millimeters max.
5. Pin 1 is lower left pin when reading top mark from left to right.