

General-purpose Operational Amplifiers / Comparators

NOW SERIES Comparators



LM393MX, LM2903MX, LM339MX, LM2901MX

No.11094ECT06

●Description

The Universal Standard family LM393 / LM339 / LM2903 / LM2901 monolithic ICs integrate two / four independent comparators on a single chip and feature high gain, low power consumption, and an operating voltage range from 2[V] to 36[V] (single power supply).

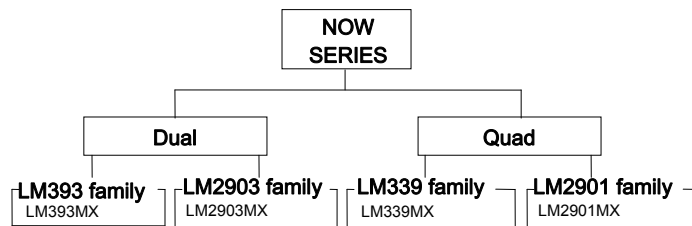

●Features

- 1) Operating temperature range Commercial Grade
LM339/393 family: 0[°C] to +70[°C]
Extended Industrial Grade
LM2903/2901 family: -40[°C] to +85[°C]
- 2) Open collector output
- 3) Single / dual power supply compatible
- 4) Low supply current
0.8[mA] typ.(LM2901/339 family)
0.4[mA] typ.(LM2903/393 family)
- 5) Low input-bias current: 25[nA] typ.
- 6) Low input-offset current: 5[nA] typ.
- 7) Input common-mode voltage range, including ground
- 8) Differential input voltage range equal to maximum rated supply voltage
- 9) Low output saturation voltage
- 10) TTL,MOS,CMOS compatible output

●Pin Assignment

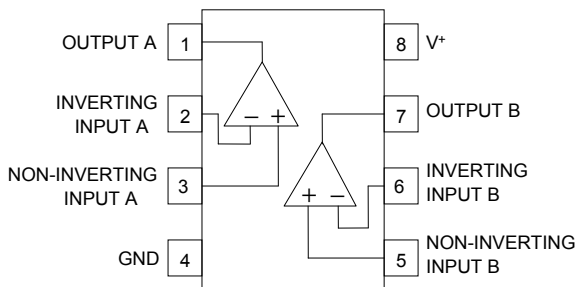

S.O package8

LM393MX
LM2903MX

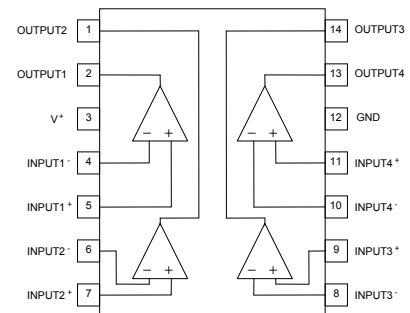

S.O package14

LM339MX
LM2901MX

● Absolute Maximum Ratings (Ta=25°C)

Parameter	Symbol	Rating				Unit
		LM393 family	LM339 family	LM2903 family	LM2901 family	
Supply Voltage	V ⁺ -GND	+36				V
Input Differential Voltage	V _{id}	±36				V
Common-mode Input Voltage	V _{icm}	-0.3 to +36				V
Operating Temperature Range	T _{opr}	0 to +70		-40 to +85		°C
Storage Temperature Range	T _{stg}	-65 to +150				°C
Maximum Junction Temperature	T _{jmax}	+150				°C

● Electric Characteristics

OLM393/339 Family (Unless otherwise specified, V⁺=+5[V])

Parameter	Symbol	Temperature range	Limits						Unit	Condition	Fig.No
			LM393 family			LM339 family					
			Min.	Typ.	Max.	Min.	Typ.	Max.			
Input Offset Voltage (*1)	V _{IO}	25°C	—	1	7	—	2	7	mV	V ⁺ =5 to 30[V], V _o =1.4[V], R _S =0[Ω] V _{CM} =0[V] to V ⁺ -1.5[V]	88
		Full range	—	—	9	—	—	15			
Input Bias Voltage (*1)	I _{IB}	25°C	—	25	250	—	25	250	nA	I _{IN} (+) or I _{IN} (-) V _{CM} =0[V]	88
		Full range	—	—	400	—	—	400			
Input Offset Current (*1)	I _{IO}	25°C	—	5	50	—	5	50	nA	I _{IN} (+)-I _{IN} (-), V _{CM} =0[V]	88
		Full range	—	—	150	—	—	150			
Input Common-mode Voltage Range	V _{ICR}	25°C	0	—	V ⁺ -1.5	—	—	V ⁺ -1.5	V	V ⁺ =30[V]	88
		Full range	0	—	V ⁺ -2.0	—	—	V ⁺ -2.0			
Supply Current	I _{CC}	25°C	—	0.4	1	—	0.8	2.0	mA	RL=∞, V ⁺ =5[V]	89
			—	1	2.5	—	1.0	2.5		RL=∞, V ⁺ =36[V]	
Large Signal Voltage Gain	AVD	25°C	25	200	—	25	100	—	V/mV	V ⁺ =15[V], V _o =1[V] to 11[V] RL ≥ 15[kΩ]	88
Large Signal Response Time	t _{REL}	25°C	—	300	—	—	300	—	ns	V _{IN} =TTL logic swing, V _{ref} =1.4[V] V _{RL} =5[V], R _L =5.1[kΩ]	89
Response Time	t _{RE}	25°C	1.5	—	—	—	1.3	—	μs	V _{RL} =5[V], R _L =5.1[kΩ] V _{IN} =100[mVp-p] overdrive=5[mV]	89
Output Sink Current	I _{SINK}	25°C	6	16	—	6	16	—	mA	V _{IN} (-)=1[V], V _{IN} (+)=0[V] V _o ≤ 1.5[V]	89
Output Saturation Voltage	V _{OL}	25°C	—	250	400	—	250	400	mV	V _{IN} (-)=1[V], V _{IN} (+)=0[V] I _{SINK} ≤ 4[mA]	89
		Full range	—	—	700	—	—	700			
Output Leakage Current	I _{OH}	25°C	—	0.1	—	—	0.1	—	nA	V _{IN} (-)=0[V], V _{IN} (+)=1[V], V _o =5[V]	89
		Full range	—	—	—	—	—	1.0	μA		
Differential Input Voltage	V _{ID}	Full range	—	—	36	—	—	36	V	ALL V _{IN} ≥ 0[V]	—

(*1) Absolute value

OLM2903/2901 family(Unless otherwise specified, $V^+=+5[V]$)

Parameter	Symbol	Temperature range	Limit						Unit	Condition	Fig.No.
			LM2903 family			LM2901 family					
			Min.	Typ.	Max.	Min.	Typ.	Max.			
Input Offset Voltage (*2)	VIO	25°C	—	2	7	—	2	7	mV	$V^+=30[V]$, $V_O=1.4[V]$, $R_S=0[\Omega]$ $V_{CM}=0[V]$ to $V^+-1.5[V]$	88
		Full range	—	9	15	—	9	15			
Input Bias Current (*2)	IIB	25°C	—	25	250	—	25	250	nA	IIN(+) or IIN(-) $V_{CM}=0[V]$	88
		Full range	—	200	500	—	200	500			
Input Offset Current (*2)	IIO	25°C	—	5	50	—	5	50	nA	IIN(+)-IIN(-), $V_{CM}=0[V]$	88
		Full range	—	50	200	—	50	200			
Input Common-mode Voltage Range	VICR	25°C	—	—	$V^+-1.5$	—	—	$V^+-1.5$	V	$V^+=30[V]$	88
		Full range	—	—	$V^+-2.0$	—	—	$V^+-2.0$			
Supply Current	ICC	25°C	—	0.4	1	—	0.8	2	mA	$R_L=\infty$, $V^+=5[V]$	89
			—	1	2.5	—	1	2.5			
Voltage Gain	AVD	25°C	25	100	—	25	100	—	V/mV	$V^+=15[V]$, $V_O=1[V]$ to 11[V], $R_L \geq 15[k\Omega]$	88
Large Signal Response Time	tREL	25°C	—	300	—	—	300	—	ns	$V_{IN}=\text{TTL logic swing}$, $V_{ref}=1.4[V]$ $V_{RL}=5[V]$, $R_L=5.1[k\Omega]$	89
Response Time	tRE	25°C	—	1.5	—	—	1.3	—	μs	$V_{RL}=5[V]$, $R_L=5.1[k\Omega]$ $V_{IN}=100[mVp-p]$, overdrive=5[mV]	89
Output Sink Current	ISINK	25°C	6	16	—	6	16	—	mA	$V_{IN(-)}=1[V]$, $V_{IN(+)}=0[V]$ $V_O \leq 1.5[V]$	89
Saturation Voltage	VOL	25°C	—	250	400	—	250	400	mV	$V_{IN(-)}=1[V]$, $V_{IN(+)}=0[V]$ $I_{SINK} \leq 4[mA]$	89
		Full range	—	400	700	—	—	700			
Output Leakage Current	Ileak	25°C	—	0.1	—	—	0.1	—	nA	$V_{IN(-)}=0[V]$, $V_{IN(+)}=1[V]$, $V_O=5[V]$	89
		Full range	—	—	1	—	—	1	μA	$V_{IN(-)}=0[V]$, $V_{IN(+)}=1[V]$, $V_O=30[V]$	
Differential Input Voltage	VID	Full range	—	—	36	—	—	36	V	ALL $V_{IN} \geq 0[V]$	—

(*2) Absolute value

●Reference Data LM393 family

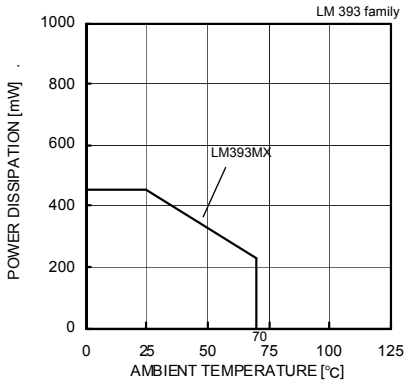

Fig. 1 Derating Curve

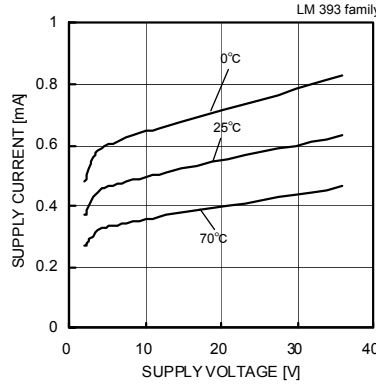

Fig. 2 Supply Current - Supply Voltage

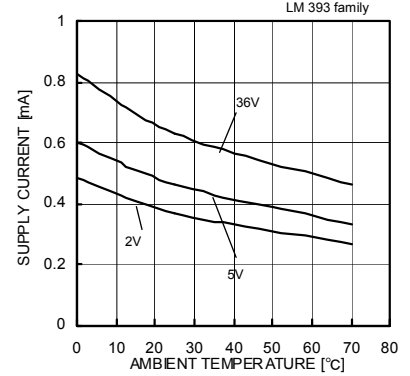

Fig. 3 Supply Current - Ambient Temperature

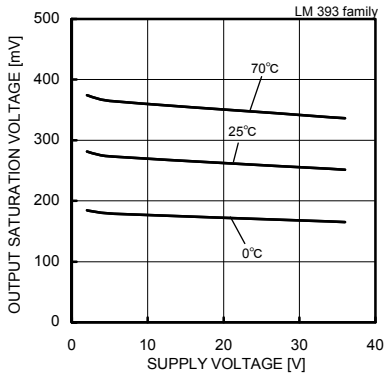

Fig. 4 Output Saturation Voltage - Supply Voltage (IOL=4[mA])

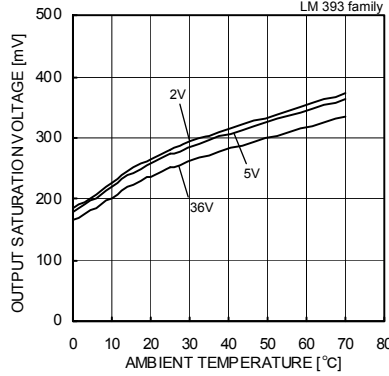

Fig. 5 Output Saturation Voltage - Ambient Temperature (IOL=4[mA])

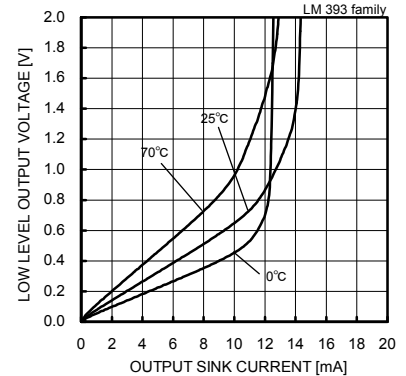

Fig. 6 Low Level Output Voltage - Output Sink Current (VCC=5[V])

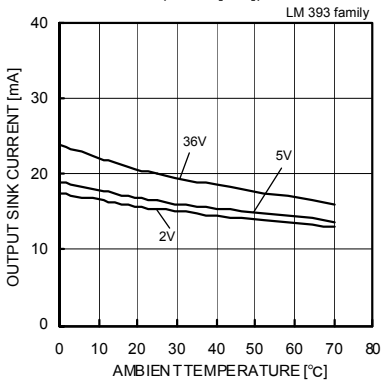

Fig. 7 Output Sink Current - Ambient Temperature (VOUT=1.5[V])

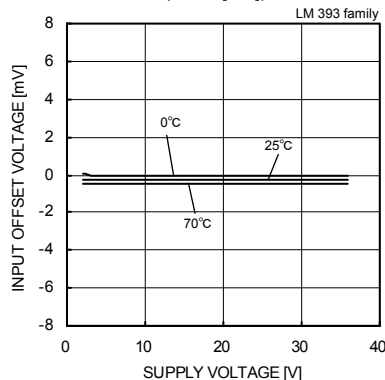

Fig. 8 Input Offset Voltage - Supply Voltage

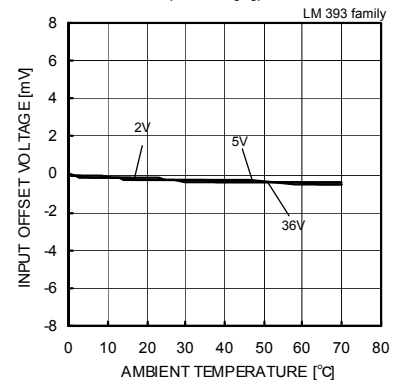

Fig. 9 Input Offset Voltage - Ambient Temperature

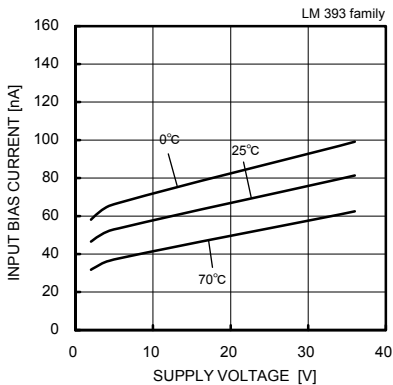

Fig. 10 Input Bias Current - Supply Voltage

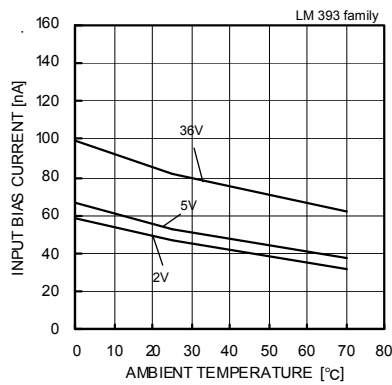

Fig. 11 Input Bias Current - Ambient Temperature

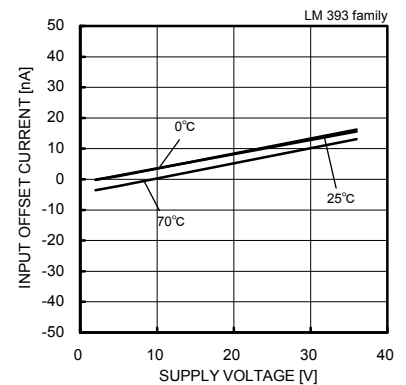

Fig. 12 Input Offset Current - Supply Voltage

(*The data above is ability value of sample, it is not guaranteed. LM393family: 0[°C]~+70[°C]

●Reference Data LM393 family

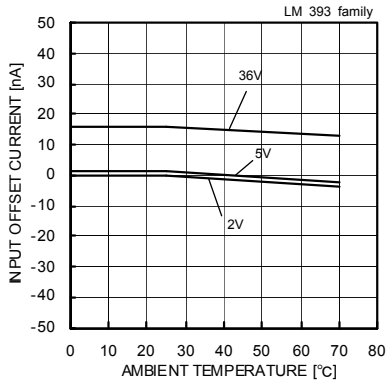

Fig. 13
Input Offset Current
– Ambient Temperature

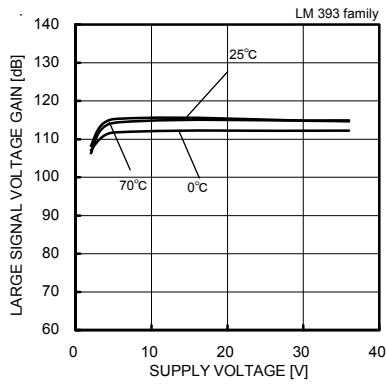

Fig. 14
Large Signal Voltage Gain
– Supply Voltage

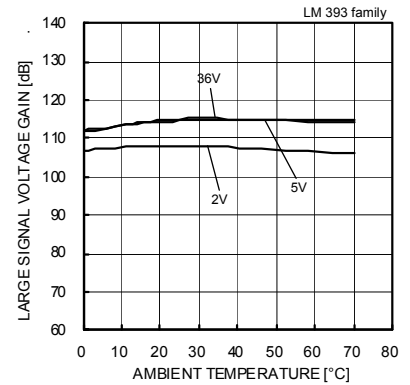

Fig. 15
Large Signal Voltage Gain
– Ambient Temperature

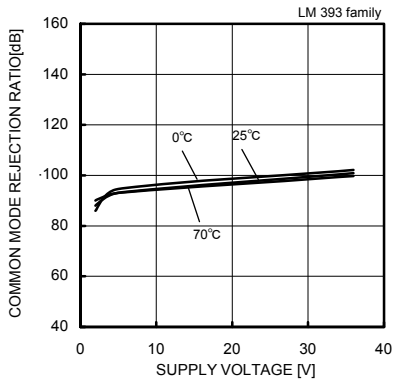

Fig. 16
Common Mode Rejection Ratio
– Supply Voltage

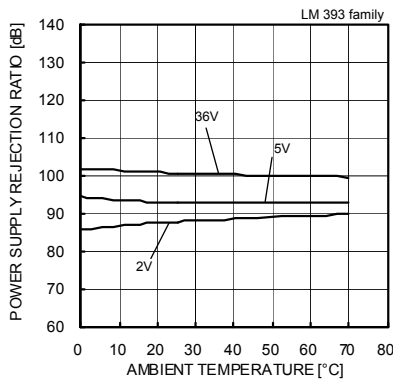

Fig. 17
Common Mode Rejection Ratio
– Ambient Temperature

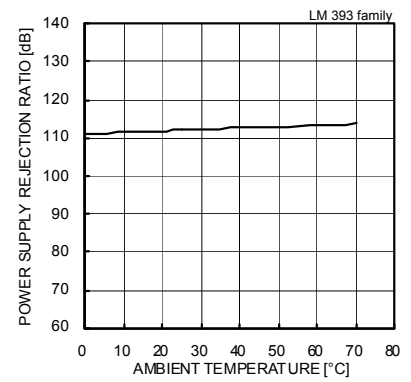

Fig. 18
Power Supply Rejection Ratio
– Ambient Temperature

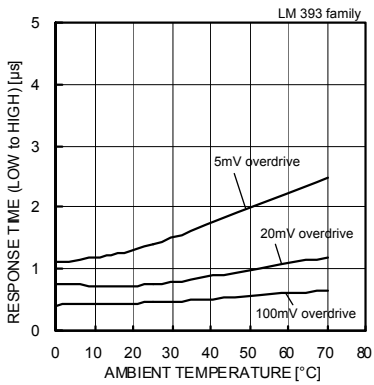

Fig. 19
Response Time (Low to High)
– Ambient Temperature
(VCC=5[V],VRL=5[V],RL=5.1[kΩ])

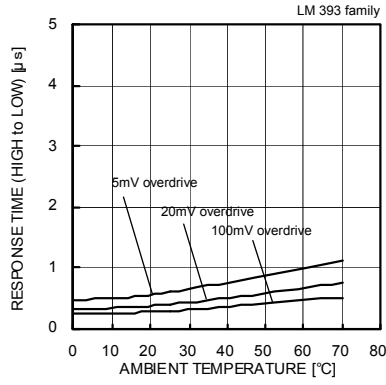

Fig. 20
Response Time (High to Low)
– Ambient Temperature
(VCC=5[V],VRL=5[V],RL=5.1[kΩ])

(*)The data above is ability value of sample, it is not guaranteed. LM393family:0[°C]~+70[°C]

●Reference Data LM339 family

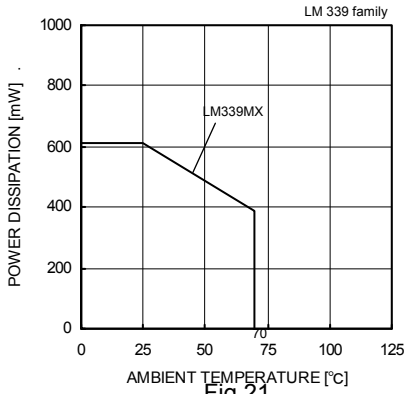

Fig. 21
Derating Curve

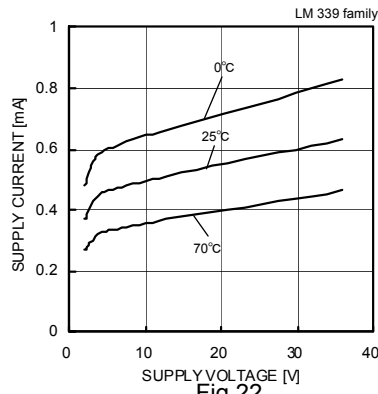

Fig. 22
Supply Current - Supply Voltage

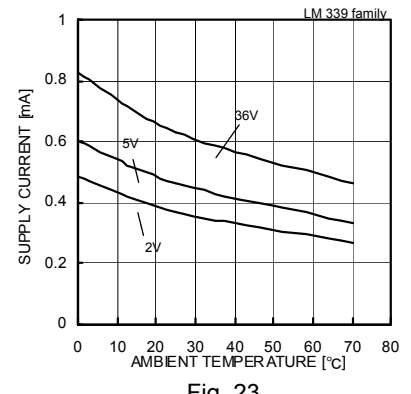

Fig. 23
Supply Current - Ambient Temperature

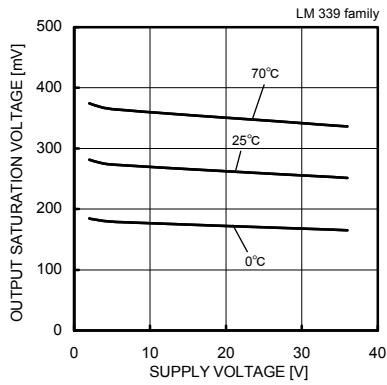

Fig. 24
Output Saturation Voltage
- Supply Voltage
(IOL=4[mA])

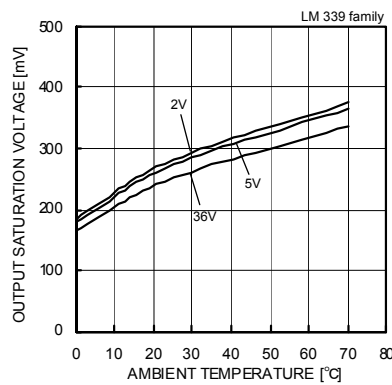

Fig. 25
Output Saturation Voltage
- Ambient Temperature
(IOL=4[mA])

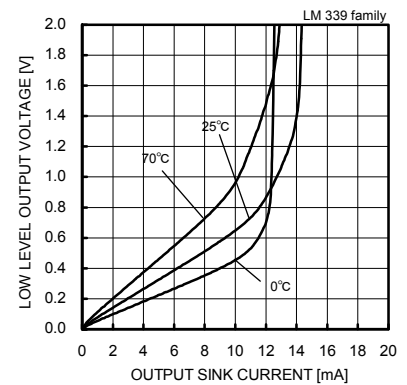

Fig. 26
Low Level Output Voltage
- Output Sink Current
(VCC=5[V])

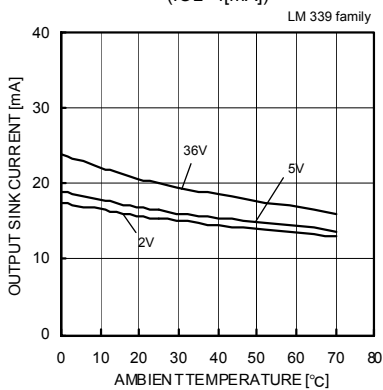

Fig. 27
Output Sink Current - Ambient Temperature
(VOUT=1.5[V])

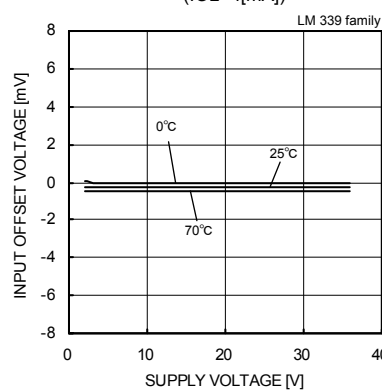

Fig. 28
Input Offset Voltage - Supply Voltage

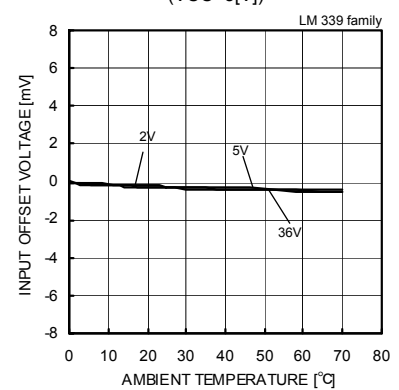

Fig. 29
Input Offset Voltage - Ambient Temperature

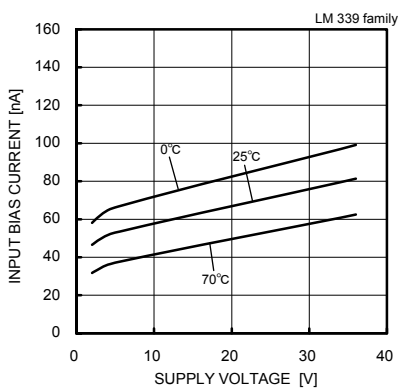

Fig. 30
Input Bias Current - Supply Voltage

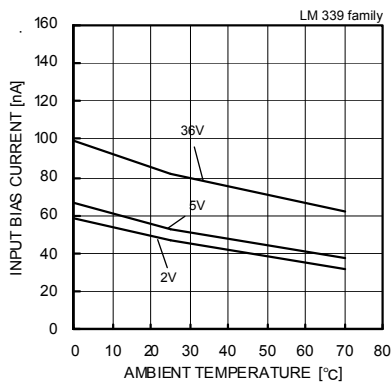

Fig. 31
Input Bias Current - Ambient Temperature

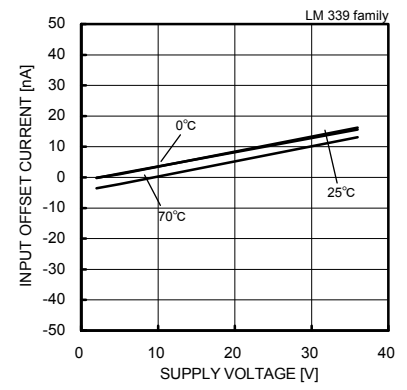

Fig. 32
Input Offset Current - Supply Voltage

(*)The data above is ability value of sample, it is not guaranteed. LM339family:0[°C]~+70[°C]

●Reference Data LM339 family

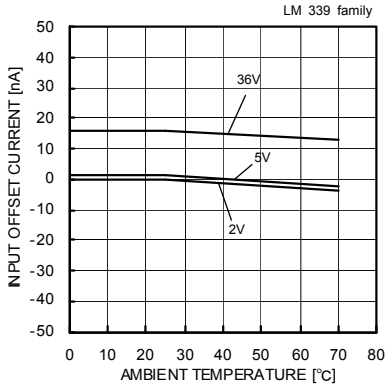

Fig. 33
Input Offset Current
– Ambient Temperature

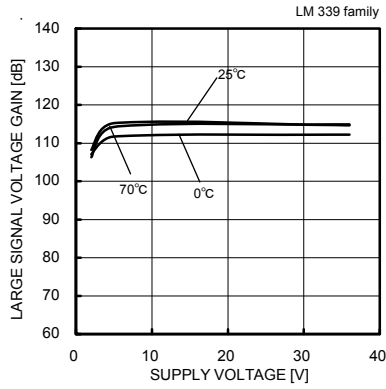

Fig. 34
Large Signal Voltage Gain
– Supply Voltage

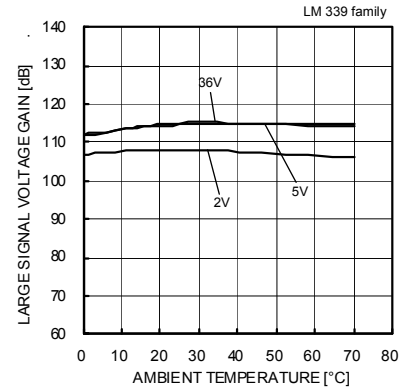

Fig. 35
Large Signal Voltage Gain
– Ambient Temperature

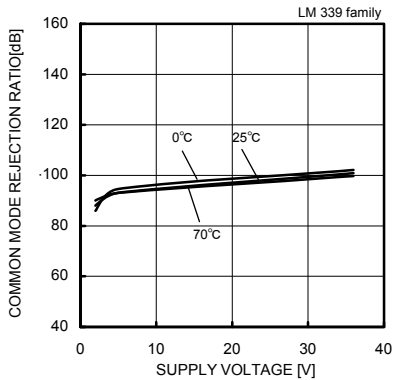

Fig. 36
Common Mode Rejection Ratio
– Supply Voltage

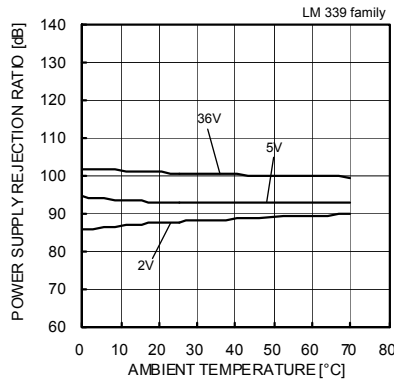

Fig. 37
Common Mode Rejection Ratio
– Ambient Temperature

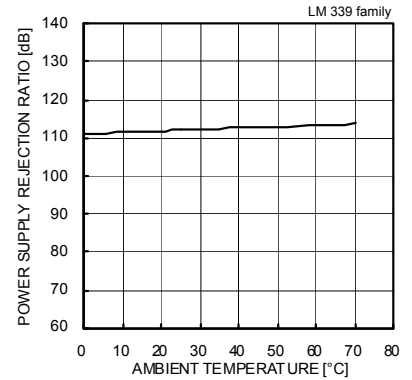

Fig. 38
Power Supply Rejection Ratio
– Ambient Temperature

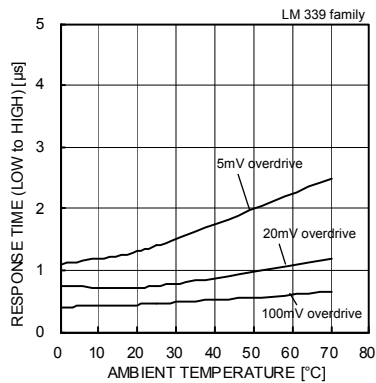

Fig. 39
Response Time (Low to High)
– Ambient Temperature
(VCC=5[V],VRL=5[V],RL=5.1[kΩ])

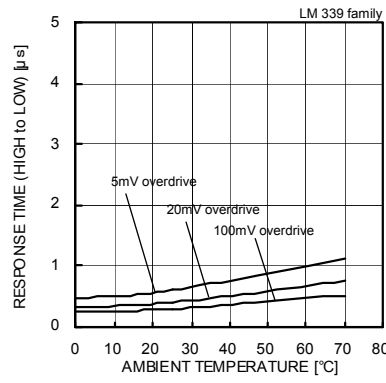

Fig. 40
Response Time (High to Low)
– Ambient Temperature
(VCC=5[V],VRL=5[V],RL=5.1[kΩ])

(*)The data above is ability value of sample, it is not guaranteed. LM339family:0[°C]~+70[°C]

●Reference Data LM2903 family

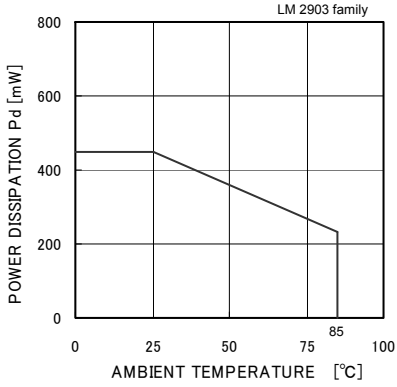

Fig. 41
Derating Curve

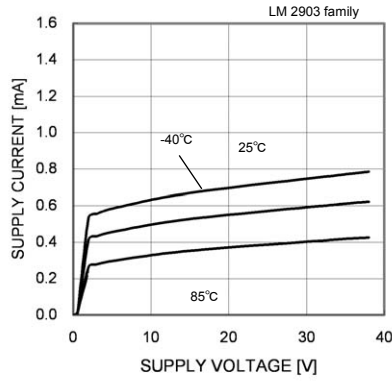

Fig. 42
Supply Current - Supply Voltage

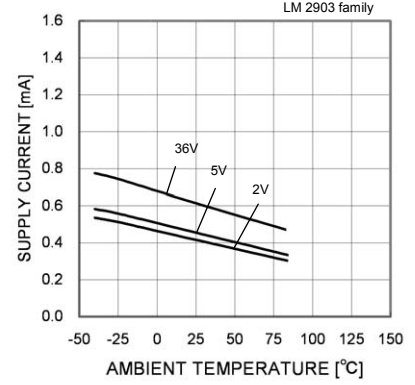

Fig. 43
Supply Current - Ambient Temperature

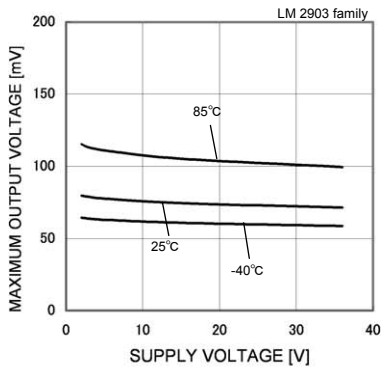

Fig. 44
Output Saturation Voltage
- Supply Voltage
(IOL=4[mA])

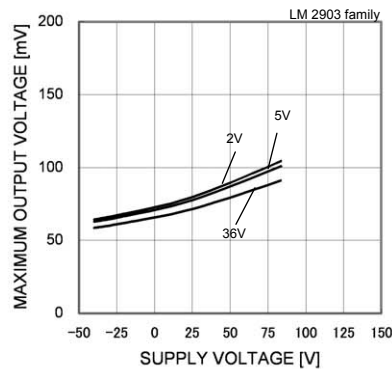

Fig. 45
Output Saturation Voltage
- Ambient Temperature
(IOL=4[mA])

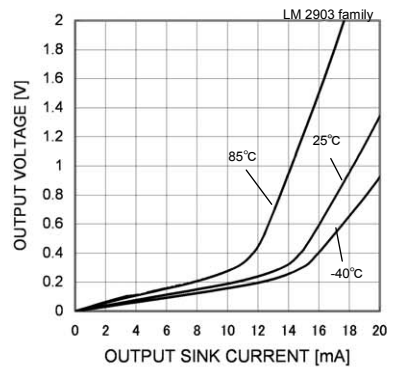

Fig. 46
Low Level Output Voltage
- Output Sink Current
(VCC=5[V])

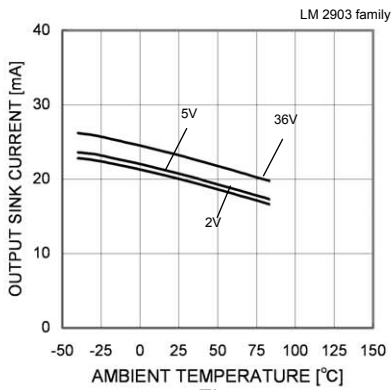

Fig. 47
Output Sink Current - Ambient
Temperature
(VOUT=1.5[V])

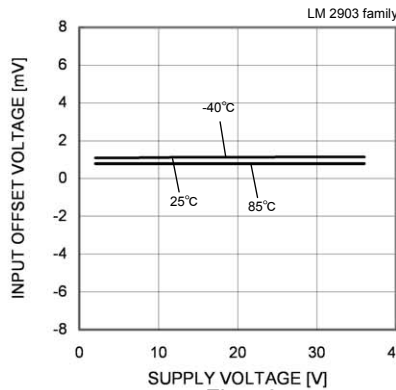

Fig. 48
Input Offset Voltage - Supply Voltage

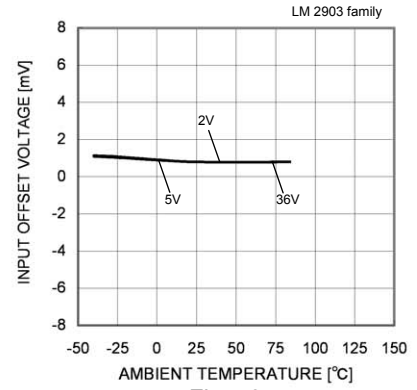

Fig. 49
Input Offset Voltage - Ambient Temperature

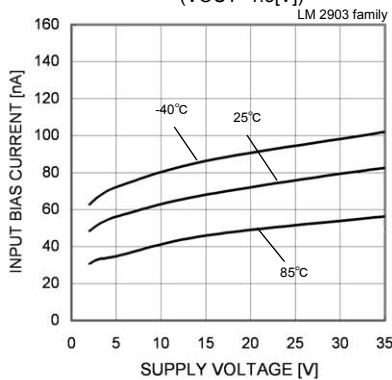

Fig. 50
Input Bias Current - Supply Voltage

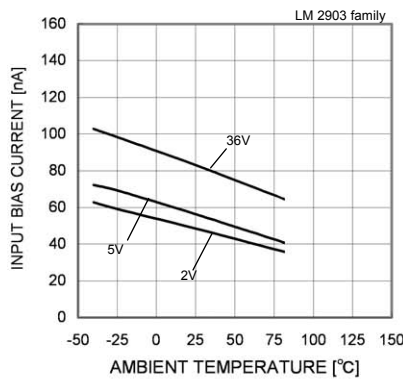

Fig. 51
Input Bias Current - Ambient Temperature

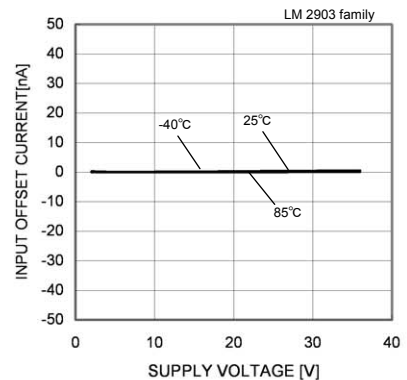

Fig. 52
Input Offset Current - Supply Voltage

(*)The data above is ability value of sample, it is not guaranteed.LM2903family:-40[°C]~+85[°C]

●Reference Data LM2903 family

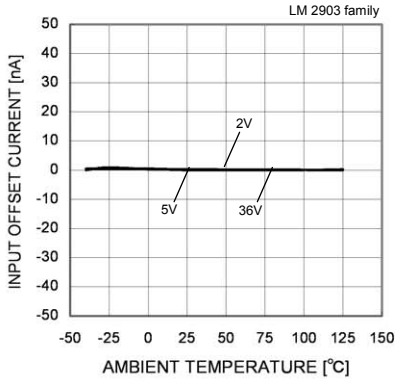

Fig. 53
Input Offset Current – Ambient Temperature

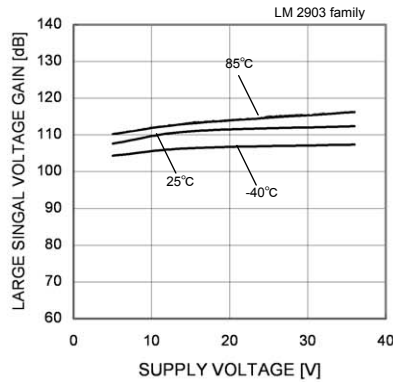

Fig. 54
Large Signal Voltage Gain – Supply Voltage

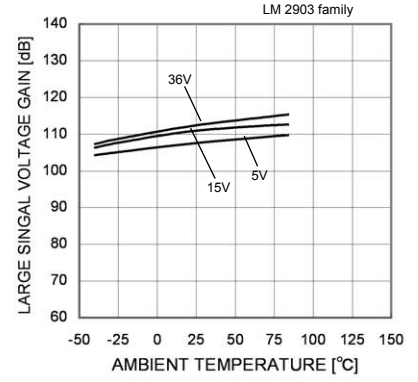

Fig. 55
Large Signal Voltage Gain – Ambient Temperature

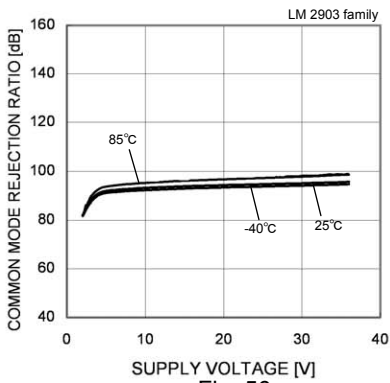

Fig. 56
Common Mode Rejection Ratio – Supply Voltage

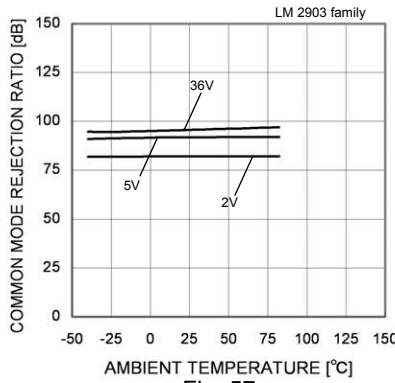

Fig. 57
Common Mode Rejection Ratio – Ambient Temperature

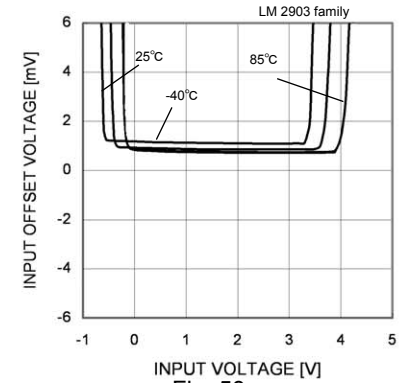

Fig. 58
Input Offset Voltage – Input Voltage (VCC=5V)

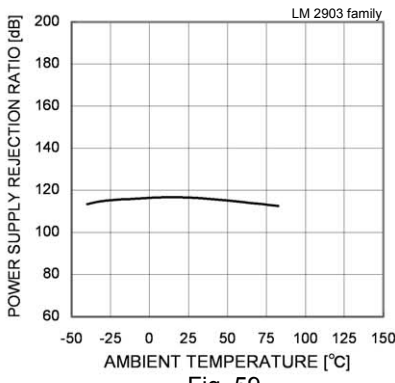

Fig. 59
Power Supply Rejection Ratio – Ambient Temperature

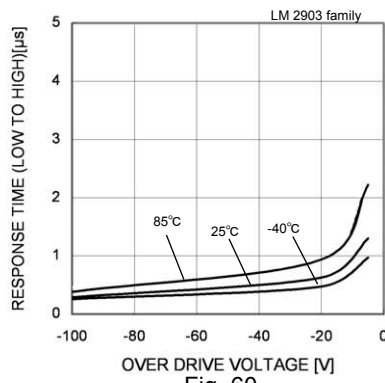

Fig. 60
Response Time (Low to High) – Over Drive Voltage (VCC=5[V],VRL=5[V],RL=5.1[kΩ])

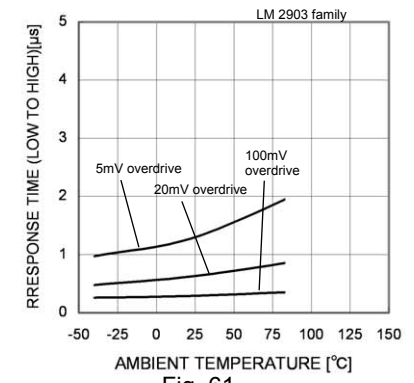

Fig. 61
Response Time (Low to High) – Ambient Temperature (VCC=5[V],VRL=5[V],RL=5.1[kΩ])

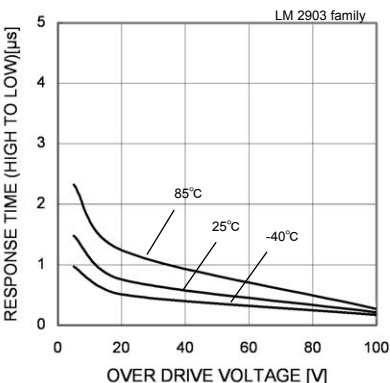

Fig. 62
Response Time (High to Low) – Over Drive Voltage

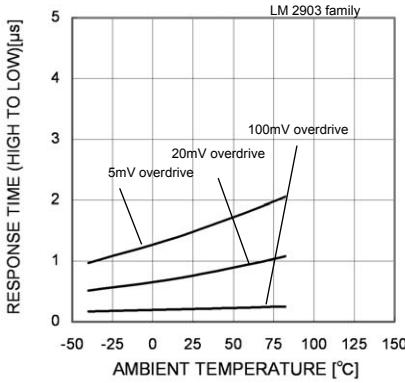

Fig. 63
Response Time (High to Low) – Ambient Temperature

(*)The data above is ability value of sample, it is not guaranteed. LM2903family:-40[°C]~+85[°C]

●Reference Data LM2901 family

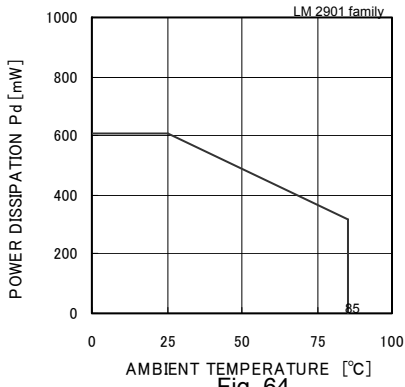

Fig. 64
Derating Curve

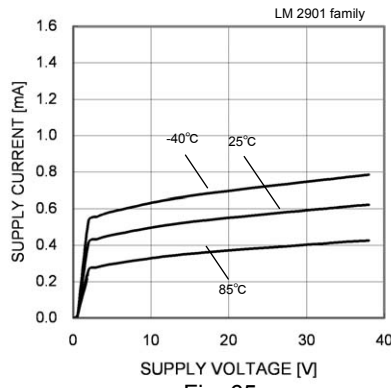

Fig. 65
Supply Current - Supply Voltage

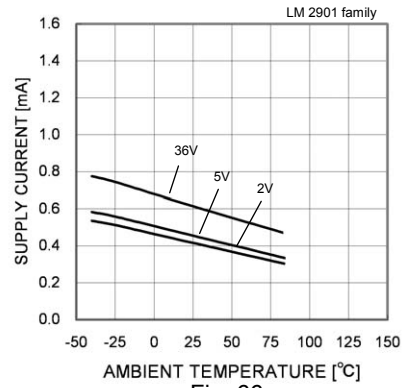

Fig. 66
Supply Current - Ambient Temperature

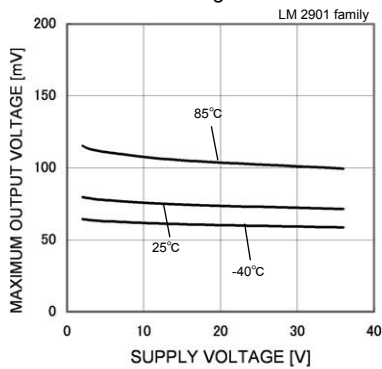

Fig. 67
Output Saturation Voltage
- Supply Voltage
(IOL=4[mA])

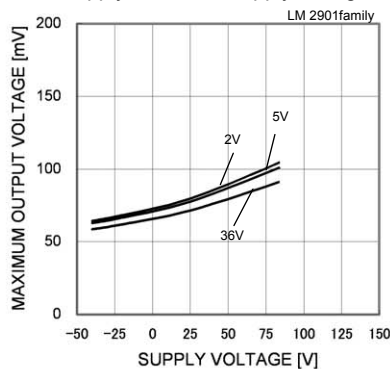

Fig. 68
Output Saturation Voltage
- Ambient Temperature
(IOL=4[mA])

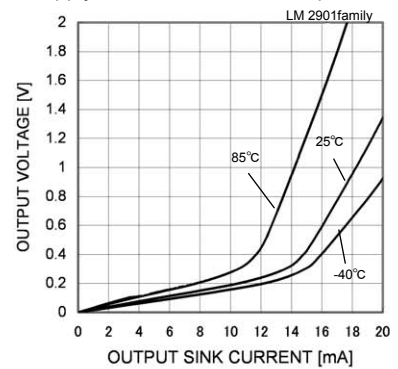

Fig. 69
Low Level Output Voltage
- Output Sink Current
(VCC=5[V])

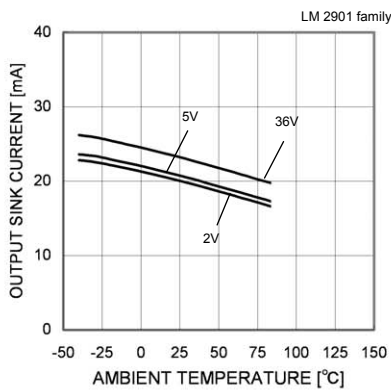

Fig. 70
Output Sink Current - Ambient
Temperature
(VOUT=1.5[V])

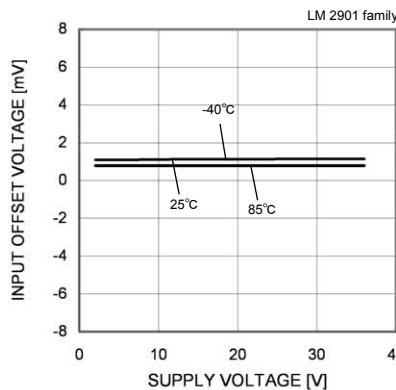

Fig. 71
Input Offset Voltage - Supply Voltage

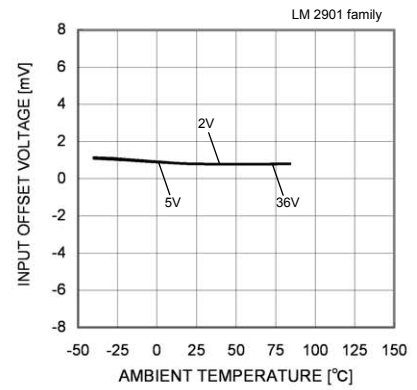

Fig. 72
Input Offset Voltage - Ambient Temperature

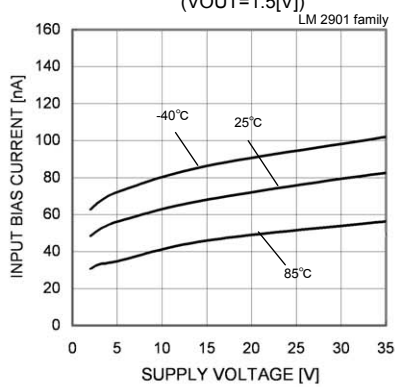

Fig. 73
Input Bias Current - Supply Voltage

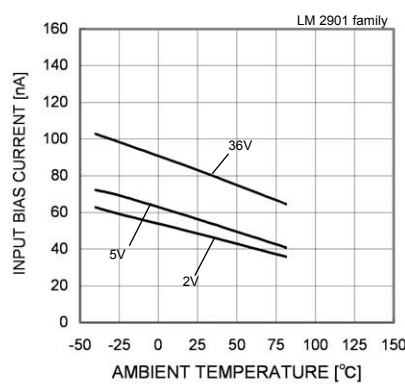

Fig. 74
Input Bias Current - Ambient Temperature

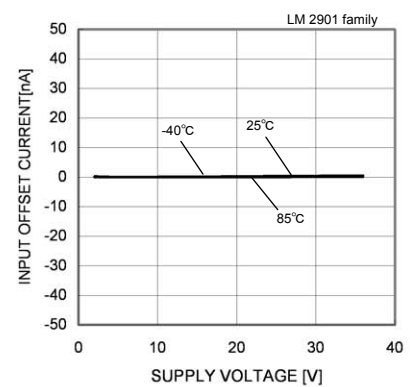

Fig. 75
Input Offset Current - Supply Voltage

(*)The data above is ability value of sample, it is not guaranteed.LM2903family:-40[°C]~+85[°C]

●Reference Data LM2901 family

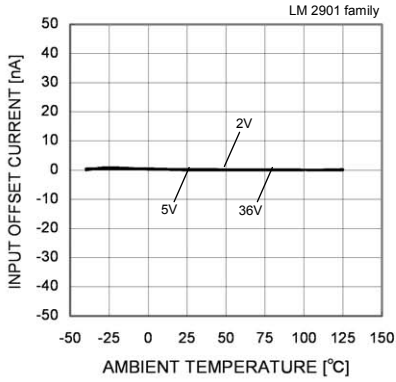

Fig. 76
Input Offset Current – Ambient Temperature

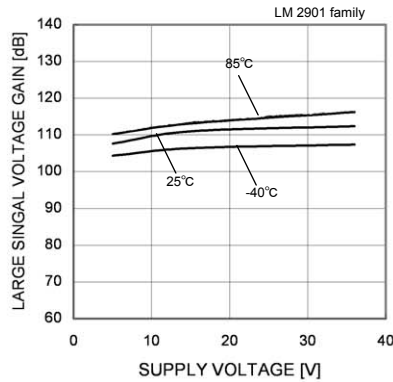

Fig. 77
Large Signal Voltage Gain – Supply Voltage

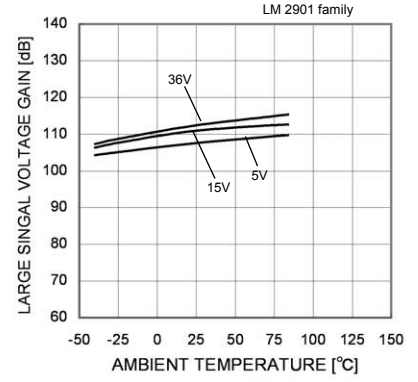

Fig. 78
Large Signal Voltage Gain – Ambient Temperature

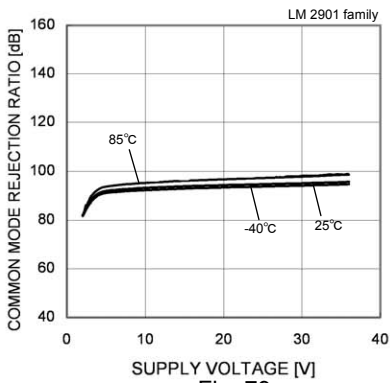

Fig. 79
Common Mode Rejection Ratio – Supply Voltage

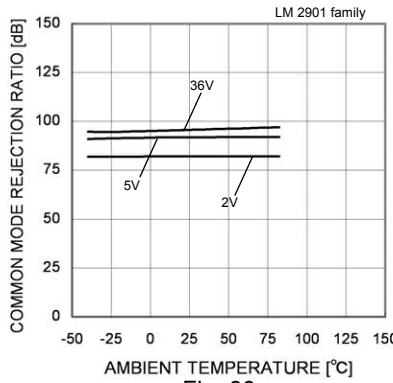

Fig. 80
Common Mode Rejection Ratio – Ambient Temperature

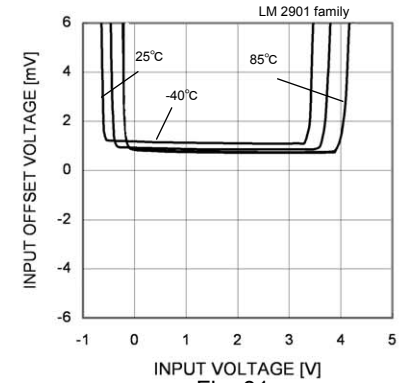

Fig. 81
Input Offset Voltage – Input Voltage (VCC=5V)

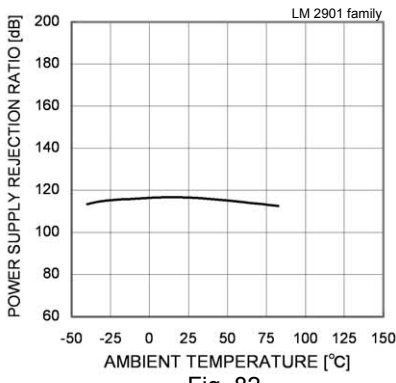

Fig. 82
Power Supply Rejection Ratio – Ambient Temperature

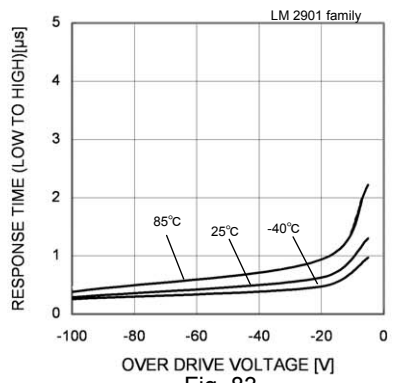

Fig. 83
Response Time (Low to High) – Over Drive Voltage (VCC=5[V],VRL=5[V],RL=5.1[kΩ])

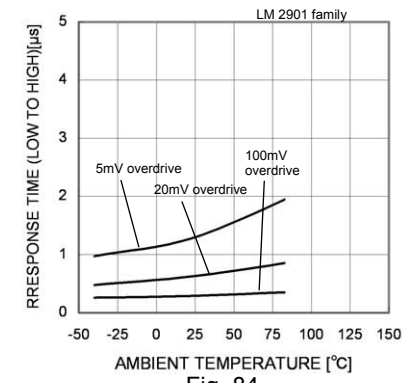

Fig. 84
Response Time (Low to High) – Ambient Temperature (VCC=5[V],VRL=5[V],RL=5.1[kΩ])

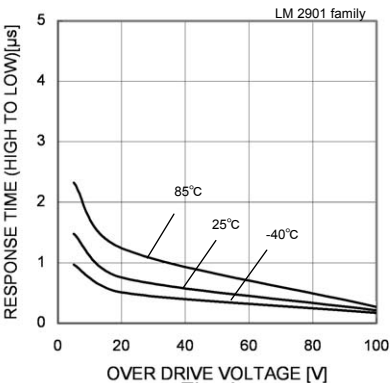

Fig. 85
Response Time (High to Low) – Over Drive Voltage

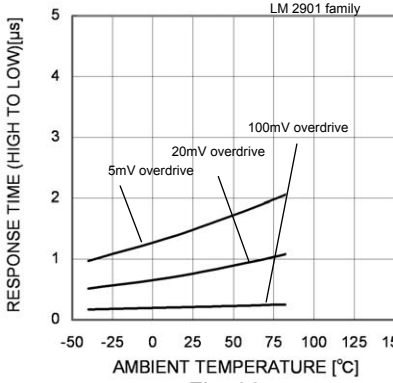

Fig. 86
Response Time (High to Low) – Ambient Temperature

(*)The data above is ability value of sample, it is not guaranteed. LM2903family:-40[°C]~+85[°C]

●Circuit Diagram

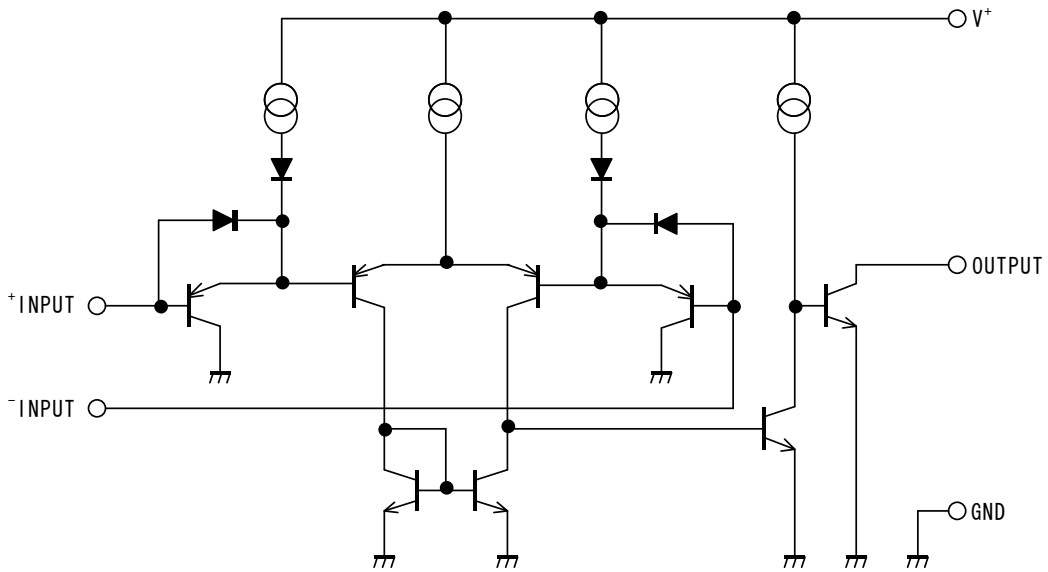

Fig.87 Circuit Diagram (each Comparator)

●Measurement circuit 1 NULL Method measurement condition

V+,GND,EK,VICR unit : [V]

Parameter	VF	S1	S2	S3	LM393/LM339 family				LM2903/LM2901 family				Calculation
					V ⁺	GND	EK	VICR	V ⁺	GND	EK	VICR	
Input Offset Voltage	VF1	ON	ON	ON	5 to 30	0	-1.4	0	5 to 30	0	-1.4	0	1
Input Offset Current	VF2	OFF	OFF	ON	5	0	-1.4	0	5	0	-1.4	0	2
Input Bias Current	VF3	OFF	ON	ON	5	0	-1.4	0	5	0	-1.4	0	3
	VF4	ON	OFF		5	0	-1.4	0	5	0	-1.4	0	
Voltage Gain	VF5	ON	ON	ON	15	0	-1.4	0	15	0	-1.4	0	4
	VF6				15	0	-11.4	0	15	0	-11.4	0	

— Calculation —

1.Input offset voltage (VIO)

$$V_{io} = \frac{|VF1|}{1 + R_f/R_s} \text{ [V]}$$

2.Input offset current (IIO)

$$I_{io} = \frac{|VF2 - VF1|}{R_i(1 + R_f/R_s)} \text{ [A]}$$

3.Input bias current (IIB)

$$I_b = \frac{|VF4 - VF3|}{2 \times R_i(1 + R_f/R_s)} \text{ [A]}$$

4.Voltage gain (AVD)

$$AV = 20 \times \text{Log} \frac{10 \times (1 + R_f/R_s)}{|VF6 - VF5|} \text{ [dB]}$$

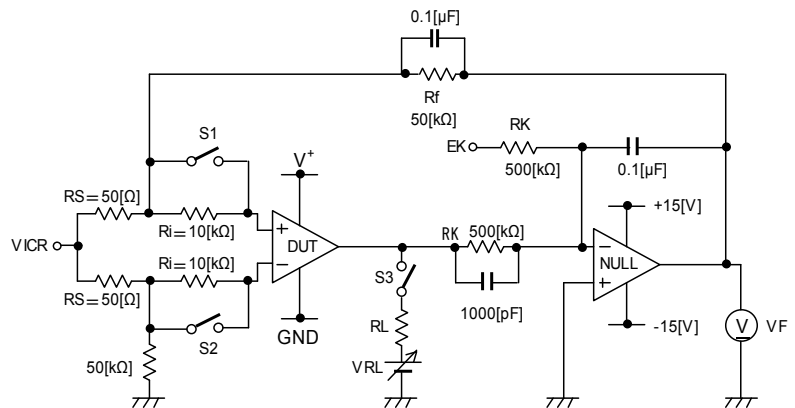

Fig.88 Measurement Circuit1 (each Comparator)

●Measurement Circuit 2: Switch Condition

SW No.		SW 1	SW 2	SW 3	SW 4	SW 5	SW 6	SW 7
Supply Current	—	OFF	OFF	OFF	OFF	OFF	OFF	OFF
Output Sink Current	VOL=1.5[V]	OFF	ON	ON	OFF	ON	ON	OFF
Saturation Voltage	IOL=4[mA]	OFF	ON	ON	OFF	OFF	OFF	ON
Output Leakage Current	VOH=36[V]	OFF	ON	ON	OFF	OFF	OFF	ON
Response Time	RL=5.1[kΩ]	ON	OFF	ON	ON	OFF	ON	OFF
	VRL=5[V]							

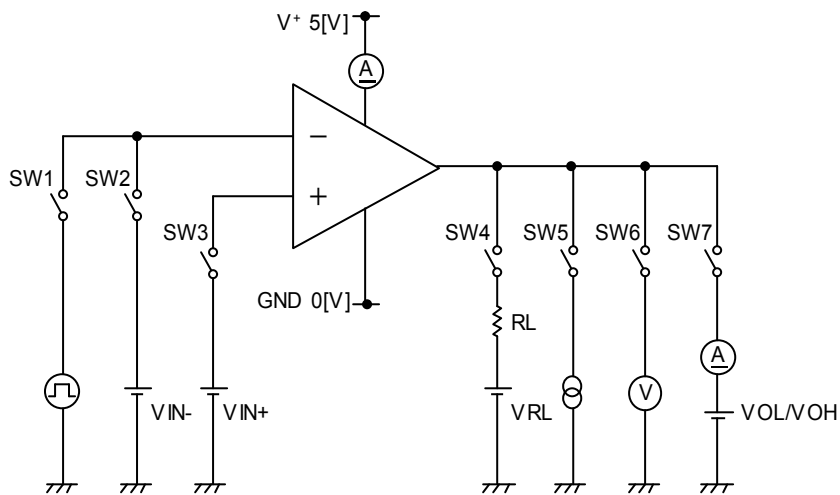

Fig.89 Measurement Circuit 2 (each Comparator)

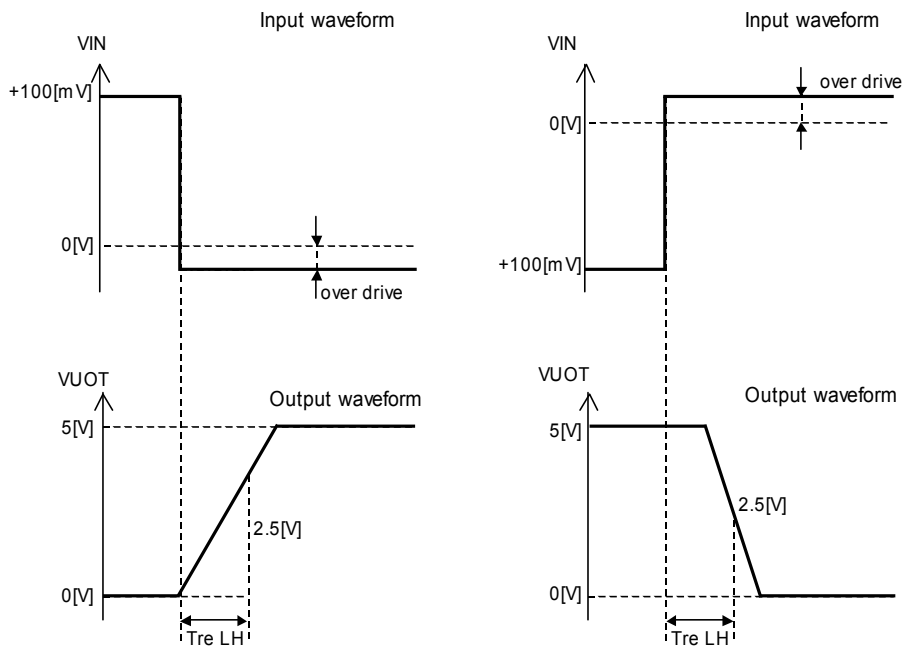

Fig.90 Response Time

●Description of electrical characteristics

Described below are descriptions of the relevant electrical terms.

Please note that item names, symbols, and their meanings may differ from those on another manufacturer's documents.

1. Absolute maximum ratings

The absolute maximum ratings are values that should never be exceeded, since doing so may result in deterioration of electrical characteristics or damage to the part itself as well as peripheral components.

1.1 Power supply voltage (V^+ /GND)

Expresses the maximum voltage that can be supplied between the positive and negative power supply terminals without causing deterioration of the electrical characteristics or destruction of the internal circuitry.

1.2 Differential input voltage (VID)

Indicates the maximum voltage that can be supplied between the non-inverting and inverting terminals without damaging the IC.

1.3 Input common-mode voltage range (VICR)

Signifies the maximum voltage that can be supplied to non-inverting and inverting terminals without causing deterioration of the electrical characteristics or damage to the IC itself. Normal operation is not guaranteed within the input common-mode voltage range of the maximum ratings – use within the input common-mode voltage range of the electric characteristics instead.

1.4 Operating temperature range and storage temperature range (Topr, Tstg)

The operating temperature range indicates the temperature range within which the IC can operate. The higher the ambient temperature, the lower the power consumption of the IC. The storage temperature range denotes the range of temperatures the IC can be stored under without causing excessive deterioration of the electrical characteristics.

1.5 Power dissipation (Pd)

Indicates the power that can be consumed by a particular mounted board at ambient temperature (25°C). For packaged products, Pd is determined by maximum junction temperature and the thermal resistance.

2. Electrical characteristics

2.1 Input offset voltage (VIO)

Signifies the voltage difference between the non-inverting and inverting terminals. It can be thought of as the input voltage difference required for setting the output voltage to 0V.

2.2 Input offset current (IIO)

Indicates the difference of the input bias current between the non-inverting and inverting terminals.

2.3 Input bias current (IIB)

Denotes the current that flows into or out of the input terminal, it is defined by the average of the input bias current at the non-inverting terminal and the input bias current at the inverting terminal.

2.4 Input common-mode voltage range (VICR)

Indicates the input voltage range under which the IC operates normally.

2.5 Large signal voltage gain (AVD)

The amplifying rate (gain) of the output voltage against the voltage difference between the non-inverting and inverting terminals, it is (normally) the amplifying rate (gain) with respect to DC voltage.

$AVD = (\text{output voltage fluctuation}) / (\text{input offset fluctuation})$

2.6 Circuit current (ICC)

Indicates the current of the IC itself that flows under specific conditions and during no-load steady state.

2.7 Output sink current (IOL)

Denotes the maximum current that can be output under specific output conditions.

2.8 Output saturation voltage low level output voltage (VOL)

Signifies the voltage range that can be output under specific output conditions.

2.9 Output leakage current (ILeak)

Indicates the current that flows into the IC under specific input and output conditions.

2.10 Response time (tre)

The interval between the application of input and output conditions.

2.11 Common-mode rejection ratio (CMRR)

Denotes the ratio of fluctuation of the input offset voltage when the in-phase input voltage is changed (DC fluctuation).

$CMRR = (\text{change of input common-mode voltage}) / (\text{input offset fluctuation})$

2.12 Power supply rejection ratio (PSRR)

Signifies the ratio of fluctuation of the input offset voltage when the supply voltage is changed (DC fluctuation).

$PSRR = (\text{change in power supply voltage}) / (\text{input offset fluctuation})$

●Derating Curves

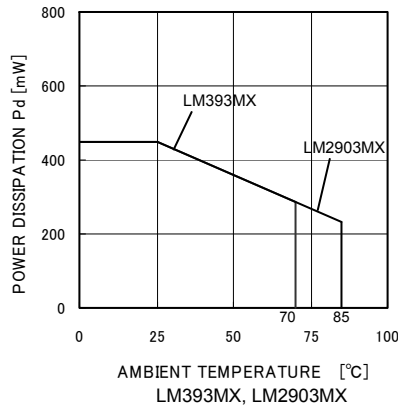

Power Dissipation

Package	Pd[W]	θ_{ja} [°C/W]
SO package8 (*8)	450	3.6

$\theta_{ja} = (T_j - T_a) / P_d [°C/W]$

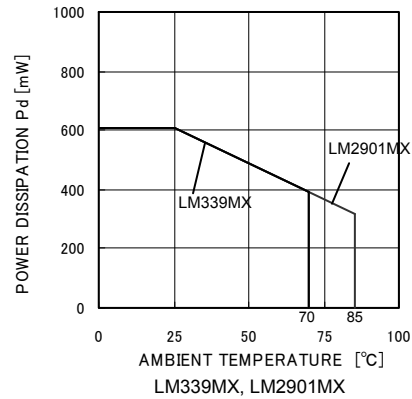

Power Dissipation

Package	Pd[W]	θ_{ja} [°C/W]
SO package14	610	4.9

$\theta_{ja} = (T_j - T_a) / P_d [°C/W]$

Fig.102 Derating Curves

●Notes for use

- 1) Unused circuits
When there are unused circuits it is recommended that they be connected as in Fig. 103, setting the non-inverting input terminal to a potential within the in-phase input voltage range (VICR).
- 2) Input terminal voltage
Applying GND + 36V to the input terminal is possible without causing deterioration of the electrical characteristics or destruction, irrespective of the supply voltage. However, this does not ensure normal circuit operation. Please note that the circuit operates normally only when the input voltage is within the common mode input voltage range of the electric characteristics.
- 3) Power supply (single / dual)
The op-amp operates when the specified voltage supplied is between V⁺ and GND. Therefore, the single supply op-amp can be used as a dual supply op-amp as well.
- 4) Power dissipation Pd
Using the unit in excess of the rated power dissipation may cause deterioration in electrical characteristics due to a rise in chip temperature, including reduced current capability. Therefore, please take into consideration the power dissipation (Pd) under actual operating conditions and apply a sufficient margin in thermal design. Refer to the thermal derating curves for more information.
- 5) Short-circuit between pins and erroneous mounting
Incorrect mounting may damage the IC. In addition, the presence of foreign particles between the outputs, the output and the power supply, or the output and GND may result in IC destruction.
- 6) Terminal short-circuits
When the output and V⁺ terminals are shorted, excessive output current may flow, resulting in undue heat generation and, subsequently, destruction.
- 7) Operation in a strong electromagnetic field
Operation in a strong electromagnetic field may cause malfunctions.
- 8) Radiation
This IC is not designed to withstand radiation.
- 9) IC handling
Applying mechanical stress to the IC by deflecting or bending the board may cause fluctuations in the electrical characteristics due to piezoelectric (piezo) effects.
- 10) Board inspection
Connecting a capacitor to a pin with low impedance may stress the IC. Therefore, discharging the capacitor after every process is recommended. In addition, when attaching and detaching the jig during the inspection phase, ensure that the power is turned OFF before inspection and removal. Furthermore, please take measures against ESD in the assembly process as well as during transportation and storage.

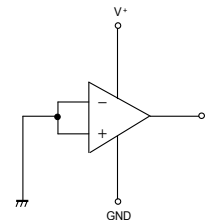

Fig.103

●Ordering part number

L	M	3	3	9
---	---	---	---	---

Family name
LM393
LM339
LM2901
LM2903

M

Package
M : S.O package

X

Packaging and forming specification
X: Embossed tape and reel

S.O package8

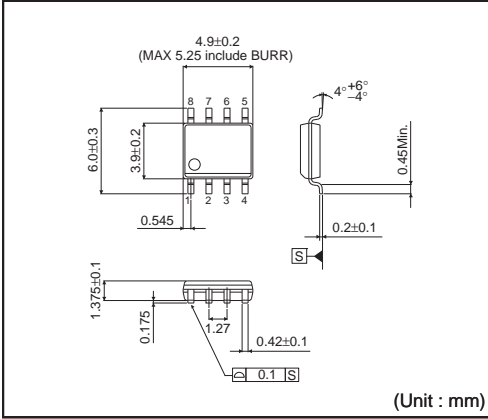

<Tape and Reel information>

Tape	Embossed carrier tape
Quantity	2500pcs
Direction of feed	(The direction is the 1pin of product is at the upper left when you hold reel on the left hand and you pull out the tape on the right hand)

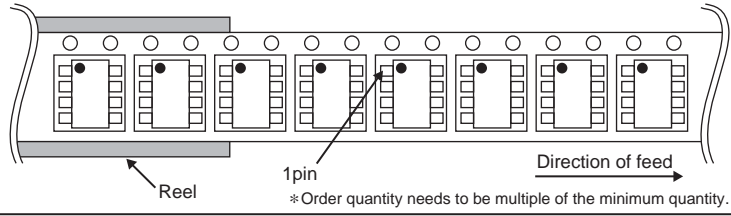

S.O package14

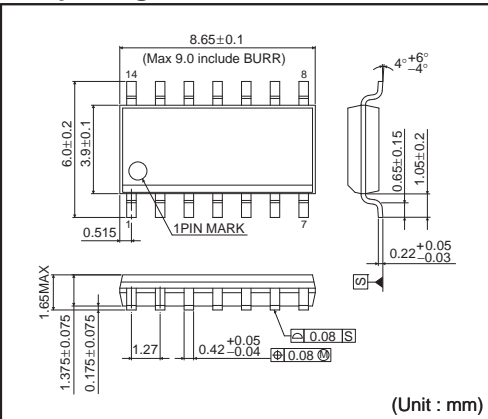

<Tape and Reel information>

Tape	Embossed carrier tape
Quantity	2500pcs
Direction of feed	(The direction is the 1pin of product is at the upper left when you hold reel on the left hand and you pull out the tape on the right hand)

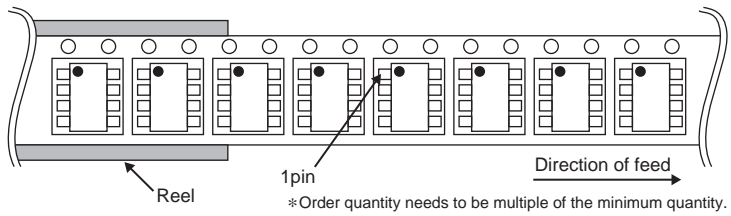

Notes

No copying or reproduction of this document, in part or in whole, is permitted without the consent of ROHM Co.,Ltd.

The content specified herein is subject to change for improvement without notice.

The content specified herein is for the purpose of introducing ROHM's products (hereinafter "Products"). If you wish to use any such Product, please be sure to refer to the specifications, which can be obtained from ROHM upon request.

Examples of application circuits, circuit constants and any other information contained herein illustrate the standard usage and operations of the Products. The peripheral conditions must be taken into account when designing circuits for mass production.

Great care was taken in ensuring the accuracy of the information specified in this document. However, should you incur any damage arising from any inaccuracy or misprint of such information, ROHM shall bear no responsibility for such damage.

The technical information specified herein is intended only to show the typical functions of and examples of application circuits for the Products. ROHM does not grant you, explicitly or implicitly, any license to use or exercise intellectual property or other rights held by ROHM and other parties. ROHM shall bear no responsibility whatsoever for any dispute arising from the use of such technical information.

The Products specified in this document are intended to be used with general-use electronic equipment or devices (such as audio visual equipment, office-automation equipment, communication devices, electronic appliances and amusement devices).

The Products specified in this document are not designed to be radiation tolerant.

While ROHM always makes efforts to enhance the quality and reliability of its Products, a Product may fail or malfunction for a variety of reasons.

Please be sure to implement in your equipment using the Products safety measures to guard against the possibility of physical injury, fire or any other damage caused in the event of the failure of any Product, such as derating, redundancy, fire control and fail-safe designs. ROHM shall bear no responsibility whatsoever for your use of any Product outside of the prescribed scope or not in accordance with the instruction manual.

The Products are not designed or manufactured to be used with any equipment, device or system which requires an extremely high level of reliability the failure or malfunction of which may result in a direct threat to human life or create a risk of human injury (such as a medical instrument, transportation equipment, aerospace machinery, nuclear-reactor controller, fuel-controller or other safety device). ROHM shall bear no responsibility in any way for use of any of the Products for the above special purposes. If a Product is intended to be used for any such special purpose, please contact a ROHM sales representative before purchasing.

If you intend to export or ship overseas any Product or technology specified herein that may be controlled under the Foreign Exchange and the Foreign Trade Law, you will be required to obtain a license or permit under the Law.



Thank you for your accessing to ROHM product informations.
More detail product informations and catalogs are available, please contact us.

ROHM Customer Support System

<http://www.rohm.com/contact/>