

General Description

These P-Channel enhancement mode power field effect transistors are using trench DMOS technology. This advanced technology has been especially tailored to minimize on-state resistance, provide superior switching performance, and withstand high energy pulse in the avalanche and commutation mode. These devices are well suited for high efficiency fast switching applications.

SOT23-3S Pin Configuration

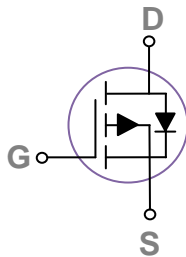
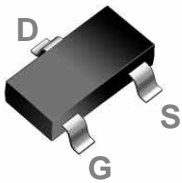

BVDSS	RDSON	ID
-20V	65mΩ	-4.1A

Features

- -20V, -4.1A, $R_{DS(ON)} = 65m\Omega @ V_{GS} = -4.5V$
- Improved dv/dt capability
- Fast switching
- Green Device Available
- Suit for -1.8V Gate Drive Applications

Applications

- Notebook
- Load Switch
- Hand-Held Instruments

Absolute Maximum Ratings $T_c=25^\circ\text{C}$ unless otherwise noted

Symbol	Parameter	Rating	Units
V_{DS}	Drain-Source Voltage	-20	V
V_{GS}	Gate-Source Voltage	± 10	V
I_D	Drain Current – Continuous ($T_c=25^\circ\text{C}$)	-4.1	A
	Drain Current – Continuous ($T_c=100^\circ\text{C}$)	-2.6	A
I_{DM}	Drain Current – Pulsed ¹	-16.4	A
P_D	Power Dissipation ($T_c=25^\circ\text{C}$)	1.56	W
	Power Dissipation – Derate above 25°C	0.012	W/ $^\circ\text{C}$
T_{STG}	Storage Temperature Range	-55 to 150	$^\circ\text{C}$
T_J	Operating Junction Temperature Range	-55 to 150	$^\circ\text{C}$

Thermal Characteristics

Symbol	Parameter	Typ.	Max.	Unit
$R_{\theta JA}$	Thermal Resistance Junction to ambient	---	80	$^\circ\text{C/W}$

Electrical Characteristics ($T_J=25\text{ }^\circ\text{C}$, unless otherwise noted)
Off Characteristics

Symbol	Parameter	Conditions	Min.	Typ.	Max.	Unit
BV_{DSS}	Drain-Source Breakdown Voltage	$V_{GS}=0V, I_D=-250\mu A$	-20	---	---	V
$\Delta BV_{DSS}/\Delta T_J$	BV_{DSS} Temperature Coefficient	Reference to 25°C , $I_D=-1\text{mA}$	---	-0.02	---	$V/^\circ\text{C}$
I_{DSS}	Drain-Source Leakage Current	$V_{DS}=-20V, V_{GS}=0V, T_J=25^\circ\text{C}$	---	---	-1	μA
		$V_{DS}=-16V, V_{GS}=0V, T_J=125^\circ\text{C}$	---	---	-10	μA
I_{GSS}	Gate-Source Leakage Current	$V_{GS}=\pm 10V, V_{DS}=0V$	---	---	± 100	nA

On Characteristics

$R_{DS(ON)}$	Static Drain-Source On-Resistance	$V_{GS}=-4.5V, I_D=-3A$	---	52	65	m Ω
		$V_{GS}=-2.5V, I_D=-2A$	---	73	85	
		$V_{GS}=-1.8V, I_D=-1.5A$	---	105	130	
$V_{GS(th)}$	Gate Threshold Voltage	$V_{GS}=V_{DS}, I_D=-250\mu A$	-0.4	-0.6	-0.8	V
$\Delta V_{GS(th)}$	$V_{GS(th)}$ Temperature Coefficient		---	2	---	$\text{mV}/^\circ\text{C}$
gfs	Forward Transconductance	$V_{DS}=-10V, I_S=-3A$	---	5.5	---	S

Dynamic and switching Characteristics

Q_g	Total Gate Charge ^{2,3}	$V_{DS}=-10V, V_{GS}=-4.5V, I_D=-3A$	---	6.4	9	nC
Q_{gs}	Gate-Source Charge ^{2,3}		---	0.9	1	
Q_{gd}	Gate-Drain Charge ^{2,3}		---	1.6	3	
$T_{d(on)}$	Turn-On Delay Time ^{2,3}	$V_{DD}=-10V, V_{GS}=-4.5V, R_G=25\Omega$ $I_D=-1A$	---	5	9	nS
T_r	Rise Time ^{2,3}		---	17.4	33	
$T_{d(off)}$	Turn-Off Delay Time ^{2,3}		---	40.7	80	
T_f	Fall Time ^{2,3}		---	11.4	23	
C_{iss}	Input Capacitance	$V_{DS}=-10V, V_{GS}=0V, F=1\text{MHz}$	---	515	745	pF
C_{oss}	Output Capacitance		---	55	80	
C_{rss}	Reverse Transfer Capacitance		---	20	30	

Drain-Source Diode Characteristics and Maximum Ratings

Symbol	Parameter	Conditions	Min.	Typ.	Max.	Unit
I_S	Continuous Source Current	$V_G=V_D=0V$, Force Current	---	---	-4.1	A
I_{SM}	Pulsed Source Current		---	---	-16.4	A
V_{SD}	Diode Forward Voltage	$V_{GS}=0V, I_S=-1A, T_J=25^\circ\text{C}$	---	---	-1	V

Note :

1. Repetitive Rating : Pulsed width limited by maximum junction temperature.
2. The data tested by pulsed, pulse width $\leq 300\mu s$, duty cycle $\leq 2\%$.
3. Essentially independent of operating temperature.

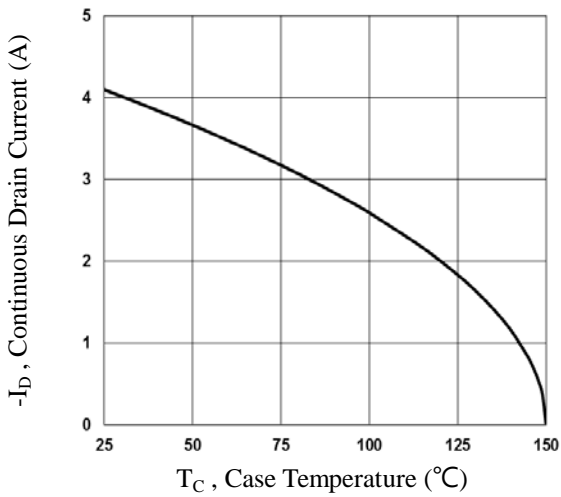

Fig.1 Continuous Drain Current vs. T_C

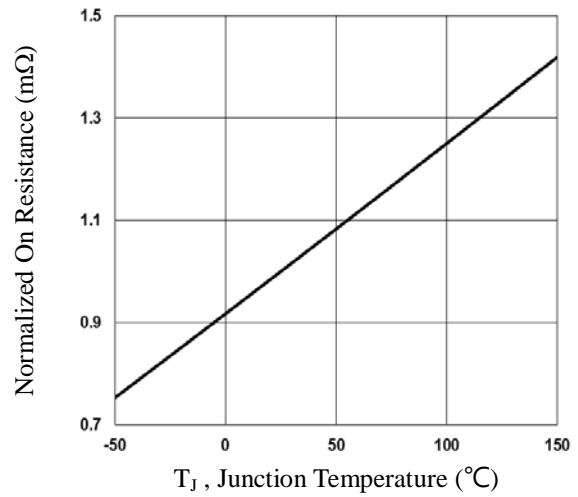

Fig.2 Normalized R_{DSon} vs. T_J

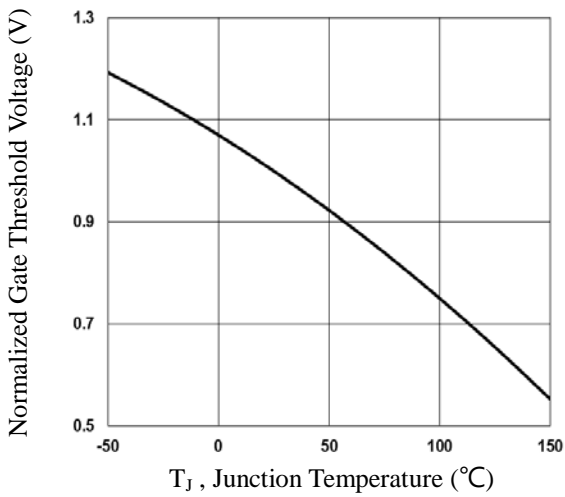

Fig.3 Normalized V_{th} vs. T_J

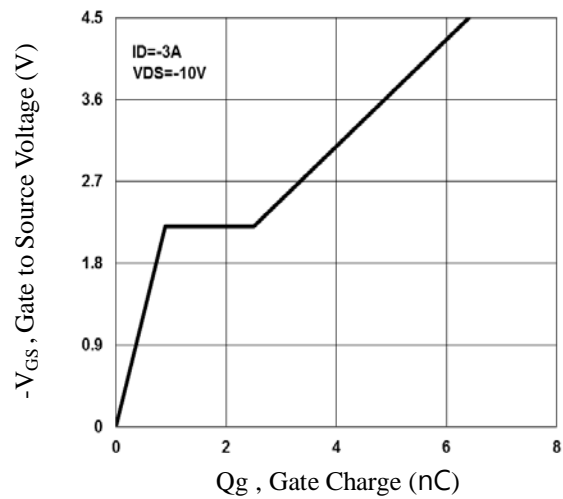

Fig.4 Gate Charge Waveform

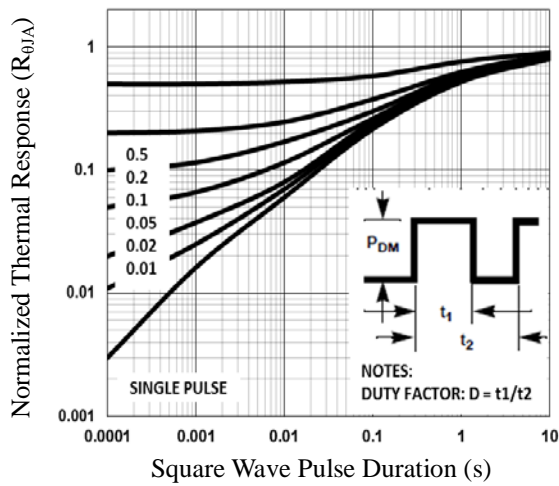

Fig.5 Normalized Transient Impedance

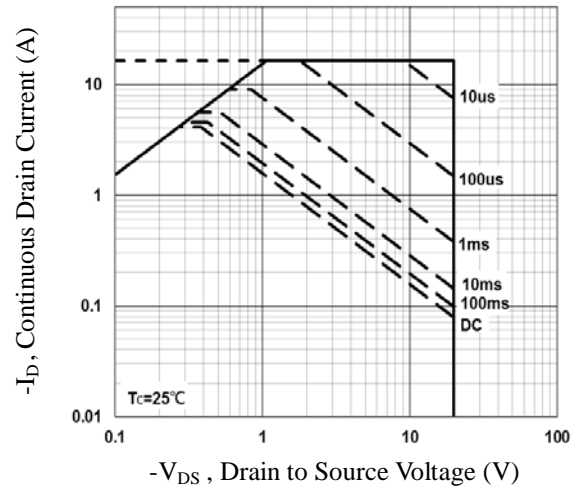

Fig.6 Maximum Safe Operation Area

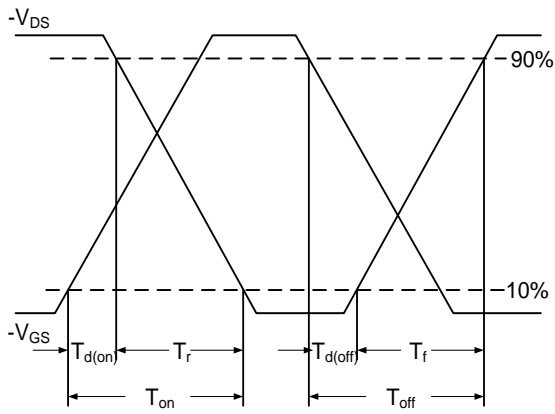

Fig.7 Switching Time Waveform

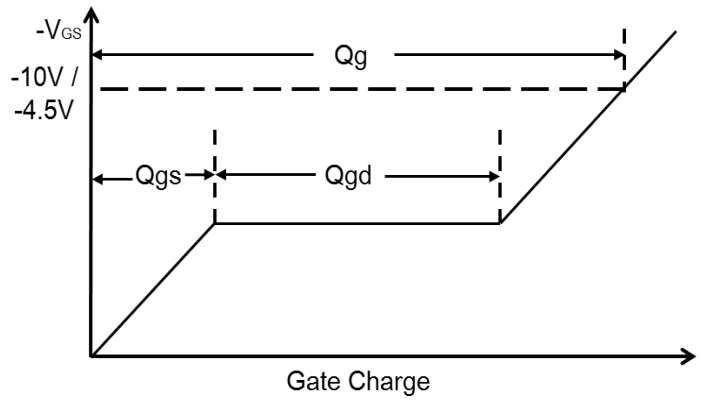
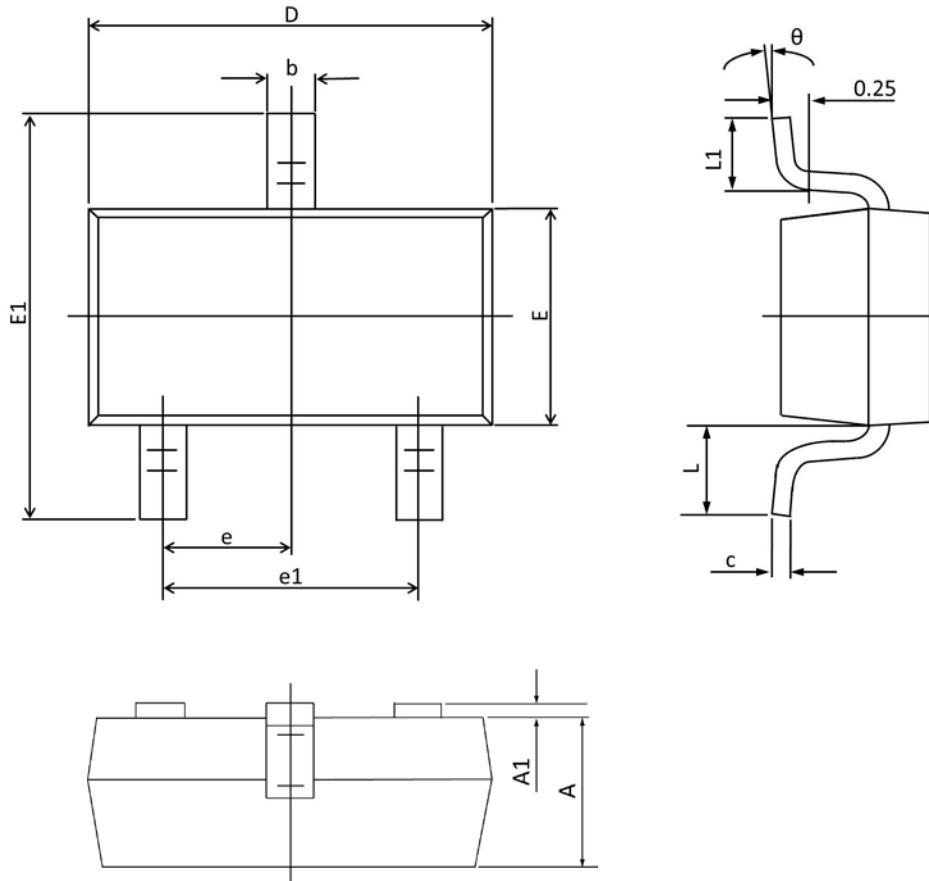

Fig.8 Gate Charge Waveform

SOT23-3S PACKAGE INFORMATION



Symbol	Dimensions In Millimeters		Dimensions In Inches	
	Min	Max	Min	Max
A	0.900	1.000	0.035	0.039
A1	0.000	0.100	0.000	0.004
b	0.300	0.500	0.012	0.020
c	0.090	0.110	0.003	0.004
D	2.800	3.000	0.110	0.118
E	1.200	1.400	0.047	0.055
E1	2.250	2.550	0.089	0.100
e	0.950 TYP.		0.037 TYP.	
e1	1.800	2.000	0.071	0.079
L	0.550 REF.		0.022 REF.	
L1	0.300	0.500	0.012	0.020
θ	1°	7°	1°	7°