

1N4728A-G SERIES

SILICON ZENER DIODE

VOLTAGE 3.3 to 75 Volt **POWER** 1 Watt

DO-41G Unit : inch(mm)

FEATURES

- Low inductance
- High temperature soldering : 260°C /10 seconds at terminals
- Glass package has Underwriters Laboratory Flammability Classification
- Lead free in compliance with EU RoHS 2011/65/EU directive

MECHANICAL DATA

- Case: Molded Glass DO-41G
- Terminals: Axial leads, solderable per MIL-STD-750, Method 2026
- Polarity: Color band denotes positive end
- Weight: 0.012 ounce, 0.317 gram

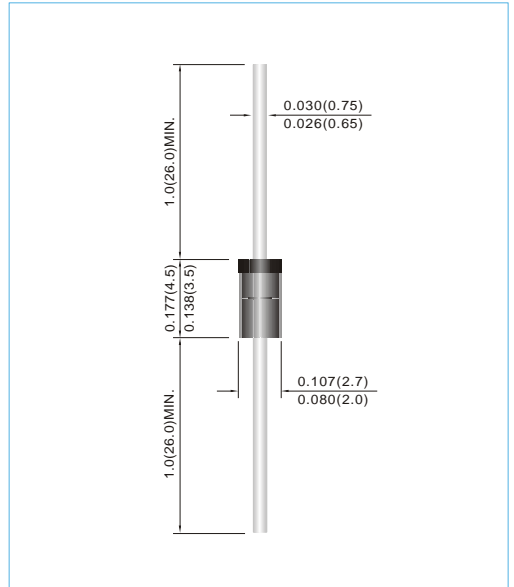
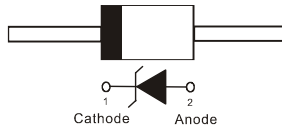

MAXIMUM RATINGS AND ELECTRICAL CHARACTERISTICS

Ratings at 25°C ambient temperature unless otherwise specified.

Parameter	Symbol	Value	Units
Power Dissipation at $T_A \leq 50^\circ\text{C}$	P_{TOT}	1*	W
Junction Temperature	T_J	-65 to +200	°C
Storage Temperature Range	T_{STG}	-65 to +200	°C

*Valid provided that leads at a distance of 10mm from case are kept at ambient temperature.

Parameter	Symbol	Min.	Typ.	Max.	Units
Thermal Resistance Junction to Ambient Air	$R_{\theta JA}$	--	--	170*	°C/W
Forward Voltage at $I_F = 200\text{mA}$	V_F	--	--	1.2	V

*Valid provided that leads at a distance of 10mm from case are kept at ambient temperature.

1N4728A-G SERIES

Part Number	Nominal Zener Voltage			Max. Zener Impedance				Maximum Leakage Current		Marking Code
	V _Z @ I _{ZT}			Z _{ZT} @ I _{ZT}		Z _{ZK} @ I _{ZK}		I _R @ V _R		
	Nom. V	Min. V	Max. V	Ω	mA	Ω	mA	μA	V	
1 Watt Zener Diodes										
1N4728A-G	3.3	3.14	3.47	10	76	400	1	100	1	1N4728A
1N4729A-G	3.6	3.42	3.78	10	69	400	1	100	1	1N4729A
1N4730A-G	3.9	3.71	4.1	9	64	400	1	50	1	1N4730A
1N4731A-G	4.3	4.09	4.52	9	58	400	1	10	1	1N4731A
1N4732A-G	4.7	4.47	4.94	8	53	500	1	10	1	1N4732A
1N4733A-G	5.1	4.85	5.36	7	49	550	1	10	1	1N4733A
1N4734A-G	5.6	5.32	5.88	5	45	600	1	10	2	1N4734A
1N4735A-G	6.2	5.89	6.51	2	41	700	1	10	3	1N4735A
1N4736A-G	6.8	6.46	7.14	3.5	37	700	1	5	4	1N4736A
1N4737A-G	7.5	7.13	7.88	4	34	700	0.5	5	5	1N4737A
1N4738A-G	8.2	7.79	8.61	4.5	31	700	0.5	5	6	1N4738A
1N4739A-G	9.1	8.65	9.56	5	28	700	0.5	0.5	7	1N4739A
1N4740A-G	10	9.5	10.5	7	25	700	0.25	0.5	7.6	1N4740A
1N4741A-G	11	10.45	11.55	8	23	700	0.25	0.1	8.4	1N4741A
1N4742A-G	12	11.4	12.6	9	21	700	0.25	0.1	9.1	1N4742A
1N4743A-G	13	12.35	13.65	10	19	700	0.25	0.1	9.9	1N4743A
1N4744A-G	15	14.25	15.75	14	17	700	0.25	0.1	11.4	1N4744A
1N4745A-G	16	15.2	16.8	16	15.5	700	0.25	0.1	12.2	1N4745A
1N4746A-G	18	17.1	18.9	20	14	750	0.25	0.1	13.7	1N4746A
1N4747A-G	20	19	21	22	12.5	750	0.25	0.1	15.2	1N4747A
1N4748A-G	22	20.9	23.1	23	11.5	750	0.25	0.1	16.7	1N4748A
1N4749A-G	24	22.8	25.2	25	10.5	750	0.25	0.1	18.2	1N4749A
1N4750A-G	27	25.65	28.35	35	9.5	750	0.25	0.1	20.6	1N4750A
1N4751A-G	30	28.5	31.5	40	8.5	1000	0.25	0.1	22.8	1N4751A
1N4752A-G	33	31.35	34.65	45	7.5	1000	0.25	0.1	25.1	1N4752A
1N4753A-G	36	34.2	37.8	50	7	1000	0.25	0.1	27.4	1N4753A
1N4754A-G	39	37.05	40.95	60	6.5	1000	0.25	0.1	29.7	1N4754A
1N4755A-G	43	40.85	45.15	70	6	1500	0.25	0.1	32.7	1N4755A
1N4756A-G	47	44.65	49.35	80	5.5	1500	0.25	0.1	35.8	1N4756A
1N4757A-G	51	48.45	53.55	95	5	1500	0.25	0.1	38.8	1N4757A
1N4758A-G	56	53.2	58.8	110	4.5	2000	0.25	0.1	42.6	1N4758A
1N4759A-G	62	58.9	65.1	125	4	2000	0.25	0.1	47.1	1N4759A
1N4760A-G	68	64.6	71.4	150	3.7	2000	0.25	0.1	51.7	1N4760A
1N4761A-G	75	71.25	78.75	175	3.3	2000	0.25	0.1	56	1N4761A

1N4728A-G SERIES

NOTE:

1. Tolerance and Type Number Designation. The type numbers listed have a standard tolerance on the nominal zener voltage of $\pm 5\%$
2. Specials Available Include:
 - A. Nominal zener voltages between the voltages shown and tighter voltage tolerances.
 - B. Matched sets.
3. Zener Voltage (V_Z) Measurement. Guarantees the zener voltage when measured at 90 seconds while maintaining the lead temperature (T_L) at $30^\circ\text{C} \pm 1^\circ\text{C}$, from the diode body.
4. Zener Impedance (Z_Z) Derivation. The zener impedance is derived from the 60 cycle ac voltage, which results when an ac current having an rms value equal to 10% of the dc zener current (I_{ZT} or I_{ZK}) is superimposed on I_{ZT} or I_{ZK} .
5. Surge Current (I_r) Non-Repetitive. The rating listed in the electrical characteristics table is maximum peak, non-repetitive, reverse surge current of 1/2

RATING AND CHARACTERISTICS CURVES

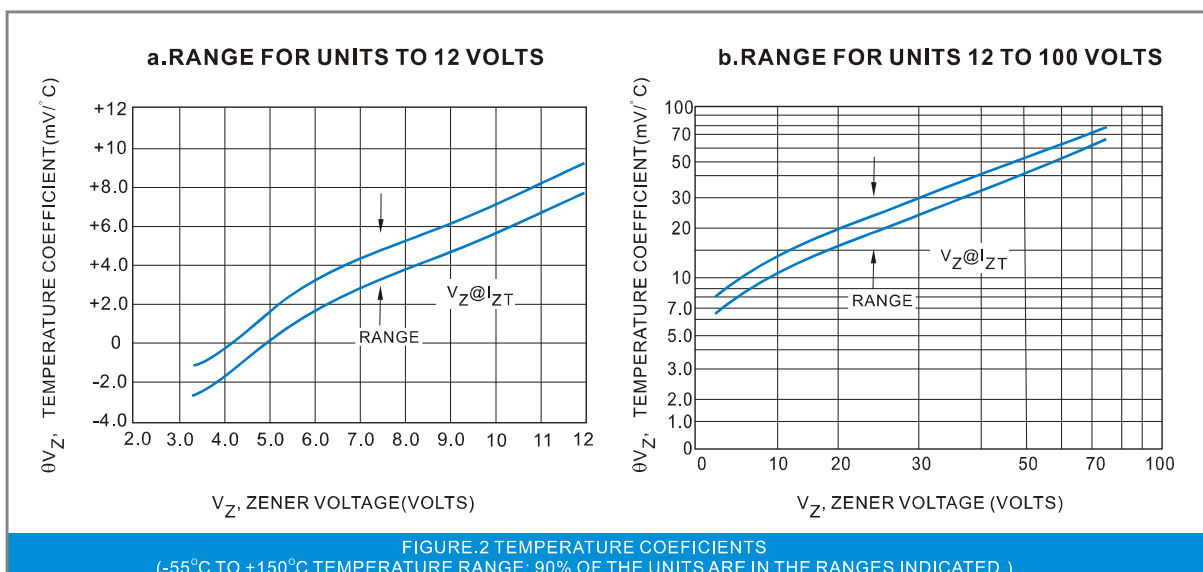
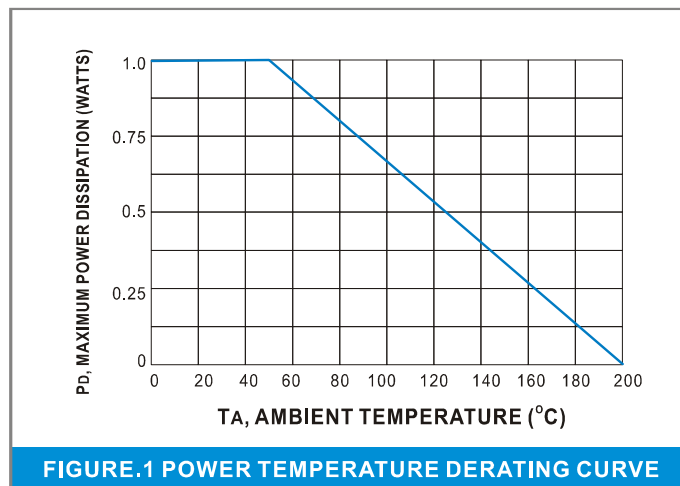

1N4728A-G SERIES

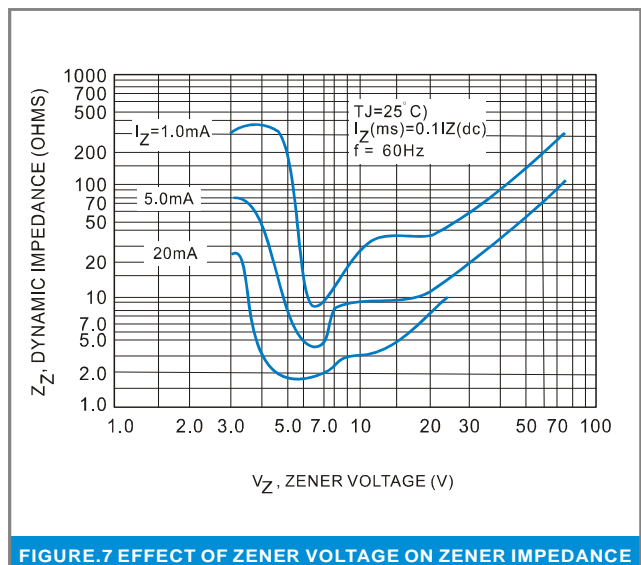
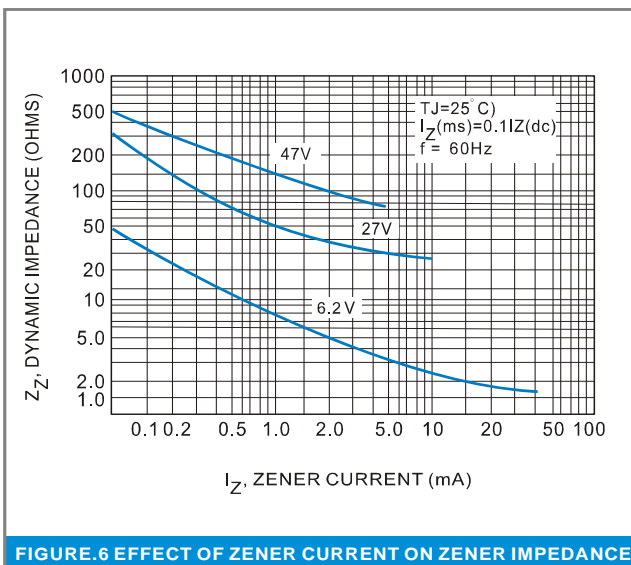
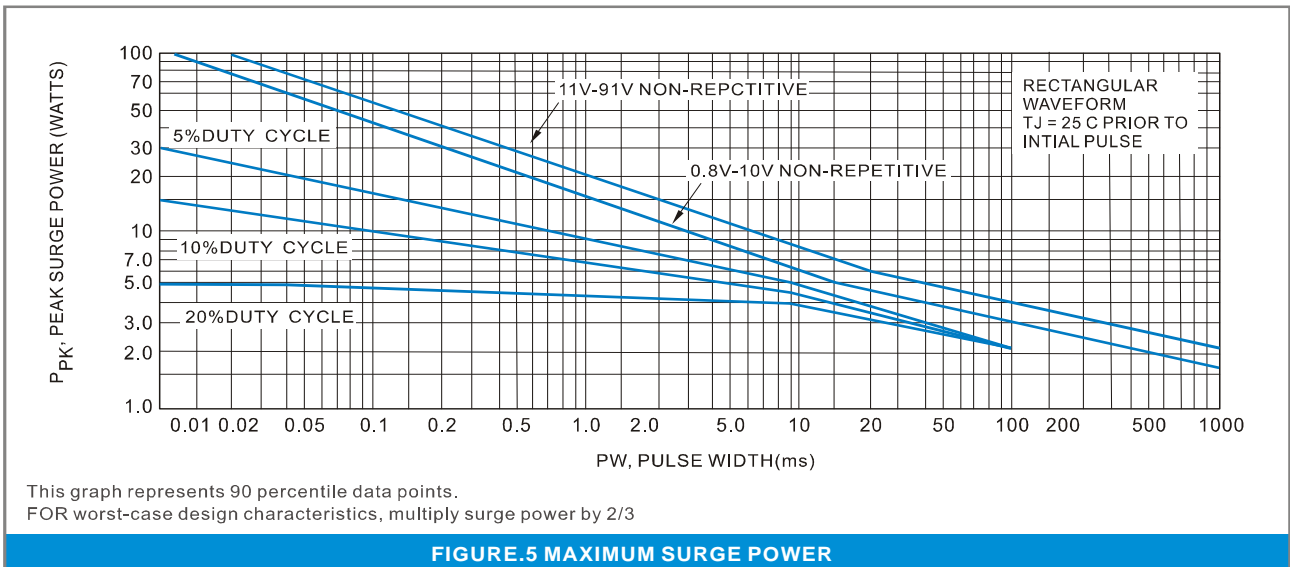
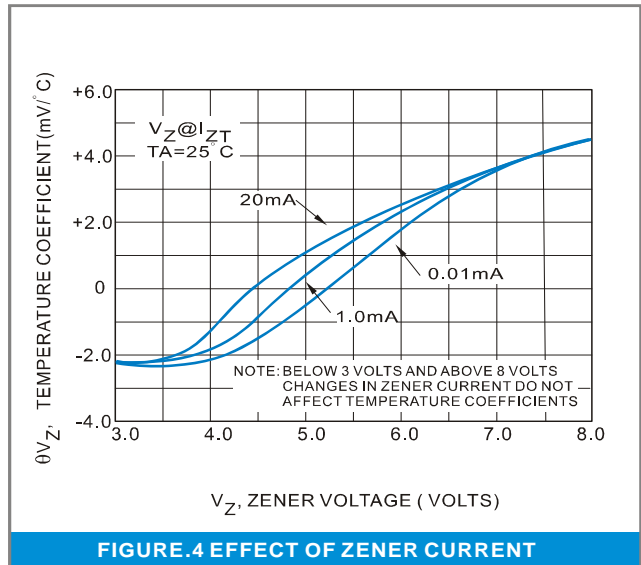
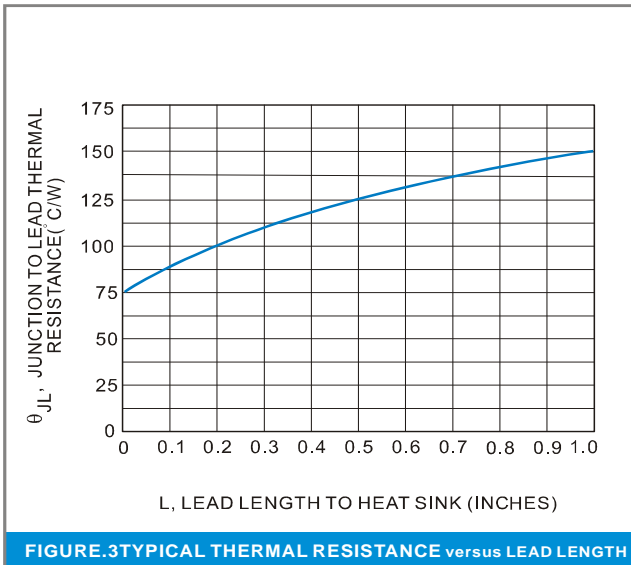

1N4728A-G SERIES

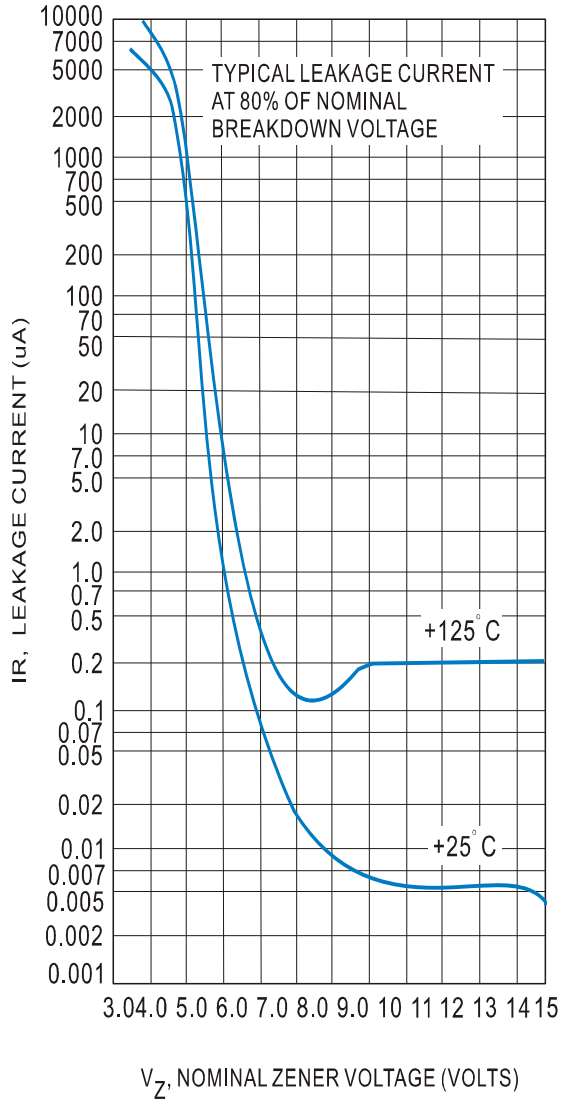

FIGURE.8 TYPICAL LEAKAGE CURRENT

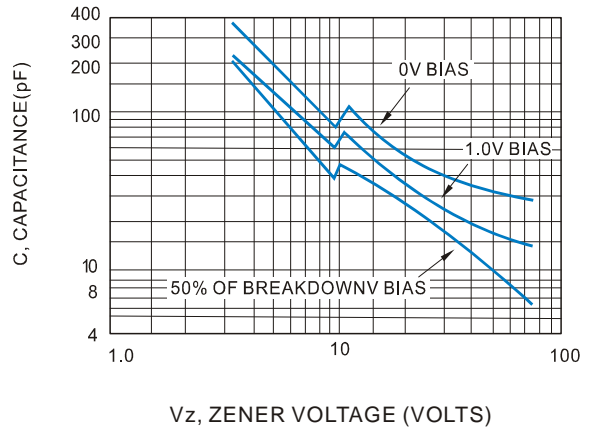

FIGURE.9 TYPICAL CAPACITANCE versus V_Z

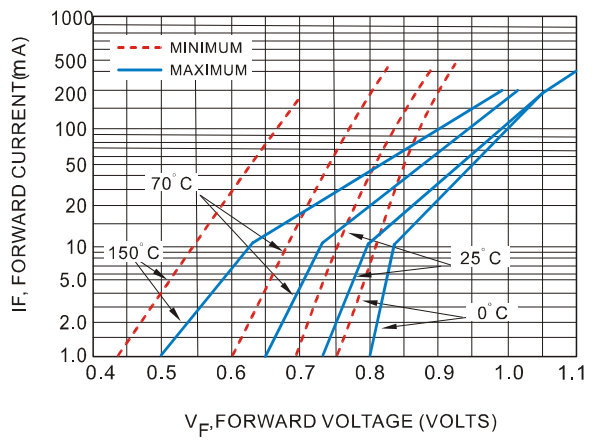

FIGURE.10 TYPICAL FORWARD CHARACTERISTICS

1N4728A-G SERIES

Part No_packing code_Version

1N4728A-G_AX_10001
1N4728A-G_AY_10001
1N4728A-G_BO_10001
1N4728A-G_R2_10001

For example :

RB500V-40_R2_00001

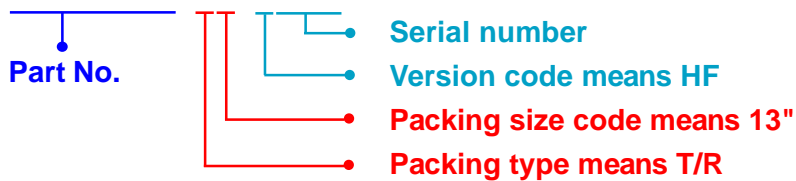

Packing type	Packing Code XX			HF or RoHS	Version Code XXXXX	
	1 st Code	Packing size code	2 nd Code		1 st Code	2 nd ~5 th Code
Tape and Ammunition Box (T/B)	A	N/A	0	HF	0	serial number
Tape and Reel (T/R)	R	7"	1	RoHS	1	serial number
Bulk Packing (B/P)	B	13"	2			
Tube Packing (T/P)	T	26mm	X			
Tape and Reel (Right Oriented) (TRR)	S	52mm	Y			
Tape and Reel (Left Oriented) (TRL)	L	PANASERT T/B CATHODE UP (PBCU)	U			
FORMING	F	PANASERT T/B CATHODE DOWN (PBCD)	D			

1N4728A-G SERIES

Disclaimer

- Reproducing and modifying information of the document is prohibited without permission from Panjit International Inc..
- Panjit International Inc. reserves the rights to make changes of the content herein the document anytime without notification. Please refer to our website for the latest document.
- Panjit International Inc. disclaims any and all liability arising out of the application or use of any product including damages incidentally and consequentially occurred.
- Panjit International Inc. does not assume any and all implied warranties, including warranties of fitness for particular purpose, non-infringement and merchantability.
- Applications shown on the herein document are examples of standard use and operation. Customers are responsible in comprehending the suitable use in particular applications. Panjit International Inc. makes no representation or warranty that such applications will be suitable for the specified use without further testing or modification.
- The products shown herein are not designed and authorized for equipments requiring high level of reliability or relating to human life and for any applications concerning life-saving or life-sustaining, such as medical instruments, transportation equipment, aerospace machinery et cetera. Customers using or selling these products for use in such applications do so at their own risk and agree to fully indemnify Panjit International Inc. for any damages resulting from such improper use or sale.
- Since Panjit uses lot number as the tracking base, please provide the lot number for tracking when complaining.